

# AG05, AG06

Actuator with CANopen interface

User manual



## Table of contents

<b>1</b>	<b>General Information .....</b>	<b>6</b>
1.1	Documentation.....	6
1.1.1	History.....	6
<b>2</b>	<b>Block Diagram.....</b>	<b>7</b>
<b>3</b>	<b>Display and Control Keys.....</b>	<b>7</b>
3.1	General.....	7
3.2	LCD display.....	8
3.3	LED displays.....	8
<b>4</b>	<b>Functional Description .....</b>	<b>8</b>
4.1	Control of the drive .....	8
4.1.1	Value input .....	8
4.1.2	Value selection .....	9
4.1.3	Operating modes.....	9
4.1.3.1	Positioning mode .....	9
4.1.3.1.1	Loop positioning.....	9
4.1.3.2	Inching operation.....	10
4.1.3.2.1	Inching mode 1 .....	10
4.1.3.2.2	Inching mode2 .....	11
4.1.3.3	Rotational speed mode.....	11
4.2	Manual control (stand-alone operation) .....	12
4.2.1	Start inching mode 2.....	12
4.2.2	Specifying the set point and starting the travel order.....	12
4.2.2.1	Example: Starting positioning order to position 500 .....	12
4.2.2.2	Example: Starting positioning order to position -500.....	12
4.3	Menu selection.....	14
4.3.1	Changeable parameters .....	15
4.3.1.1	Bus parameters .....	15
4.3.1.2	Positioning.....	16
4.3.1.3	Actuator.....	17
4.3.1.4	Limiting values .....	17
4.3.1.5	Visualization.....	18
4.3.1.6	Options.....	19
4.3.1.7	Controller parameters.....	21
4.3.2	Readable parameters .....	21
4.3.3	Error memory.....	22
4.4	Protective functions.....	22
4.4.1	Current limiting .....	22
4.4.2	Temperature monitoring.....	23
4.4.3	Oscillation detection .....	23
<b>5</b>	<b>Calibration.....</b>	<b>23</b>

<b>6</b>	<b>External gear</b>	<b>24</b>
<b>7</b>	<b>Warnings / Errors</b>	<b>24</b>
7.1	Warnings	24
7.2	Errors	24
7.2.1	Error codes	25
7.3	Input errors	26
<b>8</b>	<b>Parameter description</b>	<b>26</b>
<b>9</b>	<b>Communication via CAN bus</b>	<b>35</b>
9.1	General remarks	35
9.1.1	Interface	36
9.2	System Status Word	36
9.2.1	Meaning of the bits	36
9.3	CANopen protocol	38
9.3.1	Telegram setup	38
9.3.2	Network management (NMT)	39
9.3.2.1	State Diagramm	39
9.3.2.2	NMT Status 'INITIALISATION'	39
9.3.2.3	NMT Status 'PRE-OPERATIONAL'	40
9.3.2.4	NMT Status 'OPERATIONAL'	40
9.3.2.5	NMT Status 'STOPPED'	40
9.3.2.6	Switching between communication states	40
9.3.3	SYNC-Objekt	41
9.3.4	Process Data Objects (PDOs)	41
9.3.5	Transmit-PDOs	41
9.3.5.1	1 <sup>st</sup> Transmit PDO (TPDO1)	41
9.3.5.2	3 <sup>rd</sup> Transmit PDO (TPDO3)	41
9.3.5.3	4 <sup>th</sup> Transmit PDO (TPDO4)	42
9.3.5.4	Transfer types of the Transmit PDOs	42
9.3.6	Receive-PDOs	43
9.3.6.1	1 <sup>st</sup> Receive PDO (RPDO1)	43
9.3.6.2	3 <sup>rd</sup> Receive PDO (RPDO3)	43
9.3.6.3	4 <sup>th</sup> Receive PDO (RPDO4)	44
9.3.6.4	Transfer types of the Receive PDOs	44
9.3.7	Service Data Objects (SDOs)	45
9.3.7.1	Error code	46
9.3.8	Example: Parameterization	46
9.3.8.1	Example: Read parameter	46
9.3.8.2	Example: Write parameter	47
9.3.9	Emergency Object (EMCY)	48
9.3.9.1	Error Code	48
9.3.10	Heartbeat protocol	51
9.3.11	Node Guarding	51

9.4	State Machine .....	52
9.5	Status word .....	54
9.6	Control word .....	56
9.7	Flowchart of the Profile Position Mode (positioning mode) .....	59
9.8	Flowchart of the Profile Velocity Mode operation mode (velocity mode).....	60
9.9	Examples.....	60
9.9.1	Example of the Profile Position Mode (positioning mode) .....	60
9.9.2	Example of the Profile Velocity Mode (velocity mode).....	61
9.10	Overview of CANopen identifiers .....	62
9.11	Setting the CAN baud rate .....	62
9.12	EDS file.....	62
9.13	Directory of objects .....	62
9.13.1	Overview of objects.....	63
9.13.2	Description of objects.....	66
9.13.2.1	1000 <sub>h</sub> : Device Type .....	66
9.13.2.2	1001 <sub>h</sub> : Error Register .....	66
9.13.2.3	1002 <sub>h</sub> : Manufacturer Status Register.....	67
9.13.2.4	1003 <sub>h</sub> : Pre-defined Error Field.....	67
9.13.2.5	1005 <sub>h</sub> : COB-ID Sync Message .....	68
9.13.2.6	1008 <sub>h</sub> : Manufacturer Device Name .....	68
9.13.2.7	100A <sub>h</sub> : Manufacturer Software Version .....	69
9.13.2.8	100C <sub>h</sub> : Guard Time .....	69
9.13.2.9	100D <sub>h</sub> : Life Time Factor .....	70
9.13.2.10	1011 <sub>h</sub> : Restore Default Parameters .....	70
9.13.2.11	1014 <sub>h</sub> : COB-ID Emergency Message.....	72
9.13.2.12	1017 <sub>h</sub> : Producer Heartbeat Time.....	72
9.13.2.13	1018 <sub>h</sub> : Identity Object.....	73
9.13.2.14	1200 <sub>h</sub> : Server SDO Parameter .....	74
9.13.2.15	1400 <sub>h</sub> : 1 <sup>st</sup> Receive PDO Parameter.....	75
9.13.2.16	1401 <sub>h</sub> : 2 <sup>nd</sup> Receive PDO Parameter .....	77
9.13.2.17	1402 <sub>h</sub> : 3 <sup>rd</sup> Receive PDO Parameter.....	78
9.13.2.18	1403 <sub>h</sub> : 4 <sup>th</sup> Receive PDO Parameter.....	80
9.13.2.19	1600 <sub>h</sub> : 1 <sup>st</sup> Receive PDO Mapping Parameter .....	82
9.13.2.20	1601 <sub>h</sub> : 2 <sup>nd</sup> Receive PDO Mapping Parameter.....	82
9.13.2.21	1602 <sub>h</sub> : 3 <sup>rd</sup> Receive PDO Mapping Parameter .....	83
9.13.2.22	1603 <sub>h</sub> : 4 <sup>th</sup> Receive PDO Mapping Parameter .....	84
9.13.2.23	1800 <sub>h</sub> : 1 <sup>st</sup> Transmit PDO Parameter .....	85
9.13.2.24	1801 <sub>h</sub> : 2 <sup>nd</sup> Transmit PDO Parameter.....	87
9.13.2.25	1802 <sub>h</sub> : 3 <sup>rd</sup> Transmit PDO Parameter .....	88
9.13.2.26	1803 <sub>h</sub> : 4 <sup>th</sup> Transmit PDO Parameter .....	90
9.13.2.27	1A00 <sub>h</sub> : 1 <sup>st</sup> Transmit PDO Mapping Parameter.....	93
9.13.2.28	1A01 <sub>h</sub> : 2 <sup>nd</sup> Transmit PDO Mapping Parameter .....	93
9.13.2.29	1A02 <sub>h</sub> : 3 <sup>rd</sup> Transmit PDO Mapping Parameter .....	94
9.13.2.30	1A03 <sub>h</sub> : 4 <sup>th</sup> Transmit PDO Mapping Parameter .....	95

9.13.2.31 2001 <sub>h</sub> : Manufacturer Offset.....	96
9.13.2.32 2100 <sub>h</sub> : CAN baud rate .....	96
9.13.2.33 2101 <sub>h</sub> : Node-ID .....	97
9.13.2.34 2102 <sub>h</sub> : Gear reduction .....	97
9.13.2.35 2400 <sub>h</sub> : Display and Operation Parameter Set .....	97
9.13.2.36 2410 <sub>h</sub> : Motor Parameter Set.....	101
9.13.2.37 2412 <sub>h</sub> : Spindle Pitch .....	104
9.13.2.38 2413 <sub>h</sub> : Pos Type.....	104
9.13.2.39 2415 <sub>h</sub> : Delta Jog.....	105
9.13.2.40 2416 <sub>h</sub> : Stop Mode Inching Mode 2.....	105
9.13.2.41 2417 <sub>h</sub> : Inpos Mode.....	105
9.13.2.42 2418 <sub>h</sub> : Loop Length.....	106
9.13.2.43 2419 <sub>h</sub> : Contouring Error Limit.....	106
9.13.2.44 241A <sub>h</sub> : Contouring Error.....	106
9.13.2.45 241B <sub>h</sub> : Power Supply Voltage.....	107
9.13.2.46 241C <sub>h</sub> : Output Stage Temperature.....	107
9.13.2.47 241E <sub>h</sub> : Motor Current.....	108
9.13.2.48 2421 <sub>h</sub> : Motor Current Limit.....	108
9.13.2.49 2423 <sub>h</sub> : Battery Voltage .....	108
9.13.2.50 2424 <sub>h</sub> : Motor Thermal Load .....	109
9.13.2.51 2450 <sub>h</sub> : Inching 2 Offset .....	109
9.13.2.52 2451 <sub>h</sub> : Type of acceleration Inching mode 2 .....	109
9.13.2.53 2500 <sub>h</sub> : Production Date .....	110
9.13.2.54 2501 <sub>h</sub> : Display Software Version .....	110
9.13.2.55 2900 <sub>h</sub> : Error Counters .....	110
9.13.2.56 6040 <sub>h</sub> : Control word .....	111
9.13.2.57 6041 <sub>h</sub> : Status word .....	112
9.13.2.58 6060 <sub>h</sub> : Modes of Operation.....	112
9.13.2.59 6061 <sub>h</sub> : Modes of Operation Display .....	113
9.13.2.60 6064 <sub>h</sub> : Position Actual Value .....	113
9.13.2.61 6067 <sub>h</sub> : Position Window.....	114
9.13.2.62 606C <sub>h</sub> : Velocity Actual Value.....	114
9.13.2.63 607A <sub>h</sub> : Target Position.....	114
9.13.2.64 607C <sub>h</sub> : Calibration Value .....	115
9.13.2.65 607D <sub>h</sub> : Software Position Limit .....	115
9.13.2.66 607E <sub>h</sub> : Polarity .....	116
9.13.2.67 6091 <sub>h</sub> : Gear Ratio .....	116
9.13.2.68 60FF <sub>h</sub> : Target Velocity.....	117

## 1 General Information

This user manual is valid with firmware version PC 2.04 or higher!

### 1.1 Documentation

The following documents are associated with this document:

- The data sheet describes the technical data, the dimensions, the pin assignment, the accessories and the order key.
- The installation instructions describe the mechanical and electrical installation with all safety-relevant conditions and the associated technical specifications.
- The User manual for actuator commissioning and integration into a fieldbus system.

You can also download these documents at <http://www.siko-global.com/p/ag05>.

#### 1.1.1 History

Change	Date	Description
049/21	26.03.2021	from PC FW-V2.05 Manuals AG05 and AG06 combined Chapter <a href="#">1.1.1 History</a> new Chapter <a href="#">4.4 Protective functions</a> new Chapter <a href="#">7.2.1 Error codes</a> extends Chapter <a href="#">8 Parameter description Parameter 75 - Parameter 99</a> new Chapter <a href="#">9.3.9.1 Error Code</a> extends Chapter <a href="#">9.13.2.50 2424h: Motor Thermal Load</a> new Chapter <a href="#">9.13.2.55 2900h: Error Counters</a> new Adjustments and corrections

## 2 Block Diagram

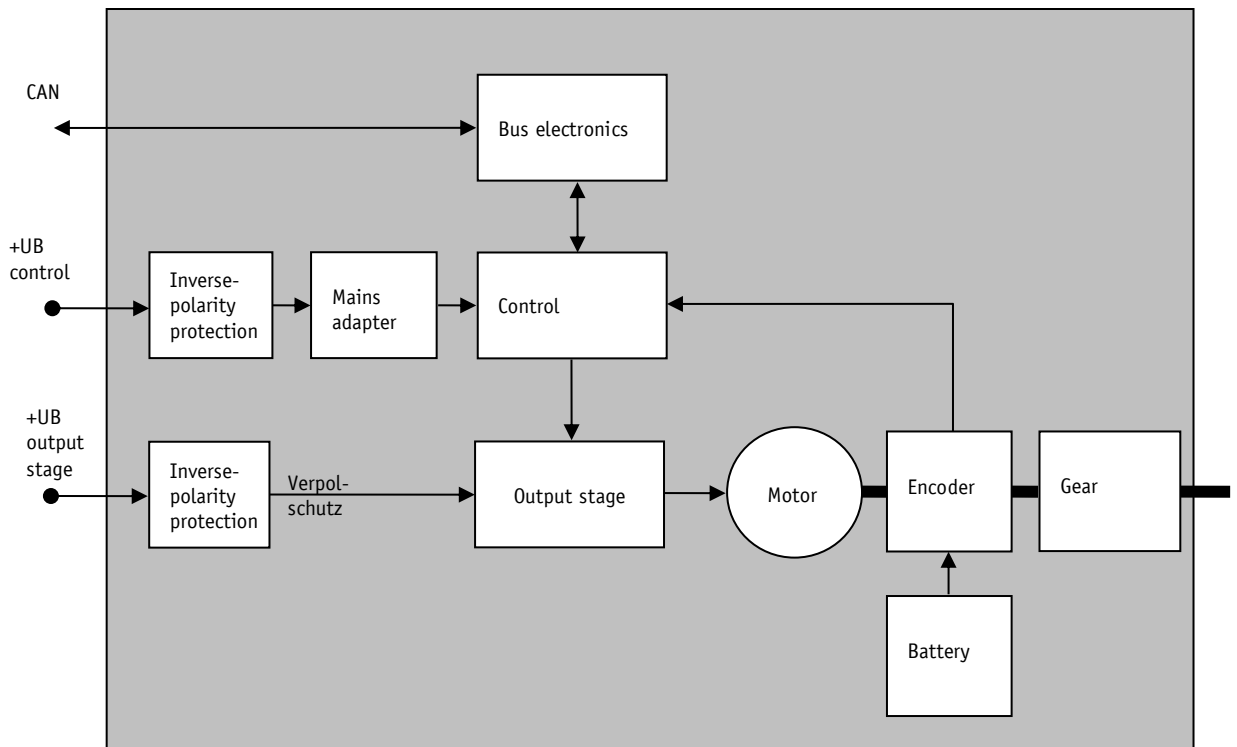

Fig. 1: Block diagram

## 3 Display and Control Keys

### 3.1 General

The actuator has a two-line display with special characters and three control keys. The keys serve for actuator parameterization and control. Two LEDs (1, 2) inform about the actuator's operating state.

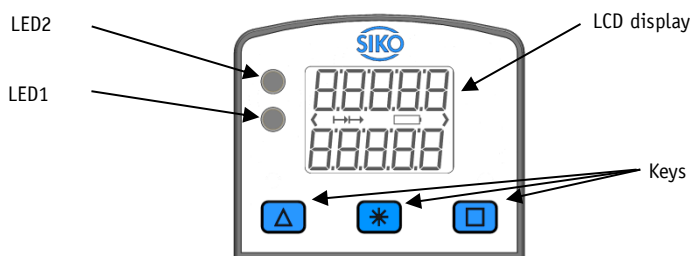

Fig. 2: Control elements

### 3.2 LCD display

With supply voltage applied to the control, the actual value is displayed in the first line and the set point value with factory settings in the second line.

The value displayed in the 2<sup>nd</sup> line can be adjusted via parameters.

### 3.3 LED displays

LED	Colour	State	Description
LED1	green	on	Actuator is within the programmed position window. Supply voltage of the output stage is applied.
		blinking	Actuator is within the programmed position window. Supply voltage of the output stage is missing.
		off	Actuator is outside the programmed position window.
	red	on	Actuator is outside the programmed position window. Supply voltage of the output stage is applied.
		blinking	Actuator is outside the programmed position window. Supply voltage of the output stage is missing.
		off	Actuator is within the programmed position window.
LED2	orange	blinking 2.5 Hz	NMT state: 'PRE-OPERATIONAL'
		on	NMT state: 'OPERATIONAL'
		blinking pulse-duty factor 1:5	
		off	NMT state: 'STOPPED'



Table 1: LED displays

## 4 Functional Description

### 4.1 Control of the drive

The drive can be controlled manually (stand-alone) and completely parameterized via the keys. In bus operation you can disable drive control via the keys.

#### 4.1.1 Value input

Enter values via the  key and the  key. Confirm entered values by pressing the  key.

 - Decimal place selection key

 - Value input key

<b>NOTICE</b>	With value input via the keys, the display range is limited to -19999 ... 99999. When entering values beyond this range via CAN interface, "FULL" will be displayed when you select the parameter.
---------------	--



### 4.1.2 Value selection

For some parameters you can select values from a list. Direct value input is not possible.

You can select a value from the list via the  $\Delta$  key. Confirm the value by pressing the  $*$  key.

### 4.1.3 Operating modes

The following operating modes are distinguished: positioning mode and speed mode. In the positioning mode there is the additional option of travelling in the inching mode.

#### 4.1.3.1 Positioning mode

In the positioning mode, positioning to the specified set point is executed by means of a ramp function (see Fig. 3), calculated on the basis of the actual position as well as the programmed controller parameters P (proportional factor), I (integral factor), D (differential factor), acceleration and speed.

Upon activation of the travel order, the actuator accelerates to the specified speed with the acceleration programmed. The value of deceleration to the set point is defined by the parameter 'a-Pos' as well.

If the actual position is within the programmed window, this will be signalled by LED1, in the system status word and in the CAN status word. You can define the behaviour of the actuator upon reaching the programmed window.

Changing controller parameters during a positioning process does not influence the current positioning operation.

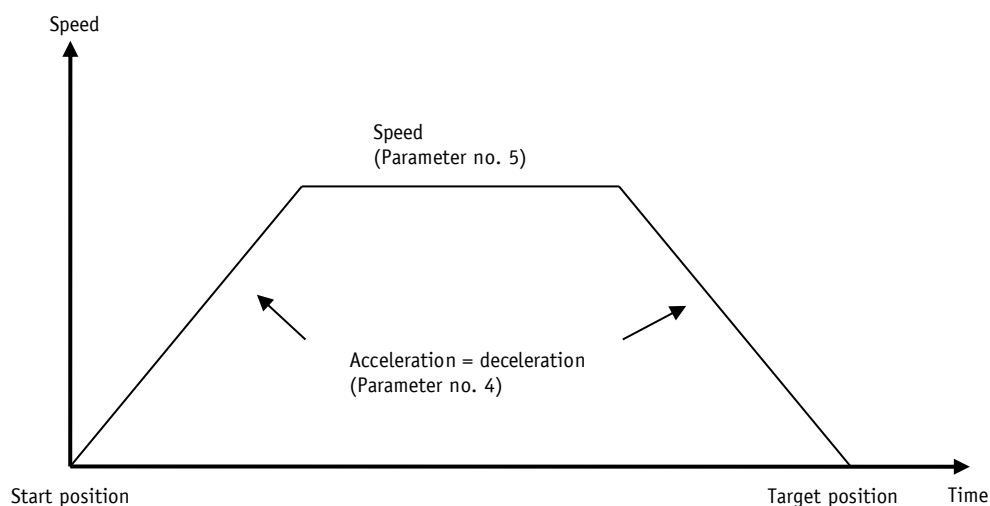

Fig. 3: Ramp travel, direct positioning mode

#### 4.1.3.1.1 Loop positioning

If the actuator is operated on a spindle or an additional gear, the spindle or external gear backlash can be compensated by means of loop positioning. In this case, travelling to the target value is always from the same direction. This direction of approach can be defined.

**Example:**

The direction from which every target position shall be driven to is positive.

- Case 1  $\Rightarrow$  new position is greater than actual position:  
Direct travel to the target position
- Case 2  $\Rightarrow$  new position is smaller than actual position:  
The actuator drives beyond the target position by the loop length; afterwards, the set point is approached in positive direction.

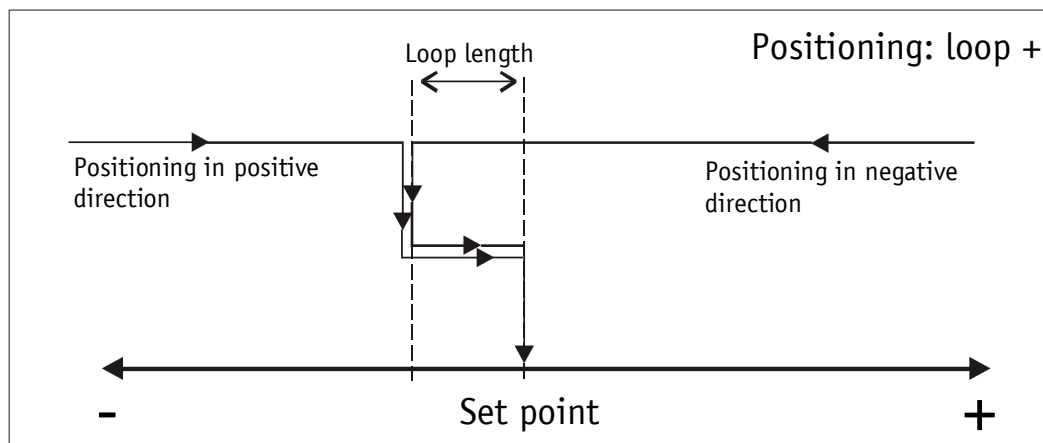

Fig. 4: Positioning Loop+

#### 4.1.3.2 Inching operation

Inching operation is enabled in the 'positioning mode' only. You can program via parameters acceleration as well as speed in the inching mode.

**NOTICE**

There is no compensation for spindle play (loop positioning) in this operating mode.

##### 4.1.3.2.1 Inching mode 1

The drive travels once from the current actual position by the position 'Delta Tipp' depending on the mathematical sign of the value entered.

'Delta Tipp' <0: negative travel direction

'Delta Tipp' >0: positive travel direction

**NOTICE**

If the 'Spindle pitch' parameter is programmed to zero, then the travelling way occurs by increments. If 'Spindle pitch' is unequal zero, then the information of the 'Delta Tipp' parameter refers to the travel distance in 1/100 mm.

Reaching of the target position will be signalled accordingly.

The following conditions must be met for enabling the start of inching modes 1 and 2:

- The actuator must not be switched to error
- No active travel job

- Supply voltage of the output stage is applied

**NOTICE**

If the actual position is outside the programmed limiting values, then travelling from this position in the respective direction is possible by means of inching mode 1 or 2!

#### 4.1.3.2.2 Inching mode2

The actuator travels from the current position as long as the relevant command is active. You can influence the inching speed via two parameters and it will be calculated in the actuator as illustrated in the example below:

$v$  - Tipp (Parameter no. 9) = 10 rpm (can only be changed in the idle state)

Offset inching 2 (Parameter no. 30) = 85 % (can be changed during inching operation)

The resulting inching speed in this example will be:

Inching speed =  $v$  - Tipp \* Offset inching 2 = 10 rpm \* 85 % = 9 rpm

The results are always rounded to integers. The minimum speed is 1 rpm.

#### 4.1.3.3 Rotational speed mode

With the set point enabled, the actuator when in the rotational speed mode accelerates to the target speed and maintains this speed until the set point is disabled or a different target speed specified.

The speed is adjusted immediately to the new value when the rotational target speed is changed.

The arithmetical sign of the set point determines the travel direction in the rotational speed mode.

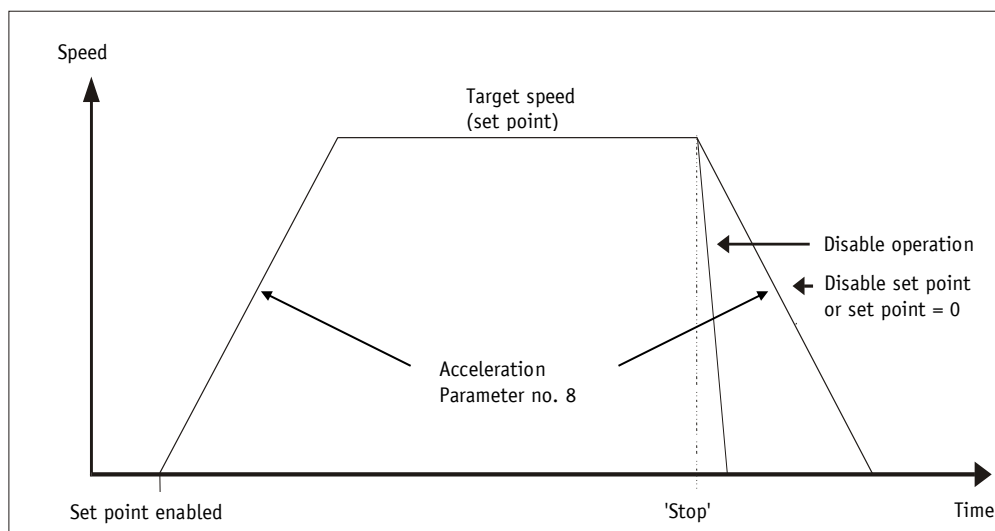

Fig. 5: Ramp rotational speed mode

The following conditions must be met for enabling the start of the rotational speed mode:

- The actuator must not be switched to error

- No active travel job
- Supply voltage of the output stage is applied

<b>NOTICE</b>	Limits 1 + 2 are inactivated in this operational mode.
---------------	--

## 4.2 Manual control (stand-alone operation)

### 4.2.1 Start inching mode 2

After applying supply voltage, the actuator will be on the uppermost level of the menu structure (default/delivery state). Positioning mode is active.

Pressing the  key starts left-hand motion (inching operation 2).

Pressing the  key starts right-hand motion (inching operation 2).

Releasing the respective key stops travel movement.















Pressing the  key starts the parameterization/programming mode.

### 4.2.2 Specifying the set point and starting the travel order

#### 4.2.2.1 Example: Starting positioning order to position 500

Preconditions:

- The display is at the uppermost level of the menu structure (basic state).
- Operating mode: Positioning mode
- Key functions: enabled







 	Initial state: normal display First press the  key, then the  key and hold down together.
 	The key enable time is counted down.
 	After expiry of the key enable time, the input field is released. The first decimal place is active. Press the  key twice to change the active decimal place.
 	The third decimal place is active. Press the  key 5 times.
 	Value 500 will be displayed. Confirm by pressing the  key to start positioning.

#### 4.2.2.2 Example: Starting positioning order to position -500

Preconditions:

- The display is at the uppermost level of the menu structure (basic state).
- Operating mode: Positioning mode
- Key functions: enabled

<b>NOTICE</b>	For negative values to be entered, set first the value and only afterwards the arithmetical sign. The value 0 cannot be entered.
---------------	--

0 0	Initial state: normal display First press the  key, then the  key and hold down together.
tA-r-9t 3	The key enable time is counted down.
tA-r-9t 00000	After expiry of the key enable time, the input field is released The first decimal place is active and blinks. Press the  key twice to change the active decimal place.
tA-r-9t 00000	The third decimal place is active and blinks. Press the  key 5 times for entering the value.
tA-r-9t 00500	Value 500 will be displayed. Press the  key twice to change the active decimal place.
tA-r-9t 00500	The fifth decimal place is active and blinks. Press the  key 11 times for setting the arithmetical sign.
tA-r-9t -0500	Value -500 will be displayed. Confirm by pressing the  key to start positioning.

### 4.3 Menu selection

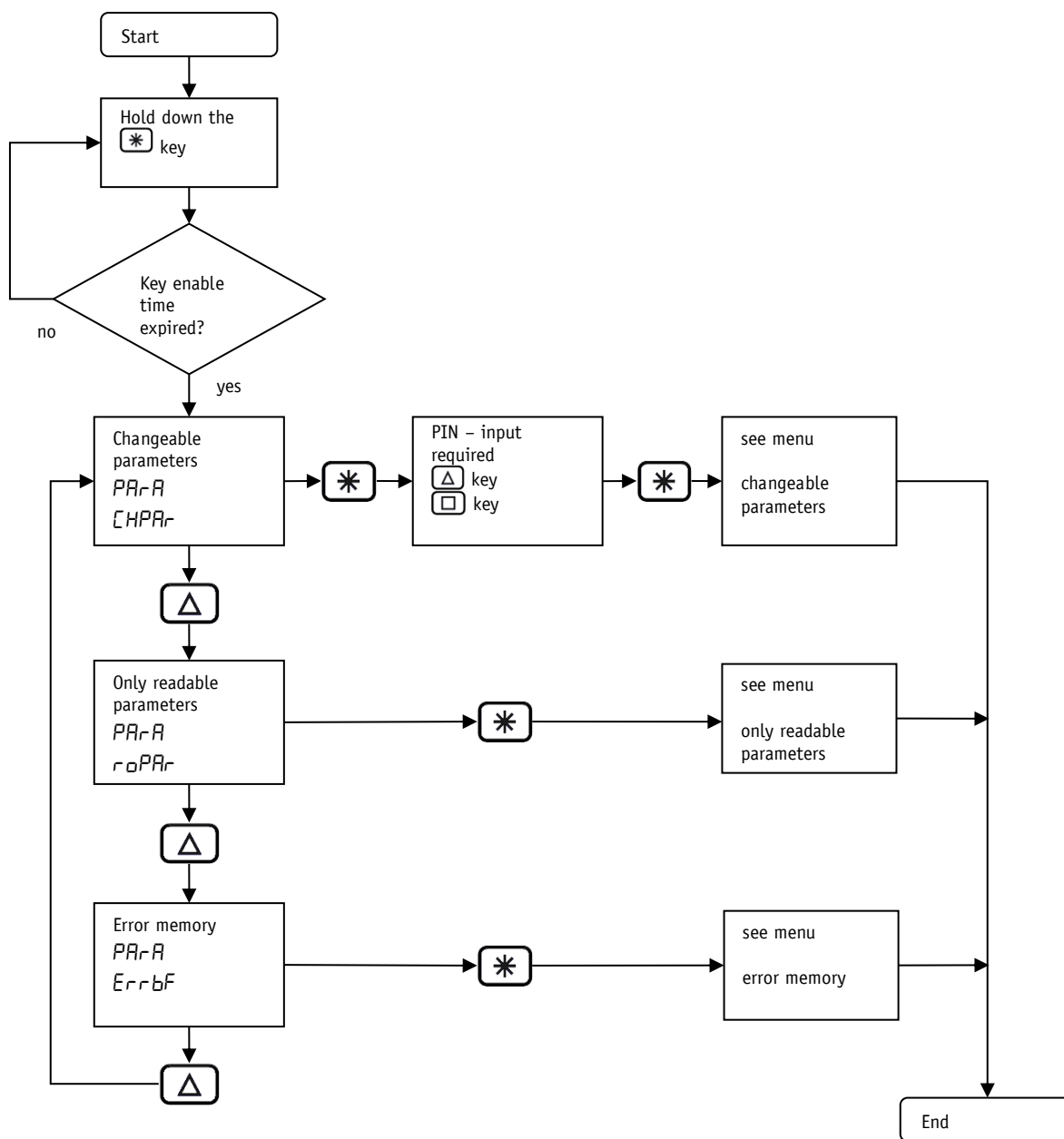

Fig. 6: Menu selection

### 4.3.1 Changeable parameters

The Changeable parameters menu is subdivided into further sub-menus:

Menu	Sub-menu	Description
PARA [HPAR	PARA BUS	Bus parameters
	PARA POSIT	Positioning
	PARA DRU	Actuator
	PARA BOUND	Limiting values
	PARA VISID	Visualization
	PARA OPTID	Options
	PARA CONTR	Controller parameter
	PARA QUIT	Exit menu

Table 2: Changeable parameters menu overview

#### 4.3.1.1 Bus parameters

Menu	PARA [HPAR	Sub-menu	PARA BUS
------	---------------	----------	-------------

Parameter	Description
Id	Node address Value range: 1 - 127 (see chapter 8: <a href="#">Parameter description</a> ⇒ <a href="#">Parameter no. 22</a> )
BAUD	Baud rate Selection: 1000: 1 Mbit/s 800: 800 kbit/s 500: 500 kbit/s 250: 250 kbit/s 125: 125 kbit/s 50: 50 kbit/s 20: 20 kbit/s (see chapter 8: <a href="#">Parameter description</a> ⇒ <a href="#">Parameter no. 33</a> )

Table 3: Bus parameter menu

## 4.3.1.2 Positioning

Menu	PPRP CHPPR	Sub-menu	PPRP POS It
------	---------------	----------	----------------

Parameter	Description
EAR9t	Pos window Value range: 0 - 1000 (see chapter 8: <a href="#">Parameter description</a> ⇒ <a href="#">Parameter no. 10</a> )
P ItCH	Spindle pitch Value range: 0 - 99999 (see chapter 8: <a href="#">Parameter description</a> ⇒ <a href="#">Parameter no. 13</a> )
d IU	Display divisor Selection: I: 1 I0: 10 I00: 100 I000: 1000 (see chapter 8: <a href="#">Parameter description</a> ⇒ <a href="#">Parameter no. 43</a> )
CAL Ib	Calibration value Value range: -19999 ... 99999 (see chapter 8: <a href="#">Parameter description</a> ⇒ <a href="#">Parameter no. 14</a> )
LOADP	Selection: no: no calibration CAL Ib: Execute calibration
OFFSt	Offset Value range: -19999 ... 99999 (see chapter 8: <a href="#">Parameter description</a> ⇒ <a href="#">Parameter no. 32</a> )
rotAt	Sense of rotation Selection: Cr: i sense of rotation (cw) CCr: e sense of rotation (ccw) (see chapter 8: <a href="#">Parameter description</a> ⇒ <a href="#">Parameter no. 18</a> )
POtYP	Pos Type Selection: d Ir: direct POS: loop+ nE9: loop- (see chapter 8: <a href="#">Parameter description</a> ⇒ <a href="#">Parameter no. 19</a> )
LOOP	Loop length Value range: 0 – 30000 (see chapter 8: <a href="#">Parameter description</a> ⇒ <a href="#">Parameter no. 27</a> )

Table 4: Positioning menu



## 4.3.1.3 Actuator

Menu	PARA [HPAR	Sub-menu	PARA drU
------	---------------	----------	-------------

Parameter	Description
A POS	Acceleration in the positioning mode Value range: 1 - 100 (see chapter 8: <a href="#">Parameter description</a> ⇒ <a href="#">Parameter no. 4</a> )
U POS	Maximum speed in the positioning mode Gear 66:1 ⇒ value range: 1 - 75 Gear 98:1 ⇒ value range: 1 - 50 (see chapter 8: <a href="#">Parameter description</a> ⇒ <a href="#">Parameter no. 5</a> )
A rot	Acceleration in rotational speed mode Value range: 1 - 100 (see chapter 8: <a href="#">Parameter description</a> ⇒ <a href="#">Parameter no. 6</a> )
A InC	Acceleration in inching mode 1/2 Value range: 1 - 100 (see chapter 8: <a href="#">Parameter description</a> ⇒ <a href="#">Parameter no. 8</a> )
U InC	Maximum speed in inching mode 1/2 Gear 66:1 ⇒ value range: 1 - 75 Gear 98:1 ⇒ value range: 1 - 50 (see chapter 8: <a href="#">Parameter description</a> ⇒ <a href="#">Parameter no. 9</a> )
gtrou	Numerator gear ratio Value range: 1 - 10000 (see chapter 8: <a href="#">Parameter description</a> ⇒ <a href="#">Parameter no. 11</a> )
gtrdE	Denominator gear ratio Value range: 1 - 10000 (see chapter 8: <a href="#">Parameter description</a> ⇒ <a href="#">Parameter no. 12</a> )

Table 5: Actuator menu

## 4.3.1.4 Limiting values

Menu	PARA [HPAR	Sub-menu	PARA bound
------	---------------	----------	---------------

Parameter	Description
EndP1	Limit 1 Value range: -19999 ... 99999 (see chapter 8: <a href="#">Parameter description</a> ⇒ <a href="#">Parameter no. 15</a> )
EndP2	Limit 2 Value range: -19999 ... 99999 (see chapter 8: <a href="#">Parameter description</a> ⇒ <a href="#">Parameter no. 16</a> )

Parameter	Description
$\epsilon_{or9E}$	Current limiting Value range: 25 - 110 (see chapter 8: <a href="#">Parameter description</a> ⇒ <a href="#">Parameter no. 29</a> )
$\epsilon_{ont}$	Contouring error limit Value range: 1 - 30000 (see chapter 8: <a href="#">Parameter description</a> ⇒ <a href="#">Parameter no. 28</a> )

Table 6: Limiting values menu

#### 4.3.1.5 Visualization

Menu	$PARA$ $CHPAR$	Sub-menu	$PARA$ $U1510$
------	-------------------	----------	-------------------

Parameter	Description
$d15PL$	Display orientation Selection: $0$ : 0° $180$ : 180° (see chapter 8: <a href="#">Parameter description</a> ⇒ <a href="#">Parameter no. 45</a> )
$ORA 2$	LED 2 orange function Selection: $on$ : Bus operation display $OFF$ : Off (see chapter 8: <a href="#">Parameter description</a> ⇒ <a href="#">Parameter no. 39</a> )
$red 1$	Red LED 1 function Selection: $on$ : Indication of the operating status $OFF$ : Off (see chapter 8: <a href="#">Parameter description</a> ⇒ <a href="#">Parameter no. 40</a> )
$grn 1$	Green LED 1 function Selection: $on$ : Indication of the operating status $OFF$ : Off (see chapter 8: <a href="#">Parameter description</a> ⇒ <a href="#">Parameter no. 41</a> )
$dEC 1$	Decimal places Selection: $0$ : 0 $01$ : 0.0 $002$ : 0.00 $0003$ : 0.000 $00004$ : 0.0000 (see chapter 8: <a href="#">Parameter description</a> ⇒ <a href="#">Parameter no. 42</a> )

Parameter	Description
<i>Ind IC</i>	Direction indication function Selection: <i>ON</i> : On <i>INVS</i> : inverted <i>OFF</i> : Off (see chapter 8: <a href="#">Parameter description</a> ⇒ <a href="#">Parameter no. 44</a> )
<i>L InE2</i>	Displayed value of 2 <sup>nd</sup> display line Selection: <i>SPt</i> : Set point <i>dEG</i> : Output stage temperature <i>CVoLt</i> : Control voltage <i>PVoLt</i> : Output stage voltage <i>Ubat</i> : Battery voltage <i>I drc</i> : Motor current <i>POS</i> : Actual position <i>VELD</i> : Actual rotational speed (see chapter 8: <a href="#">Parameter description</a> ⇒ <a href="#">Parameter no. 49</a> )
<i>tESt</i>	Display test Selection: <i>no</i> : no display test <i>YES</i> : Start display test, pressing the  key stops display test.

Table 7: Visualization menu

#### 4.3.1.6 Options

Menu	<i>PARA</i> <i>CHPAR</i>	Sub-menu	<i>PARA</i> <i>OPT IO</i>
------	-----------------------------	----------	------------------------------

Parameter	Description
<i>cdELt</i>	Key enable time Value range: 1 - 60 (see chapter 8: <a href="#">Parameter description</a> ⇒ <a href="#">Parameter no. 37</a> )
<i>bUttEn</i>	Key function enable Selection: <i>ON</i> : Enable all key functions <i>OFF</i> : All key functions disabled (see chapter 8: <a href="#">Parameter description</a> ⇒ <a href="#">Parameter no. 38</a> )
<i>OPtYP</i>	Operating mode Selection: <i>POS</i> : Positioning mode <i>VELD</i> : Rotational speed mode (see chapter 8: <a href="#">Parameter description</a> ⇒ <a href="#">Parameter no. 20</a> )

Parameter	Description
<i>d InCH</i>	Delta Inch Value range: -19999 ... 99999 (see chapter 8: <a href="#">Parameter description</a> ⇒ <a href="#">Parameter no. 17</a> )
<i>InPOS</i>	Inpos mode Selection: <i>ENTRL</i> : Position control to set point <i>SHORt</i> : Position control Off and short circuit of all motor windings <i>FR EE</i> : Position control Off and drive enable (see chapter 8: <a href="#">Parameter description</a> ⇒ <a href="#">Parameter no. 26</a> )
<i>AtYP</i>	Inching mode 2 acceleration type Selection: <i>StAt</i> : static acceleration <i>dYn</i> : incremental acceleration (see chapter 8: <a href="#">Parameter description</a> ⇒ <a href="#">Parameter no. 31</a> )
<i>StoP2</i>	Stop mode inching 2 Selection: <i>HRd</i> : stop with maximum deceleration <i>SOFt</i> : stop with programmed deceleration (see chapter 8: <a href="#">Parameter description</a> ⇒ <a href="#">Parameter no. 25</a> )
<i>Offn2</i>	Inching 2 Offset Value range: 10 - 100 (see chapter 8: <a href="#">Parameter description</a> ⇒ <a href="#">Parameter no. 30</a> )
<i>Pin</i>	PIN change Value range: 0 - 99999 (see chapter 8: <a href="#">Parameter description</a> ⇒ <a href="#">Parameter no. 48</a> )
<i>LOADP</i>	S commands Selection: <i>no</i> : execute no S command <i>ALL</i> : Set all parameters to default <i>StAnd</i> : Set standard parameters to default <i>dr lUE</i> : Set controller parameters to default <i>d ISPL</i> : Set display parameters to default <i>bUS</i> : Set bus parameters to default <i>CAL Ib</i> : Calibration <i>dLErr</i> : Delete error memory

Table 8: Options menu

### 4.3.1.7 Controller parameters

Menu	PARA CHPAR	Sub-menu	PARA Contr
------	---------------	----------	---------------

Parameter	Description
CPAR-P	Controller parameter P Value range: 1 - 500 (see chapter 8: <a href="#">Parameter description</a> ⇒ <a href="#">Parameter no. 1</a> )
CPAR-I	Controller parameter I Value range: 0 - 500 (see chapter 8: <a href="#">Parameter description</a> ⇒ <a href="#">Parameter no. 2</a> )
CPAR-D	Controller parameter D Value range: 0 - 500 (see chapter 8: <a href="#">Parameter description</a> ⇒ <a href="#">Parameter no. 3</a> )

Table 9: Controller parameters menu

### 4.3.2 Readable parameters

Menu	PARA roPAR
------	---------------

Parameter	Description
dEG	Current output stage temperature
CUoLt	Current control voltage
PUoLt	Current output stage voltage
UBAtt	Current battery voltage
i dru	Current motor current
PQS	Current actual position
VELD	Current actual speed
rEDUC	Gear reduction
P dru	Motor rated power
EnCRE	Encoder resolution
U LEd	Display controller software version
U dru	Motor controller software version
SERno	Serial number
dProd	Production date

Table 10: Readable parameters menu

### 4.3.3 Error memory

Menu	PARA ErrbF
------	---------------

Parameter	Description
Errno 0	Number of errors in the error memory (see chapter 8: <a href="#">Parameter description</a> ⇒ <a href="#">Parameter no. 61</a> )
Err 1 xxxxx	Error 1 (see chapter 8: <a href="#">Parameter description</a> ⇒ <a href="#">Parameter no. 62</a> )
Err 2 xxxxx	Error 2 (see chapter 8: <a href="#">Parameter description</a> ⇒ <a href="#">Parameter no. 63</a> )
Err 3 xxxxx	Error 3 (see chapter 8: <a href="#">Parameter description</a> ⇒ <a href="#">Parameter no. 64</a> )
Err 4 xxxxx	Error 4 (see chapter 8: <a href="#">Parameter description</a> ⇒ <a href="#">Parameter no. 65</a> )
Err 5 xxxxx	Error 5 (see chapter 8: <a href="#">Parameter description</a> ⇒ <a href="#">Parameter no. 66</a> )
Err 6 xxxxx	Error 6 (see chapter 8: <a href="#">Parameter description</a> ⇒ <a href="#">Parameter no. 67</a> )
Err 7 xxxxx	Error 7 (see chapter 8: <a href="#">Parameter description</a> ⇒ <a href="#">Parameter no. 68</a> )
Err 8 xxxxx	Error 8 (see chapter 8: <a href="#">Parameter description</a> ⇒ <a href="#">Parameter no. 69</a> )
Err 9 xxxxx	Error 9 (see chapter 8: <a href="#">Parameter description</a> ⇒ <a href="#">Parameter no. 70</a> )
Err 10 xxxxx	Error 10 (see chapter 8: <a href="#">Parameter description</a> ⇒ <a href="#">Parameter no. 71</a> )

Table 11: Error memory menu

xxxxx = Plain text display of error codes (see chapter 7.2.1: [Error codes](#))

## 4.4 Protective functions

### 4.4.1 Current limiting

The actuator is equipped with adjustable current limiting, which serves primarily for protecting the actuator against overload.

With the default value set, the nominal speed indicated on the data sheet is achieved.

Actuator overload results in limiting the motor current to the set value.

As a consequence, the actuator cannot maintain the speed set, the contouring error increases. With the contouring error exceeding the contouring error limit the actuator will enter the state of error: contouring error.

<b>NOTICE</b>	The actual motor current cannot be stated by measuring the supply current. With cycled output stages, the supply current does not correspond to the motor current. The actual motor current can be read out via the interface or indicated on the display.
---------------	--

#### 4.4.2 Temperature monitoring

<b>NOTICE</b>	The actuator does not have the thermal memory preservation. Switching off the operating voltage control after the thermal monitoring of the motor has responded (fault: motor thermal overload) resets the thermal memory. In this case, the actuator must cool down completely before restarting to ensure motor protection. Otherwise, the motor may be thermally destroyed.
---------------	--

The motor temperature is calculated from the motor current using a thermal model. The calculated thermal load can be set via the parameter Motor thermal load (see Chapter 8: [Parameter description](#) ⇒ [Parameter Nr. 75](#)) can be read out. If the load reaches 100%, the motor thermal overload fault is triggered.

The power stage temperature is measured directly in the power stage. If the measured temperature exceeds the value of 90 °C, the power stage overtemperature fault is triggered.

#### 4.4.3 Oscillation detection

If the PID positioning controller is operated outside the stability limit, the axis of the actuator may start oscillating. At standstill and simultaneously active position control (no travel job active), it is monitored whether oscillations occur at the axis. If the oscillations exceed a defined threshold value, the Position control unstable fault is triggered.

## 5 Calibration

Since the measuring system is an absolute system, calibration is necessary only once with commissioning. With calibration, the calibration value is adopted for calculation of the position value. The following equation is applied in case of calibration:

Position value = 0 + calibration value + offset value

Writing a value onto the calibration value parameter (see chapter 8: [Parameter description](#) ⇒ [Parameter no.14](#)) will result in the adoption of such value as the absolute position for the actuator.

Offset value (see chapter 8: [Parameter description](#) ⇒ [Parameter no. 32](#))

<b>NOTICE</b>	Calibration is only possible when no travel job is active!
---------------	--

## 6 External gear

If an external gear is used, a factor can be programmed via the parameters no. 11 'ü – numerator' and parameter no. 12 'ü – denominator' in order to include the gear ratio in position sensing.

Example (see Fig. 7):

The actuator is operated on a gear with transmission reduction of 5:1. For this purpose, the parameters 'ü-numerator' and 'ü-denominator' must be programmed as follows:

- Parameter 'ü – numerator': 5
- Parameter 'ü – denominator': 1

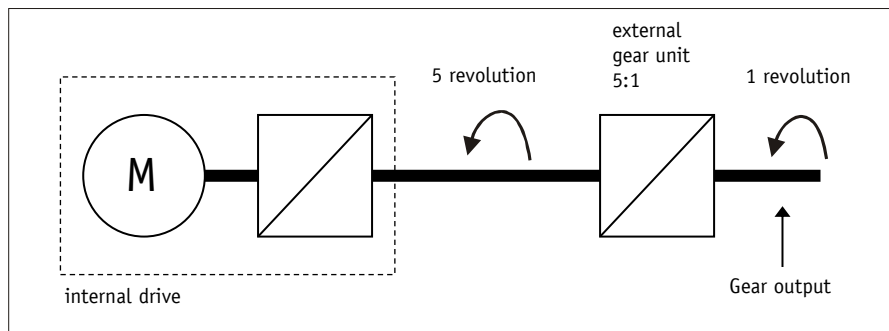

Fig. 7: External gear

Input of an odd gear transmission reduction value is possible according to the following example:

Transmission reduction = 3.78

- Parameter 'ü – numerator': 378
- Parameter 'ü – denominator': 100

## 7 Warnings / Errors

### 7.1 Warnings

Warnings do not influence the operation of the positioning drive. Warnings disappear after removing the cause.

Possible warnings:

- Battery voltage for absolute encoder is below limit  $\Rightarrow$  exchange battery within the next 6 months.
- Current limiting active.

### 7.2 Errors

Errors cause an immediate stop of the positioning drive. Error states are signalled via display.

Via interface errors can also be detected:



- The error messages are entered in the error memory in the order of their detection. The last 10 error messages are displayed when the error memory is full.
- The cause of error can be tracked down with the help of the error codes.

Each fault is stored in the assigned fault counter. The fault counters cannot be reset.

### 7.2.1 Error codes

Display	EMCY- Error codes	Error
<i>noErr</i>	00 00 <sub>h</sub>	No error
<i>toCLI</i>	FF 04 <sub>h</sub>	Timeout client
<i>toHDS</i>	FF 05 <sub>h</sub>	Timeout host
<i>cSCLI</i>	FF 06 <sub>h</sub>	Check sum client
<i>cSHDS</i>	FF 07 <sub>h</sub>	Check sum host
<i>dEFI n</i>	FF 08 <sub>h</sub>	Define mismatch
<i>bAtt</i>	FF 09 <sub>h</sub>	Low battery voltage
<i>CUuLt</i>	32 21 <sub>h</sub>	Low control electronics voltage
<i>CoULt</i>	32 11 <sub>h</sub>	Excess control electronics voltage
<i>POuLt</i>	32 12 <sub>h</sub>	Excess power electronics voltage
<i>ouEr t</i>	43 10 <sub>h</sub>	Output stage excess temperature
<i>LAG</i>	86 11 <sub>h</sub>	Contouring error
<i>bLoc</i>	71 21 <sub>h</sub>	Shaft blocked
<i>noSUP</i>	32 22 <sub>h</sub>	Power electronics: not supplied
<i>btYPE</i>	FF 0A <sub>h</sub>	Unknown bus type
<i>Si nCO</i>	73 00 <sub>h</sub>	SIN COS monitoring error
<i>q1our</i>	FF 0B <sub>h</sub>	Queue 1 overrun
<i>q2our</i>	FF 0C <sub>h</sub>	Queue 2 overrun
<i>qUES t</i>	FF 0D <sub>h</sub>	Response doesn't match question
<i>CSEEP</i>	FF 0E <sub>h</sub>	Check sum EEPROM
<i>ErPAS</i>	FF 02 <sub>h</sub>	Error Passive state occurred during an active travel job.
<i>bUSOF</i>	FF 03 <sub>h</sub>	Bus Off status
<i>q3our</i>	FF 0F <sub>h</sub>	Queue 3 overrun
<i>q4our</i>	FF 10 <sub>h</sub>	Queue 4 overrun
<i>CAnou</i>	81 10 <sub>h</sub>	CAN overrun
<i>ouEr C</i>	FF 11 <sub>h</sub>	Motor overcurrent
<i>PI dUS</i>	FF 12 <sub>h</sub>	Position control unstable
<i>oLORd</i>	FF 13 <sub>h</sub>	Motor thermal overload

Table 12: Error codes

### 7.3 Input errors

Input errors inform the user about errors that occurred during menu entries. Entries that produce errors are not adopted. Input errors are not saved in the error memory.

Display	Description
U <del>ALUE</del>	Value range exceeded / inappropriate
L <del>I UP</del>	Input value exceeds upper limit
L <del>I LO</del>	Input value exceeds lower limit
A <del>CCES</del>	Access not supported
P <del>r 2-r 0</del>	Write on read only
r <del>d 2P0</del>	Read on write only
S <del>tAtE</del>	Error caused by device status
b <del>USY</del>	Input disabled due to ongoing EEPROM write access
d <del>JAct</del>	Input disabled due to active travelling job
n <del>oPrG</del>	Programming lock activated

## 8 Parameter description

Column	Explanation
S	"S" = Parameter transferred is saved in the device non-volatilely "- " = Parameter transferred is saved in the device volatilely
C	Parameter class 1 = Standard parameter 2 = Controller parameter 3 = Display parameter 4 = Bus parameter 5 = general parameter

No.	Name	Selection / value	Default	Description	S	C
1	Controller parameter P	1 - 500	300	<b>P gain of controller:</b> valid for all operating modes (positioning mode, speed mode, inching mode)	S	2
2	Controller parameter I	0 - 500	2	<b>I gain of controller:</b> valid for all operating modes (positioning mode, speed mode, inching mode)	S	2
3	Controller parameter D	0 - 500	0	<b>D gain of controller:</b> valid for all operating modes (positioning mode, speed mode, inching mode)	S	2

No.	Name	Selection / value	Default	Description	S	C
4	a - pos	1 - 100	50	<b>Acceleration in the positioning mode:</b> values in % 100 % correspond to: Gear 66:1 $\Rightarrow$ 3.04 rps <sup>2</sup> Gear 98:1 $\Rightarrow$ 2.05 rps <sup>2</sup> Gear 188:1 $\Rightarrow$ 1.06 rps <sup>2</sup> Gear 368:1 $\Rightarrow$ 0.54 rps <sup>2</sup>	S	2
5	v - pos	see Description column	10	<b>Maximum speed in the positioning mode:</b> values in rpm Gear 66:1 $\Rightarrow$ 1 - 75 rpm Gear 98:1 $\Rightarrow$ 1 - 50 rpm Gear 188:1 $\Rightarrow$ 1 - 30 rpm Gear 368:1 $\Rightarrow$ 1 - 15 rpm	S	2
6	a - rot	1 - 100	50	<b>Acceleration in rotational speed mode:</b> values in % 100 % correspond to: Gear 66:1 $\Rightarrow$ 3.04 rps <sup>2</sup> Gear 98:1 $\Rightarrow$ 2.05 rps <sup>2</sup> Gear 188:1 $\Rightarrow$ 1.06 rps <sup>2</sup> Gear 368:1 $\Rightarrow$ 0.54 rps <sup>2</sup>	S	2
7				reserved		
8	a - inch	1 - 100	50	<b>Acceleration in inching mode 1/2:</b> values in % 100 % correspond to: Gear 66:1 $\Rightarrow$ 3.04 rps <sup>2</sup> Gear 98:1 $\Rightarrow$ 2.05 rps <sup>2</sup> Gear 188:1 $\Rightarrow$ 1.06 U/s <sup>2</sup> Gear 368:1 $\Rightarrow$ 0.54 U/s <sup>2</sup>	S	2
9	v - inch	see Description column	10	<b>Maximum speed in inching mode 1/2:</b> values in rpm Gear 66:1 $\Rightarrow$ 1 - 75 rpm Gear 98:1 $\Rightarrow$ 1 - 50 rpm Gear 188:1 $\Rightarrow$ 1 - 30 rpm Gear 368:1 $\Rightarrow$ 1 - 15 rpm	S	2
10	Pos window	0 - 1000	10	<b>Operating mode: Positioning mode:</b> Positioning window If the actual position of the actuator is within the programmed set point $\pm$ this window, this is signalled by setting bit 3 in the status word of the actuator. Spindle pitch = 0: Values refer to increments Spindle pitch > 0: Values refer to travel distance in 1/100 mm <b>Operating mode: Speed mode:</b> If the actual rotational speed is within the target rotational speed $\pm$ this window, this is signalled by setting bit 3 in the system status word of the actuator.	S	1

No.	Name	Selection / value	Default	Description	S	C
11	ü - numerator	1 - 10000	1	<b>Numerator gear ratio:</b> a gear factor can be programmed here when a gear is used.	S	1
12	ü - denominator	1 - 10000	1	<b>Denominator gear ratio:</b> a gear factor can be programmed here when a gear is used.	S	1
13	Spindle pitch	0 - 1000000	0	<b>Spindle pitch:</b> Spindle pitch parameter = 0: Position value is output in increments (720 increments per revolution of the driving shaft). Spindle pitch parameter > 0: (when operating the actuator on a spindle) The position value is output as travelling distance in 1/100 mm , not in increments. Input of target position is now in 1/100 mm as well. e. g. spindle with a pitch of 2 mm ⇒ Spindle pitch parameter = 200.	S	1
14	Calibration value	-999999 to 999999	0	<b>Calibration value:</b> Changes in the calibration value will be directly adopted for the calculation of the position value. Position value = 0 + calibration value + offset value	S	1
15	Limit 1	-9999999 to 9999999	99999	<b>Operating mode: Positioning mode: Limit 1</b> Spindle pitch = 0: Values refer to increments Spindle pitch > 0: Values refer to travelling distance in 1/100 mm If actuator's position is beyond the range defined by limit 1 and limit 2 (travel range), travelling will only be possible in inching mode in the direction of the travel range. <b>Notice!</b> Limit monitoring is deactivated if 'limit 1' is equal 'limit 2'. Please note that there is a jump of the actual position if the resolution of the absolute encoder is exceeded! <b>Operating mode: Speed mode:</b> irrelevant	S	1

No.	Name	Selection / value	Default	Description	S	C
16	Limit 2	-9999999 to 9999999	-19999	<p><b>Operating mode: Positioning mode: Limit 2</b>            Spindle pitch = 0: Values refer to increments            Spindle pitch &gt; 0: Information refers to travel distance in 1/100 mm            If actuator's position is beyond the range defined by limit 1 and limit 2 (travel range), travelling will only be possible in inching mode in the direction of the travel range.  <b>Notice!</b> Limit monitoring is deactivated if 'limit 1' is equal 'limit 2'. Please note that there is a jump of the actual position if the resolution of the absolute encoder is exceeded!  <b>Operating mode: Speed mode:</b>            irrelevant</p>	S	1
17	Delta inch	-1000000 to 1000000	720	<p><b>Delta travelling distance with inching operation 1:</b>            Indicates the relative travelling distance.            positive value ⇒ positive travelling direction            negative value ⇒ negative travelling direction            Spindle pitch = 0: Values refer to increments            Spindle pitch &gt; 0: Information refers to travel distance in 1/100 mm</p>	S	1
18	Sense of rotation	i, e	i	<p><b>Counting direction of the measuring system:</b>            With shaft rotating counter-clockwise (view on the clamping ring of the actuator)            i sense of rotation (cw): ⇒ positive counting direction            e sense of rotation (ccw): ⇒ negative counting direction</p>	S	1
19	Pos Type	direct loop + loop -	direct	<p><b>Operating mode: Positioning mode:</b>            Type of positioning            direct: direct travelling from actual position to set point            loop +: travelling to the set point occurs always in positive direction to compensate for spindle play            loop -: travelling to the set point occurs always in negative direction to compensate for spindle play  <b>Notice!</b> Loop positioning in positioning mode only.  <b>Operating mode: Speed mode:</b>            irrelevant</p>	S	1

No.	Name	Selection / value	Default	Description	S	C
20	Operating mode	positioning mode / speed mode	positioning mode	<b>Operating mode: Positioning mode:</b> (see chapter 4.1.3.1: Positioning mode) <b>Operating mode: Speed mode:</b> (see chapter 4.1.3.3: Rotational speed mode)	S	1
21				reserved		
22	Node address	1 - 127	1	Setting the CAN Node-ID	S	5
23				reserved		
24	Set point	see Description column	0	<b>Operating mode: Positioning mode:</b> Indicates absolute target position. Spindle pitch = 0: Values refer to increments Spindle pitch > 0: Information refers to travel distance in 1/100 mm Value range: depends on the preprogrammed target values (parameters 15/16) <b>Operating mode: Speed mode:</b> indicates the target rotational speed in rpm Value range: Gear 66:1 ⇒ max. ±75 rpm Gear 98:1 ⇒ max. ±50 rpm Gear 188:1 ⇒ max. ±30 rpm Gear 368:1 ⇒ max. ±15 rpm	-	1
25	Stop mode Inch 2	0 - 1	0	<b>Stop mode inching mode 2 / inching key operation</b> Stopping behaviour of inching mode 2 or inching key mode, resp., can be parameterized differently. Stop mode = 0 stop with maximum deceleration Stop mode = 1 stop with programmed deceleration ( <a href="#">Parameter no. 8</a> )	S	1
26	Inpos mode	0 - 2	0	<b>Operating mode: Positioning mode:</b> With this parameter you can define the behaviour of the actuator upon reaching the position window: Inpos mode = 0 Position control to set point Inpos mode = 1 Position control OFF and short circuit of the motor windings Inpos mode = 2 Position control OFF and drive enable <b>Operating mode: Speed mode:</b> irrelevant	S	1

No.	Name	Selection / value	Default	Description	S	C
27	Loop length	0 - 30000	360	<b>Operating mode: Positioning mode:</b> Spindle pitch = 0: Values refer to increments Spindle pitch > 0: values refer to travel distance in 1/100 mm <b>Operating mode: Speed mode:</b> irrelevant	S	1
28	Contouring error limit	1 - 30000	400	<b>Contouring error limit:</b> Exceeding the contouring error limit during ongoing positioning results in a "Contouring error" fault.	S	1
29	Current limiting	25 - 110	110	<b>Current limiting:</b> Limiting of surge current. Figures indicate percentage of nominal current	S	1
30	Inching 2 Offset	10 - 100	100	<b>Inching operation 2:</b> The inching speed in Inching operation 2 can be influenced via this parameter Values in percentage of parameter no. 9.	-	1
31	Type of acceleration Inching mode 2	0 - 1	0	<b>Inching operation 2:</b> The type of acceleration can be set with this parameter. 0 = static acceleration Acceleration to final speed in one step as defined under parameter no. 8. 1 = incremental acceleration Acceleration to final speed as defined under parameter no. 8 with the following increments: 4 s to 20 % of final speed 2 s to 50 % of final speed 1 s to 100 % of final speed	S	1
32	Offset	-999999 to 999999	0	<b>Offset value</b> Changes to the offset value are immediately entered in the calculation of the position value. The following equation is applied in case of calibration: Position value = 0 + calibration value + offset value	S	1
33	Baud rate CAN	1 - 7	3	<b>Baud rate of the CAN interface:</b> 1 = 1 Mbit/s 2 = 800 kbit/s 3 = 500 kbit/s 4 = 250 kbit/s 5 = 125 kbit/s 6 = 50 kbit/s 7 = 20 kbit/s Parameter changes become active only after cold start or software reset.	S	5
34				reserved		

No.	Name	Selection / value	Default	Description	S	C
35				reserved		
36				reserved		
37	Key enable time	1 - 60	3	<b>Display / key control:</b> Time in seconds the asterisk key must be held down until menu can be entered or the set point specification is enabled via display.	S	3
38	Key function enable	0 - 1	0	<b>Display / key control:</b> The access to inching mode 2, positioning mode and rotational speed mode functions via keys can be set with this parameter. 0 = all functions via key enabled 1 = all functions via key disabled	S	3
39	LED 2 orange	0 - 1	1	<b>LED 2 orange function:</b> 0 = Off 1 = Bus operation indication	S	3
40	LED 1 red	0 - 1	1	<b>Red LED 1 function:</b> 0 = Off 1 = Indication of the operating status	S	3
41	LED 1 green	0 - 1	1	<b>Green LED 1 function:</b> 0 = Off 1 = Indication of the operating status	S	3
42	Decimal places	0 - 4	0	<b>Display:</b> Input of decimal places 0 = 0 1 = 0.0 2 = 0.00 3 = 0.000 4 = 0.0000	S	3
43	Display divisor	0 - 3	0	<b>Display:</b> Divisor by which the display accuracy is reduced compared with the measurement resolution. 0 = 1 1 = 10 2 = 100 3 = 1000	S	3
44	Direction indication function	0 - 2	0	<b>Display:</b> The direction indicators show the key to be pressed to arrive at the set position window. 0 = On 1 = Inverted 2 = Off	S	3
45	Display orientation	0 - 1	0	<b>Display:</b> Display orientation 0 = 0° 1 = rotated by 180°	S	3



No.	Name	Selection / value	Default	Description	S	C
46				reserved		
47				reserved		
48	PIN Change	0 - 99999	0	<b>Display:</b> Required PIN to be able to change parameters via keys and display.	S	3
49	Displayed value 2 <sup>nd</sup> display line	0 - 8	0	<b>Display:</b> Parameter to be displayed in the 2 <sup>nd</sup> line of the display. 0 = Set point 1 = Output stage temperature 2 = Control voltage 3 = Output stage voltage 4 = Battery voltage 5 = Motor current 6 = Actual position 7 = Actual rotational speed 8 = Motor thermal load	S	3
50	Output stage temperature	Read only	-	<b>Output stage temperature:</b> Values in 1/10 °C	-	-
51	Voltage of control	Read only	-	<b>Control voltage:</b> Values in 1/10 V	-	-
52	Voltage of output stage	Read only	-	<b>Output stage voltage:</b> Values in 1/10 V	-	-
53	Voltage of battery	Read only	-	<b>Battery voltage:</b> Values in 1/100 V	-	-
54	Motor current	Read only	-	<b>Motor current:</b> Values in mA	-	-
55	Actual position	Read only	-	<b>Actual position:</b> Spindle pitch = 0: values in increments Spindle pitch > 0: values in 1/100 mm	-	-
56	Actual rotational speed	Read only	-	<b>Actual rotational speed:</b> Values in rpm	-	-
57	Serial number	Read only	-	<b>Serial number</b>	S	-
58	Production date	Read only	-	<b>Production date:</b> Format: DDMMJJJJ	S	-
59	Software version motor controller	Read only	-	<b>Motor controller software version</b>	S	-

No.	Name	Selection / value	Default	Description	S	C
60	Software version display controller	Read only	-	<b>Display controller software version</b>	S	-
61	Number of errors	Read only	-	<b>Number of errors in the error memory</b>	S	-
62	Error 1	Read only	-	<b>Error 1</b>	S	-
63	Error 2	Read only	-	<b>Error 2</b>	S	-
64	Error 3	Read only	-	<b>Error 3</b>	S	-
65	Error 4	Read only	-	<b>Error 4</b>	S	-
66	Error 5	Read only	-	<b>Error 5</b>	S	-
67	Error 6	Read only	-	<b>Error 6</b>	S	-
68	Error 7	Read only	-	<b>Error 7</b>	S	-
69	Error 8	Read only	-	<b>Error 8</b>	S	-
70	Error 9	Read only	-	<b>Error 9</b>	S	-
71	Error 10	Read only	-	<b>Error 10</b>	S	-
72	Gear reduction	Read only	-	<b>Gear reduction</b>	S	-
73	System Status Word	Read only	-	<b>System status word</b>	-	-
74	Display divisor application	0 - 1	0	<b>Positioning mode only:</b> 0 = The display divisor is applied to the interface's target and actual positions and to the display. 1 = The display divisor is applied to the display only.	S	3
75	Motor thermal load	Read only	-	<b>Motor thermal load:</b> Specified in (motor thermal load / max. motor thermal load) [%].	-	-
76	Fault counter 1	Read only	-	<b>Fault counter 1:</b> Timeout Client	-	-
77	Fault counter 2	Read only	-	<b>Fault counter 2:</b> Timeout Host	-	-
78	Fault counter 3	Read only	-	<b>Fault counter 3:</b> Checksumme Client	-	-
79	Fault counter 4	Read only	-	<b>Fault counter 4:</b> Checksumme Host	-	-
80	Fault counter 5	Read only	-	<b>Fault counter 5:</b> Define Mismatch	-	-
81	Fault counter 6	Read only	-	<b>Fault counter 6:</b> Battery undervoltage	-	-
82	Fault counter 7	Read only	-	<b>Fault counter 7:</b> Control electronics undervoltage	-	-

No.	Name	Selection / value	Default	Description	S	C
83	Fault counter 8	Read only	-	<b>Fault counter 8:</b> Control electronics overvoltage	-	-
84	Fault counter 9	Read only	-	<b>Fault counter 9:</b> Power electronics overvoltage	-	-
85	Fault counter 10	Read only	-	<b>Fault counter 10:</b> Power stage overtemperature	-	-
86	Fault counter 11	Read only	-	<b>Fault counter 11:</b> Tracking error	-	-
87	Fault counter 12	Read only	-	<b>Fault counter 12:</b> Shaft blocked	-	-
88	Fault counter 13	Read only	-	<b>Fault counter 13:</b> Error SinCos monitoring	-	-
89	Fault counter 14	Read only	-	<b>Fault counter 14:</b> Queue 1 Overflow	-	-
90	Fault counter 15	Read only	-	<b>Fault counter 15:</b> Queue 2 Overflow	-	-
91	Fault counter 16	Read only	-	<b>Fault counter 16:</b> Checksumme EEPROM	-	-
92	Fault counter 17	Read only	-	<b>Fault counter 17:</b> Error Passive state	-	-
93	Fault counter 18	Read only	-	<b>Fault counter 18:</b> Bus Off state	-	-
94	Fault counter 19	Read only	-	<b>Fault counter 19:</b> Queue 3 Overflow	-	-
95	Fault counter 20	Read only	-	<b>Fault counter 20:</b> Queue 4 Overflow	-	-
96	Fault counter 21	Read only	-	<b>Fault counter 21:</b> CAN Overflow	-	-
97	Fault counter 22	Read only	-	<b>Fault counter 22:</b> Motor overcurrent	-	-
98	Fault counter 23	Read only	-	<b>Fault counter 23:</b> Position control unstable	-	-
99	Fault counter 24	Read only	-	<b>Fault counter 24:</b> Thermal overload motor	-	-

Table 13: Parameter description

## 9 Communication via CAN bus

### 9.1 General remarks

This chapter describes activation and parameterization via CAN bus interface.

For the connector pin assignment of the CAN bus interface please refer to the installation instructions.

### 9.1.1 Interface

The following baud rates are supported:

1 Mbit/s, 800 kbit/s, 500 kbit/s, 250 kbit/s, 125 kbit/s, 50 kbit/s, 20 kbit/s

#### Termination of the CAN bus line:

If the actuator is at the end of the bus, the CAN bus connection must be terminated by a defined bus terminator.

## 9.2 System Status Word

The system status word consists of 2 bytes and reflects the state of the actuator (see chapter 8: [Parameter description](#) ⇒ [Parameter no. 73](#)).

High Byte								Low Byte							
Bit number															
15	14	13	12	11	10	9	8	7	6	5	4	3	2	1	0
0	0	1	0	1	0	0	1	0	1	0	0	1	0	0	0
2				9				4				8			

Table 14: Structure of system status word

Example (grey background):

binary: ⇒ 0010 1001 0100 1000

hex: ⇒ 2 9 4 8

### 9.2.1 Meaning of the bits

The table below informs about the meaning of the individual bits of the status word:

Bit	State	Description
Bit 0	'0'	irrelevant
Bit 1	'0'	irrelevant
Bit 2	'0'	irrelevant
Bit 3		<b>Operating mode: Positioning mode In Position</b>
	'1'	Actual position is within the positioning window of the programmed set point.
	'0'	Actual position is beyond the positioning window of the programmed set point.
		<b>Operating mode: Speed mode: In Position</b>
	'1'	Actual rotational speed is within the specified tolerance window of the target speed.
	'0'	Actual speed is outside the specified tolerance window.
Bit 4		<b>Actuator travels:</b>

Bit	State	Description
	'1'	Actuator travels.
	'0'	Drive stands still (rotational speed <2 rpm).
Bit 5		<b>Operating mode: Positioning mode, upper limit</b>
	'1'	Actual position is above the programmed limiting value. Travelling is possible only in negative direction in inching mode.
	'0'	Actual position is below the programmed limiting value.
	'0'	<b>Operating mode: Speed mode: irrelevant</b>
Bit 6		<b>Operating mode: Positioning mode, lower limit</b>
	'1'	Actual position is below the programmed limiting value. Travelling is possible only in positive direction in inching mode.
	'0'	Actual position is above the programmed limiting value.
	'0'	<b>Operating mode: Speed mode: irrelevant</b>
Bit 7		<b>Driver state:</b>
	'1'	Motor is enabled.
	'0'	Motor in control.
Bit 8		<b>Error:</b>
	'1'	Actuator has switched to error. The cause of the error must be removed and acknowledged.
	'0'	No error present.
Bit 9		<b>Operating mode: Positioning mode: Loop travel</b>
	'1'	If travel direction unequal start direction (with loop travel).
	'0'	If travel direction equal start direction.
	'0'	<b>Operating mode: Speed mode: irrelevant</b>
Bit 10		<b>Output stage supply voltage:</b>
	'1'	No voltage, no travelling possible.
	'0'	Voltage applied.
Bit 11		<b>Ready for travel:</b>
	'1'	Not ready for travel
	'0'	Ready for travel: - Actuator not in error state - No active positioning - Supply voltage of the output stage is applied - Actual position within limits (only positioning mode)
Bit 12		<b>Battery voltage:</b>
	'1'	Battery voltage <2.6 V
	'0'	Battery voltage o. k.
Bit 13		<b>Current limiting:</b>
	'1'	Current limiting active.
	'0'	Current limiting not active.
Bit 14		<b>Operating mode: Positioning mode Status</b>
	'1'	Positioning active in positioning mode.
	'0'	Positioning inactive.
		<b>Operating mode: Speed mode: Status</b>

Bit	State	Description
	'1'	Enable target speed.
	'0'	Target speed disabled.
Bit 15		<b>Contouring error:</b>
	'1'	Contouring error $\Rightarrow$ the actuator cannot reach the pre-set speed due to too high load. The actuator switches the contouring error fault. Remedy: reduce programmed speed!
	'0'	No contouring error $\Rightarrow$ actual speed corresponds to target speed.

Table 15: System Status Word

### 9.3 CANopen protocol

The CANopen protocol is based on the CANopen communication profile CiA DS-301 V4.0 as well as the device profile Drives and Motion Control CiA DSP-402 V2.0.

The details required for a better understanding and possible deviations are included in this documentation.

#### 9.3.1 Telegram setup

The data telegram of a CAN message consists of the following fields:

##### SOF:

Start of Frame  $\Rightarrow$  start bit of the telegram

##### Identifier:

The Identifier field contains the identifier as well as bits for the recognition of the length of the identifiers (11 or 29 bits). The identifier determines the priority of the message. Via identifier, CANopen determines additionally the device address, channel selection as well as data direction.

##### Control field:

Contains bits concerning the number of user data and determines whether a data frame or RTR frame (Remote Transfer Request frame) is concerned.

##### Data field:

Contains up to 8 bytes of user data. The user data has a different meaning depending on the channel selection.

##### CRC:

Contains bits for error detection.

##### ACK/EOF:

The ACK/EOF field contains telegram acknowledgement bits as well as bits for determining the end of telegram.



Fig. 8: Telegram setup

For a detailed description of the telegram please refer to the comprehensive CAN literature.

For simplification, only identifier and data field will be dealt with in the subsequent telegram descriptions.

### 9.3.2 Network management (NMT)

The master configures, manages and monitors network nodes via the NMT service.

For switching between the four available communication states of a network node, 'INITIALISATION', 'PRE-OPERATIONAL', 'OPERATIONAL' and 'STOPPED', telegrams with the identifier '0' as well as 2 bytes of user data are used. The identifier of the NMT protocol is limited to 11 bits.

#### 9.3.2.1 State Diagramm

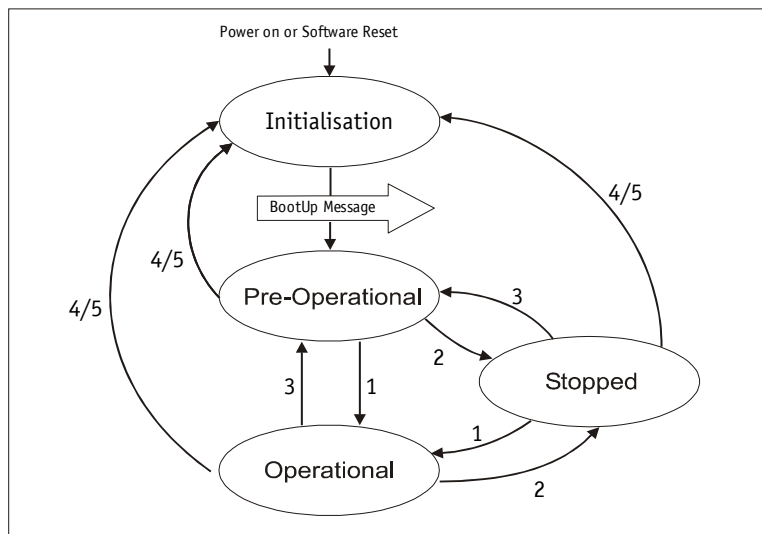

Fig. 9: State Diagramm

#### 9.3.2.2 NMT Status 'INITIALISATION'

The actuator is not involved in the bus actions in this state. All hardware and software components are initialised. This state is attained after switching on the device or after receipt of the command code 82<sub>h</sub> of the own or global addresses. After completion of initialisation, the actuator goes automatically into the 'PRE-OPERATIONAL' status. This is signalled by a boot-up message consisting of the identifier '1791 + Node ID' and a data byte having the value '0'.

### 9.3.2.3 NMT Status 'PRE-OPERATIONAL'

The exchange of parameterization data (SDOs) between the actuator and the bus master is enabled. However, no process data (PDOs) is transferred. Furthermore, the State Machine of the actuator is set to the 'SWITCH ON DISABLED' state (see chapter 9.4: [State Machine](#)) and the motor enabled.

**NOTICE**

PDO parameters can be changed in this state only!

### 9.3.2.4 NMT Status 'OPERATIONAL'

Exchange of process and parameterization data is enabled.

Hint: TPDOs with the 254 transfer type are sent with the transition into the 'OPERATIONAL' NMT status.

### 9.3.2.5 NMT Status 'STOPPED'

Exchange of all data is stopped with the exception of the heartbeat message (see chapter 9.3.10: [Heartbeat protocol](#)) and the node guarding protocol, if active (see chapter 9.3.11: [Node Guarding](#)). Only NMT communication is enabled. Furthermore, the State Machine of the actuator is set to the 'SWITCH ON DISABLED' state (see chapter 9.4: [State Machine](#)) and the motor enabled.

### 9.3.2.6 Switching between communication states

The network master can switch between the communication states by sending the following telegrams with the identifier '0'.

Status change		Data 1	Data 2
from	to		
PRE-OPERATIONAL / STOPPED	OPERATIONAL (1)	01h	xx
OPERATIONAL / PRE-OPERATIONAL	STOPPED (2)	02h	xx
OPERATIONAL / STOPPED	PRE-OPERATIONAL (3)	80h	xx
OPERATIONAL / PRE-OPERATIONAL / STOPPED	INITIALISATION (4/5)	81h	xx
OPERATIONAL / PRE-OPERATIONAL / STOPPED	INITIALISATION * (4/5)	82h	xx

Table 16: Switching between communication state

\* Cold start is triggered (Power on)

xx = 0 ⇒ the telegram is intended for all devices on the bus

xx = device address ⇒ the telegram is only intended for the device with the respective address.



### 9.3.3 SYNC-Objekt

CANopen enables the simultaneous query of all inputs and the simultaneous setting of all outputs. The synchronization telegram (SYNC), a CAN message with high priority, which contains no user data serves for this purpose.

The identifier of the Sync object can be set via object 1005<sub>h</sub> (see chapter 9.13.2: [Description of objects](#)).

### 9.3.4 Process Data Objects (PDOs)

Process data objects serve for fast exchange of short process data. Process data objects are transferred event-triggered, cyclically or on request. A maximum of 8 bytes of user data can be transferred in a PDO.

**NOTICE** The exchange of PDOs is enabled in the NMT status Operational only!

The actuator provides 3 Transmit PDOs (process data from the actuator ⇒ NMT master) and 3 Receive PDOs (process data from the NMT master ⇒ to the actuator). The Receive PDOs, RPDO1, RPDO3, RPDO4 and the Transmit PDOs, TPDO1, TPDO3 and TPDO4 are supported according to the Device Profil 'Drives and Motion Control CIA DSP-402 Version 2.0'.

### 9.3.5 Transmit-PDOs

#### 9.3.5.1 1<sup>st</sup> Transmit PDO (TPDO1)

The first Transmit PDO contains 2 user data bytes on which the status word of the actuator is mapped.

The Transmit PDO is transferred by the actuator asynchronously as a standard. Together with the Receive PDO1 on which the control word of the state machine is mapped it forms a handshake connection (acknowledgement operation) between the higher-order control and the drive controller.

It is, therefore not recommended to change the transfer type of the TDO1.

The COB-ID of the first Transmit PDO is programmed to 180<sub>h</sub> + Node-ID by default. The communication parameters are set via the object 1800<sub>h</sub> (1<sup>st</sup> Transmit PDO parameter).

1 <sup>st</sup> Transmit PDO		
11/29 Bit Identifier	Byte 1	Byte 2
	LSB	MSB
Status word (object 6041 <sub>h</sub> )		

Table 17: 1<sup>st</sup> Transmit PDO

#### 9.3.5.2 3<sup>rd</sup> Transmit PDO (TPDO3)

The third Transmit PDO contains 6 user data bytes on which the status word and the current position value of the actuator are mapped.

The Transmit PDO3 is transferred only by a RTR frame (remote transfer request) as a standard, i. e., a higher-order control must request the TDO3 (polling). Synchronous transfer (value 0 to 240) can be set via the SYNC object or the time-triggered transfer (value 255) by means of a local cycle (event timer) as an alternative to polling.

The COB-ID of the third Transmit PDO is programmed to  $380_h + \text{Node-ID}$  by default. The communication parameters are set via the object  $1802_h$  (3<sup>rd</sup> Transmit PDO parameter).

3 <sup>rd</sup> Transmit PDO						
11/29 Bit Identifier	Byte 1	Byte 2	Byte 3	Byte 4	Byte 5	Byte 6
	LSB	MSB	LSB	NSB	NSB	MSB
	Status word (object $6041_h$ )		Position value (object $6064_h$ )			

Table 18: 3<sup>rd</sup> Transmit PDO

### 9.3.5.3 4<sup>th</sup> Transmit PDO (TPD04)

The fourth Transmit PDO contains 6 user data bytes on which the status word and the actual velocity of the actuator is mapped. The Transmit PDO4 is transferred only by a RTR frame (remote transfer request) as a standard, i. e., a higher-order control must request the TDO4 (polling). Synchronous transfer (value 0 to 240) can be set via the SYNC object or the time-triggered transfer (value 255) by means of a local cycle (event timer) as an alternative to polling.

The COB-ID of the fourth Transmit PDO is programmed to  $480_h + \text{Node-ID}$  by default. The communication parameters are set via the object  $1803_h$  (4<sup>th</sup> Transmit PDO parameter).

4 <sup>th</sup> Transmit PDO						
11/29 Bit Identifier	Byte 1	Byte 2	Byte 3	Byte 4	Byte 5	Byte 6
	LSB	MSB	LSB	NSB	NSB	MSB
	Status word (object $6041_h$ )		Actual velocity (object $606C_h$ )			

Table 19: 4<sup>th</sup> Transmit PDO

### 9.3.5.4 Transfer types of the Transmit PDOs

Different transfer types can be set for the individual PDOs via objects  $1800_h$  until  $1803_h$  'Transmit PDO Parameter' sub-index 2 (see chapter 9.13.2: [Description of objects](#)).

#### Synchronous:

Sub-index 2 (transfer type) = 0:

The Transmit PDO is sent by the actuator upon receipt of each SYNC telegram.

Sub-index 2 (transfer type) = 1 ... 240:

The Transmit PDO is sent by the actuator only after receipt of the number of SYNC telegrams indicated under 'transfer type'.

#### Asynchronous:

Event-Triggered: Sub-index 2 (transfer type) = 254

A PDO is transmitted with every change of a mapped object and in a time-controlled way. The Event Timer can be deactivated.

Time-Triggered: Sub-index 2 (transfer type) = 255

The PDOs are transferred time-triggered.

The sub-index 5 'Event Timer' of the Transmit PDO parameters indicates the cycle time in milliseconds.

Sub-index 2 (transfer type) = 253

The Transmit PDO is sent after receipt of a RTR frame with the identifier of the respective Transmit PDO.

### 9.3.6 Receive-PDOs

#### 9.3.6.1 1<sup>st</sup> Receive PDO (RPDO1)

The first Receive PDO contains 2 user data bytes on which the status word of the actuator is mapped.

The control word in the Receive PDO1 serves for controlling the operation transitions of the state machine. The Receive PDO1 serves for getting the state machine into the OPERATION ENABLED state or for commanding travel interruption or cancellation of travel during running drive movement, respectively.

The drive controller processes the Receive PDO1 asynchronously as a standard. Together with the Transmit PDO1 on which the control word of the state machine is mapped it forms a handshake connection (acknowledgement operation) between the higher-order control and the drive controller.

It is, therefore not recommended to change the transfer type of the RPDO1.

The COB-ID of the first Receive PDO is programmed to  $200_h + \text{Node-ID}$  by default. The communication parameters are set via the object  $1400_h$  (1<sup>st</sup> Receive PDO parameter).

1 <sup>st</sup> Receive PDO		
11/29 Bit Identifier	Byte 1	Byte 2
	LSB	MSB
	Control word (object $6040_h$ )	

Table 20: 1<sup>st</sup> Receive PDO

#### 9.3.6.2 3<sup>rd</sup> Receive PDO (RPDO3)

The third Receive PDO is assigned to the operation mode 'Profile Position Mode' (positioning mode) and contains 6 user data bytes on which the control word as well as the current target value for the actuator is mapped.

The position transferred is taken over as the absolute target position. Drive movement in the positioning mode can be executed from the 'OPERATION ENABLED' state of the state machine only.

The drive controller processes the Receive PDO3 asynchronously as a standard. Together with the Transmit PDO1 on which the status word of the state machine is mapped, it forms a

handshake connection (acknowledgement operation) between the higher-order control and the drive controller.

Synchronous transfer type (value 0) can be set to enable synchronous start of more than one drive. The data of the RPDO3 is processed only after receipt of the next SYNC telegram in this case (see chapter 9.3.3: [SYNC-Objekt](#)).

The COB-ID of the third Transmit PDO is programmed to  $400_h + \text{Node-ID}$  by default. The communication parameters are set via the object  $1402_h$  (3<sup>rd</sup> Receive PDO parameter).

3 <sup>rd</sup> Receive PDO						
11/29 Bit Identifier	Byte 1	Byte 2	Byte 3	Byte 4	Byte 5	Byte 6
	LSB	MSB	LSB	NSB	NSB	MSB
	Control word (object $6040_h$ )		Target value (object $607A_h$ )			

Table 21: 3<sup>rd</sup> Receive PDO

### 9.3.6.3 4<sup>th</sup> Receive PDO (RPDO4)

The fourth Receive PDO is assigned to the operation mode 'Velocity Mode' and contains 6 user data bytes on which the control word as well as the current target velocity for the actuator are mapped.

A driving movement in positive or negative sense of rotation is started via the control word in the Receive PDO4. Drive movement in the velocity mode can be executed from the 'OPERATION ENABLED' state of the state machine only.

The drive controller processes the Receive PDO4 asynchronously as a standard. Together with the Transmit PDO1 onto which the status word of the state machine is mapped, it forms a handshake connection (acknowledgement operation) between the higher-order control and the drive controller.

Synchronous transfer type (value 0) can be set to enable synchronous start of more than one drive. The data of the RPDO4 is processed only after receipt of the next SYNC telegram in this case (see chapter 9.3.3: [SYNC-Objekt](#)).

The COB-ID of the fourth Transmit PDO is programmed to  $500_h + \text{Node-ID}$  by default. The communication parameters are set via the object  $1403_h$  (4<sup>th</sup> Receive PDO parameter).

4 <sup>th</sup> Receive PDO						
11/29 Bit Identifier	Byte 1	Byte 2	Byte 3	Byte 4	Byte 5	Byte 6
	LSB	MSB	LSB	NSB	NSB	MSB
	Control word (object $6040_h$ )		Target velocity (object $60FF_h$ )			

Table 22: 4<sup>th</sup> Receive PDO

### 9.3.6.4 Transfer types of the Receive PDOs

Different transfer types can be set for the individual PDOs via objects  $1400_h$  until  $1403_h$  'Receive PDO Parameter' sub-index 2 (see chapter 9.13.2: [Description of objects](#)).

**Synchronous:**

Sub-index 2 (transfer type) = 0 ... 240

In the synchronous transfer type, the Receive PDOs are processed only after receipt of a SYNC telegram.

**Asynchronous:**

Sub-index 2 (transfer type) = 254 ... 255

In the asynchronous transfer type, the Receive PDOs are processed by the actuator immediately after receipt of the Receive PDO.

**9.3.7 Service Data Objects (SDOs)**

Service Data Objects (SDOs) serve in the first place for transferring device configuration parameters.

8 bytes of user data are always transferred in a SDO. The identifier is set to 11 bits and cannot be changed.

<b>NOTICE</b>	The exchange of SDOs is enabled in the NMT statuses "Pre-Operational" as well as "Operational"!
---------------	---

There is each one COB ID for data transfer from the master to the actuator (COB-ID  $600_h + \text{Node-ID}$ ) and one COB ID for data transfer from the actuator to the master (COB-ID  $580_h + \text{Node-ID}$ ).

Data transfer is always initiated and controlled by the master.

The COB IDs for the Service Data Objects cannot be changed.

SDO Telegram								
11 Bit Identifier	Byte 1	Byte 2	Byte 3	Byte 4	Byte 5	Byte 6	Byte 7	Byte 8
	Command	Parameter index	Sub-index	Data 1	Data 2	Data 3	Data 4	

Table 23: Setup of the SDO telegram

**Byte 1: Command code**

The first byte contains the command code of the SDO telegram. The following table lists the available commands and describes their meaning.

Command	Command code hexadecimal	Command code decimal	Meaning
Write Request	23 <sub>h</sub>	35	send parameters (4 data byte)
Write Request	2B <sub>h</sub>	43	send parameters (2 data byte)
Write Request	2F <sub>h</sub>	47	send parameters (1 data byte)
Write Response	60 <sub>h</sub>	96	response of Write Request
Read Request	40 <sub>h</sub>	64	request of a parameter
Read Response	43 <sub>h</sub>	67	response to the request (4 data byte)
Read Response	4B <sub>h</sub>	75	response to the request (2 data byte)
Read Response	4F <sub>h</sub>	79	response to the request (1 data byte)
Error Response	80 <sub>h</sub>	128	error message

Table 24: Command codes

**Bytes 2/3: Parameter index**

The parameter index is entered in the user data byte 2 (low byte) and in the user data byte 3 (high byte) using their Intel data format.

Here, the index of the object to be parameterized is entered (see chapter 9.13.2: [Description of objects](#)).

**Byte 4: Sub-index**

The sub-index indicates the number of the fields for objects realized as an array.

**Bytes 5 ... 8: Data area**

In the data area, the value of the parameter is entered in left-aligned Intel notation.

Byte 5 = low-Byte ... Byte 8 = high Byte

**9.3.7.1 Error code**

The actuator sends an error response (byte 1 = 80<sub>h</sub>) if a communication error has occurred. An error code is entered in the user data bytes (bytes 5 ... 8). The table below shows the supported error codes.

Command code	Data 1	Data 2	Data 3	Data 4	Meaning
80 <sub>h</sub>	11 <sub>h</sub>	00 <sub>h</sub>	09 <sub>h</sub>	06 <sub>h</sub>	Sub-Index not exist.
80 <sub>h</sub>	02 <sub>h</sub>	00 <sub>h</sub>	01 <sub>h</sub>	06 <sub>h</sub>	Attempt to write read only object.
80 <sub>h</sub>	01 <sub>h</sub>	00 <sub>h</sub>	01 <sub>h</sub>	06 <sub>h</sub>	Attempt to read write only object.
80 <sub>h</sub>	30 <sub>h</sub>	00 <sub>h</sub>	09 <sub>h</sub>	06 <sub>h</sub>	Value range of parameter exceeded.
80 <sub>h</sub>	36 <sub>h</sub>	00 <sub>h</sub>	09 <sub>h</sub>	06 <sub>h</sub>	Maximum value is less than minimum value.
80 <sub>h</sub>	00 <sub>h</sub>	00 <sub>h</sub>	02 <sub>h</sub>	06 <sub>h</sub>	Object does not exist.
80 <sub>h</sub>	00 <sub>h</sub>	00 <sub>h</sub>	01 <sub>h</sub>	06 <sub>h</sub>	Unsupported access to an object.
80 <sub>h</sub>	22 <sub>h</sub>	00 <sub>h</sub>	00 <sub>h</sub>	08 <sub>h</sub>	Data cannot be transferred to the application because of the present device state.

Table 25: Error codes

**9.3.8 Example: Parameterization**

The following 2 examples are intended to illustrate parameterization via Service Data Objects.

**9.3.8.1 Example: Read parameter**

The actuator has device address 5 and the calibration value is to be read out!

Calculation of the identifier:

Identifier of the parameter channel to the actuator =  $600_h + \text{device address}$

$$600_h = 1536_{\text{dec}}$$

$$\text{Identifier} = 1536 + 5 = 1541 = 605_h$$

Command code = Read request (= request of a parameter from the actuator) =  $40_h$

$$\text{Index} = 607C_h$$

The index of the parameter calibration value was taken from the directory of objects (chapter [9.13.2: Description of objects](#)).

Sub-index = 0

The current calibration value is  $2500 = 9C4_h$ .

Telegram from the master to the actuator:

Identifier	Byte 1	Byte 2	Byte 3	Byte 4	Byte 5	Byte 6	Byte 7	Byte 8
$605_h$	$40_h$	$7C_h$	$60_h$	$00_h$	$00_h$	$00_h$	$00_h$	$00_h$

Response of the actuator:

Identifier	Byte 1	Byte 2	Byte 3	Byte 4	Byte 5	Byte 6	Byte 7	Byte 8
$585_h$	$42_h$	$7C_h$	$60_h$	$00_h$	$C4_h$	$09_h$	$00_h$	$00_h$

Command code = Read Response =  $42_h$

Calculation of the identifier:

Identifier of the parameter channel from the actuator to the master =  $580_h + \text{device address}$

$$580_h = 1408_{\text{dec}}$$

$$\text{Identifier} = 1408 + 5 = 1413 = 585_h$$

### 9.3.8.2 Example: Write parameter

For the actuator with device address 5 the limit 1 is to be set to 2000000!

Calculation of the identifier:

Identifier of the parameter channel to the actuator =  $600_h + \text{device address}$

$$600_h = 1536_{\text{dec}}$$

$$\text{Identifier} = 1536 + 5 = 1541 = 605_h$$

Command code = Write request (send parameter to the actuator) =  $23_h$

$$\text{Index} = 607D_h$$

Sub-index = 2

The index and the sub-index of the parameter 'limit 1' were taken from the directory of objects (chapter [9.13.2: Description of objects](#)).

$$2000000 = 1E8480_h$$

Telegram from the master to the actuator:

Identifier	Byte 1	Byte 2	Byte 3	Byte 4	Byte 5	Byte 6	Byte 7	Byte 8
$605_h$	$23_h$	$7D_h$	$60_h$	$02_h$	$80_h$	$84_h$	$1E_h$	$00_h$

Response of the actuator in the case of error-free execution:

Identifier	Byte 1	Byte 2	Byte 3	Byte 4	Byte 5	Byte 6	Byte 7	Byte 8
585 <sub>h</sub>	60 <sub>h</sub>	7D <sub>h</sub>	60 <sub>h</sub>	02 <sub>h</sub>	00 <sub>h</sub>	00 <sub>h</sub>	00 <sub>h</sub>	00 <sub>h</sub>

Command code = Write Response = 60<sub>h</sub>

Calculation of the identifier:

Identifier of the parameter channel from the actuator to the master = 580<sub>h</sub> + device address

580<sub>h</sub> = 1408<sub>dec</sub>

Identifier = 1408 + 5 = 1413 = 585<sub>h</sub>

### 9.3.9 Emergency Object (EMCY)

In the case of an error, the node status is transferred via high-priority emergency messages (emergency telegrams). These telegrams have a data length of 8 bytes and contain error information.

The emergency telegram is transferred as soon as the actuator goes into the fault state (for the causes of faults refer to chapter 7.2: Errors) or when a communication error has occurred (see Table 27: Error-Code 8110<sub>h</sub> – 8140<sub>h</sub>).

Resolution of the cause of fault and resetting of the actuator with undoing the fault state are signalled by sending of an emergency telegram with the error code 0000<sub>h</sub> (no error) (not applicable to error code 8140<sub>h</sub>).

The cause of the fault is deposited in the fault buffer (see object 1003<sub>h</sub>).

Setup of the emergency telegram.

Identifier	Byte 0	Byte 1	Byte 2	Byte 3	Byte 4	Byte 5	Byte 6	Byte 7
11/29 Bit	Emergency Error Code (see chapter 9.3.9)	Error Register (Object 1001 <sub>h</sub> )	Manufacturer-specific error field (not used)					

Table 26: Emergency protocol

The identifier of the emergency object is set to 128 + Node-ID by default; however, it can be changed via object 1014<sub>h</sub> (see chapter 9.13.2: Description of objects). Transfer of an emergency telegram is enabled in the NMT statuses 'OPERATIONAL' or 'PRE-OPERATIONAL' only!

#### 9.3.9.1 Error Code

The following table contains the possible error codes of the emergency telegram.

Error Code		Meaning
Byte 0 (Highbyte)	Byte 1 (Lowbyte)	
00	00 <sub>h</sub>	No error (no fault present) Is sent after clearing the fault state (see chapter 7.2: Errors).
32	11 <sub>h</sub>	Control Overvoltage The state machine was set to the 'Fault' state. Fault is deposited in the fault buffer.



Error Code		Meaning
Byte 0 (Highbyte)	Byte 1 (Lowbyte)	
32	12 <sub>h</sub>	Power Overvoltage The state machine was set to the 'Fault' state. Fault is deposited in the fault buffer.
32	21 <sub>h</sub>	Control Undervoltage The state machine was set to the 'Fault' state. Fault is deposited in the fault buffer.
32	22 <sub>h</sub>	Power Undervoltage The state machine was set to the 'Fault' state. Fault is deposited in the fault buffer.
43	10 <sub>h</sub>	Overtemperature The state machine was set to the 'Fault' state. Fault is deposited in the fault buffer.
71	21 <sub>h</sub>	Motor blocked The state machine was set to the 'Fault' state. Fault is deposited in the fault buffer.
73	00 <sub>h</sub>	Sensor SIN/COS monitoring The state machine was set to the 'Fault' state. Fault is deposited in the fault buffer.
81	10 <sub>h</sub>	CAN overrun The state machine was set to the 'Fault' state. Fault is deposited in the fault buffer.
81	20 <sub>h</sub>	Error Passive
81	40 <sub>h</sub>	Recovered from Bus Off
86	11 <sub>h</sub>	Contouring Error The state machine was set to the 'Fault' state. Fault is deposited in the fault buffer.
FF	02 <sub>h</sub>	Manufacturer specific Error Passive on Move The state machine was set to the 'Fault' state. Fault is deposited in the fault buffer.
FF	03 <sub>h</sub>	Manufacturer specific Bus Off
FF	04 <sub>h</sub>	Manufacturer specific Timeout Client The state machine was set to the 'Fault' state. Fault is deposited in the fault buffer.
FF	05 <sub>h</sub>	Manufacturer specific Timeout Host The state machine was set to the 'Fault' state. Fault is deposited in the fault buffer.
FF	06 <sub>h</sub>	Manufacturer specific Checksum Client The state machine was set to the 'Fault' state. Fault is deposited in the fault buffer.

Error Code		Meaning
Byte 0 (Highbyte)	Byte 1 (Lowbyte)	
FF	07 <sub>h</sub>	Manufacturer specific Checksum Host The state machine was set to the 'Fault' state. Fault is deposited in the fault buffer.
FF	08 <sub>h</sub>	Manufacturer specific Define Mismatch The state machine was set to the 'Fault' state. Fault is deposited in the fault buffer.
FF	09 <sub>h</sub>	Manufacturer specific Battery Undervoltage The state machine was set to the 'Fault' state. Fault is deposited in the fault buffer.
FF	0A <sub>h</sub>	Manufacturer specific Unknown Bustype The state machine was set to the 'Fault' state. Fault is deposited in the fault buffer.
FF	0B <sub>h</sub>	Manufacturer specific Queue 1 overrun The state machine was set to the 'Fault' state. Fault is deposited in the fault buffer.
FF	0C <sub>h</sub>	Manufacturer specific Queue 2 overrun The state machine was set to the 'Fault' state. Fault is deposited in the fault buffer.
FF	0D <sub>h</sub>	Manufacturer specific Question Answer The state machine was set to the 'Fault' state. Fault is deposited in the fault buffer.
FF	0E <sub>h</sub>	Manufacturer specific Checksum EEPROM The state machine was set to the 'Fault' state. Fault is deposited in the fault buffer.
FF	0F <sub>h</sub>	Manufacturer specific Queue 3 Overrun The state machine was set to the 'Fault' state. Fault is deposited in the fault buffer.
FF	10 <sub>h</sub>	Manufacturer specific Queue 4 Overrun The state machine was set to the 'Fault' state. Fault is deposited in the fault buffer.
FF	11 <sub>h</sub>	Motor overcurrent
FF	12 <sub>h</sub>	Position control unstable (see chapter 4.4.2)
FF	13 <sub>h</sub>	Motor thermal overload (see chapter 4.4.1)

Table 27: Error Code

### 9.3.10 Heartbeat protocol

The master monitors the state of the actuator via heartbeat protocol. While doing this, the actuator sends cyclically its NMT status.

The actuator sends the heartbeat telegram independently, without request via RTR frame. The actuator is a heartbeat producer, it does not receive nor process heartbeat protocols.

The cycle time of the heartbeat telegram is set via object 1017<sub>h</sub> (see chapter 9.13.2: [Description of objects](#)).

The heartbeat protocol is deactivated if the cycle time is 0.

The heartbeat protocol consists of one byte.

Identifier	Byte 1
11 Bit	Status

Table 28: Heartbeat protocol

Status = 0: 'INITIALISATION'

Status = 4: 'STOPPED'

Status = 5: 'OPERATIONAL'

Status = 127: 'PRE-OPERATIONAL'

The identifier of the heartbeat protocol is permanently set to 1792 + Node-ID and cannot be changed.

Heartbeat telegram is sent in the NMT statuses 'OPERATIONAL', 'PRE-OPERATIONAL' or 'STOPPED'.

<b>NOTICE</b>	The heartbeat protocol is only enabled when node guarding is deactivated!
---------------	---

### 9.3.11 Node Guarding

Node-guarding or life-guarding mechanisms are available for failure monitoring of the CANopen network. Via node guarding the nodes are monitored that can detect a failure of the master. During guarding, the master transmits remote frames (remot transmit request, message request telegrams) on the guarding identifiers of the nodes to be monitored. The latter respond with the guarding message containing the current status of the slave as well as a toggle bit which must change after each message.

The master assumes that a node error as occurred if status or toggle bits do not correspond with those expected by the master.

Via the objects 100C<sub>h</sub> (Guard Time), 100D<sub>h</sub> (Life Time Factor) the time interval (life time) is set within which the actuator expects a node query (RTR frame with the COB-ID 1792 + Node-ID) by the NMT master.

The time interval 'Life time' is calculated from the cycle time 'Guard time' multiplied with the factor 'Life Time Factor'.

The actuator State Machine switches to the 'SWITCH ON DISABLED' state if the actuator receives no RTR frame from the master during the 'Life Time'.

By sending the first RTR frame of the master to the actuator, Node Guarding of the actuator is activated after switching on.

Node Guarding is deactivated if the value of either object (100C<sub>h</sub> / 100D<sub>h</sub>) is zero.

The response of the actuator to the RTR frame of the master consists of one byte of user data.

Identifier	Byte 1	
11 Bit	Bit 7: Toggle Bit	Bit 6 ... 0: Status

Table 29: Node-Guarding Telegram

### Toggle Bit:

The toggle bit must alternate between two subsequent responses of the actuator.

The value of the toggle bit with the first response of the actuator is 0 after activation of the guarding protocol.

### Status:

Status = 0: 'INITIALISATION'

Status = 4: 'STOPPED'

Status = 5: 'OPERATIONAL'

Status = 127: 'PRE-OPERATIONAL'

The identifier of the heartbeat protocol is permanently set to 1792 + Node-ID and cannot be changed.

A node guard telegram can be sent in the NMT statuses 'OPERATIONAL', 'PRE-OPERATIONAL' or 'STOPPED'.

<b>NOTICE</b>	The node-guard protocol is only enabled when the heartbeat protocol is deactivated!
---------------	---

## 9.4 State Machine

In the status word, the CANopen state machine indicates operational and error states of the drive resulting from operational transitions.

The states of the state machine can change via control word (see chapter 9.6: [Control word](#)) or due to internal events (e. g., occurrence of a fault).

The current state of the state machine can be read via the status word (see chapter 9.5: [Status word](#)).

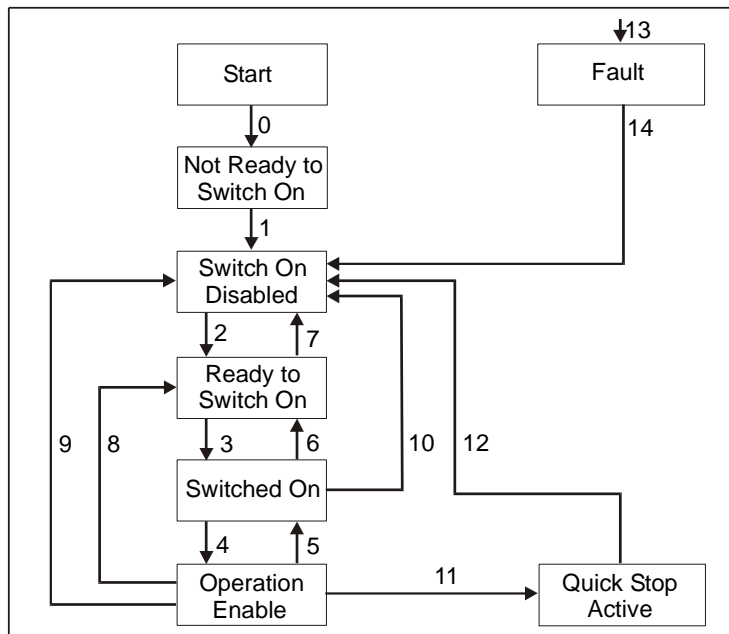

Fig. 10: State machine

The following states of the state machine of the actuator are available:

- 'NOT READY TO SWITCH ON'  
The actuator is being initialized after switching on. No travel commands can be accepted. Motor is enabled.
- 'SWITCH ON DISABLED'  
Initialization completed. No travel commands can be accepted. Motor is enabled.
- 'READY TO SWITCH ON'  
No travel commands can be accepted. Motor is enabled.
- 'SWITCHED ON'  
No travel commands can be accepted. Motor is enabled.
- 'OPERATION ENABLED'  
Travel commands can be accepted. Motor is in control state.
- 'QUICK STOP ACTIVE'  
The Quick Stop command was executed. Motor decelerates with maximum deceleration and stops with stop torque. Current positioning is cancelled. No travel commands can be accepted.
- 'FAULT'  
An error has occurred. Motor is enabled. Current positioning is cancelled. No travel commands can be accepted.

The states of the State Machine can be changed via internal events or through commands of the master via control word (see chapter 9.6: [Control word](#)).

- State change 0: START ⇒ NOT READY TO SWITCH ON  
Power on or software reset of the actuator.
- State change 1: NOT READY TO SWITCH ON ⇒ SWITCH ON DISABLED  
Initialization and self-test of the actuator successfully completed.
- State change 2: SWITCH ON DISABLED ⇒ READY TO SWITCH ON  
'Shutdown' command by master.

- State change 3: READY TO SWITCH ON ⇒ SWITCHED ON  
'Switch On' command by master.
- State change 4: SWITCHED ON ⇒ OPERATION ENABLE  
'Enable Operation' command by master.
- State change 5: OPERATION ENABLE ⇒ SWITCHED ON  
'Disable Operation' command by master.
- State change 6: SWITCHED ON ⇒ READY TO SWITCH ON  
'Shutdown' command by master.
- State change 7: READY TO SWITCH ON ⇒ SWITCH ON DISABLED  
'Disable Voltage' command by master.
- State change 8: OPERATION ENABLE ⇒ READY TO SWITCH ON  
'Shutdown' command by master.
- State change 9: OPERATION ENABLE ⇒ SWITCH ON DISABLED  
'Disable Voltage' command by master.
- State change 10: SWITCHED ON ⇒ SWITCH ON DISABLED  
'Disable Voltage' command by master.
- State change 11: OPERATION ENABLE ⇒ QUICK STOP ACTIVE  
'Quick Stop' Befehl vom Master
- State change 12: QUICK STOP ACTIVE ⇒ SWITCH ON DISABLED  
'Disable Voltage' command by master.
- State change 13: All states ⇒ FAULT  
A fault has occurred.
- State change 14: FAULT ⇒ SWITCH ON DISABLED  
'Fault Reset' command by master.

## 9.5 Status word

The status word reflects the current status of the actuator. It consists of 16 bits and is mapped on object 6041<sub>h</sub> and on the 3 Transmit PDOs.

Status word															
15	14	13	12	11	10	9	8	7	6	5	4	3	2	1	0
MSB				High Byte				Low Byte				LSB			

Table 30: Status word

The following table lists the designations of the individual bits of the status word and their meanings.

Bit	Designation	Description
0	Ready to switch on	indicates the state of the State Machine (see <a href="#">Table 32</a> )
1	Switched on	indicates the state of the State Machine (see <a href="#">Table 32</a> )
2	Operation enabled	indicates the state of the State Machine (see <a href="#">Table 32</a> )
3	Fault	indicates the state of the State Machine (see <a href="#">Table 32</a> )
4	Voltage enabled	Bit 4 is set when the supply voltage is within the tolerance limit.

Bit	Designation	Description
5	Quick stop	indicates the state of the State Machine (see <a href="#">Table 32</a> ) Bit 5 is set when the actuator is not in the 'QUICK STOP ACTIVE' state.
6	Switch on disabled	indicates the state of the State Machine (see <a href="#">Table 32</a> )
7	Warning	Bit 7 is set when a warning is active (see chapter <a href="#">7.1: Warnings</a> ).
8	Profile Position Mode: show readiness for travel	Bit 8 is set if the State Machine is in the 'OPERATION ENABLED' state und the following conditions are met: - no fault present - Supply voltage of the output stage is applied - no limit have been exceeded - no active travel job
	Profile Velocity Mode: show readiness for travel	Bit 8 is set if the State Machine is in the 'OPERATION ENABLED' state und the following conditions are met: - no fault present - no active travel job - Supply voltage of the output stage is applied
9	Remote	Bit 9 is set when the actuator is in the NMT status 'OPERATIONAL' or 'STOPPED'. The actuator receives commands via CAN interface in this case.
10	Profile Position Mode: Target reached	Bit 10 is set when the drive has come to a stop at the pre-defined target position within the defined window after a successfully executed positioning command.
	Profile Velocity Mode: Target reached	Bit 10 is set when the actual speed is within the defined window of the target speed.
11	internal Limit	Bit 11 is set when the upper or lower limits have been exceeded.
12	Profile Position Mode: Set Point Acknowledged	Bit 12 is set when the drive controller has started a travel command in the positioning mode. A travel job is started via bit 'New Setpoint' in the control word (object 6040 <sub>n</sub> : control word bit 4) (value 0 ⇒ 1). Subsequently, the controller firmware plausibilizes the target position, the operation and control parameters and the local state of the drive and sets bit 12 after the check has been passed successfully. Bit 12 is deleted when bit 4 in the control word has been reset to zero following a positioning job (Clear new setpoint).
	Profile Velocity Mode: Speed	Bit 12 is set when the drive stands still.
13	reserved	statically on 0
14	Profile Position Mode: Pos active	Bit 14 is set when there is an active positioning job in the operation mode 'Profile Position Mode' (positioning mode). <b>Notice!</b> No new setpoint is accepted and travelling in inching operation is disabled as long as bit 14 is set!
	Profile Velocity Mode	no meaning, statically on 0
15	Profile Position Mode: drive travels	The drive shaft of the actuator is moving if bit 15 is set.
	Profile Velocity Mode	statically on 0

Table 31: Bit description of the status word

The following table represents the possible states of the state machine and the resulting bit values.

The field containing an x are irrelevant for the states of the state machine.

State	Bit 7	Bit 6	Bit 5	Bit 4	Bit 3	Bit 2	Bit 1	Bit 0
Not Ready to Switch On	x	0	x	x	0	0	0	0
Switch On Disabled	x	1	x	x	0	0	0	0
Ready to Switch On	x	0	1	x	0	0	0	1
Switched On	x	0	1	x	0	0	1	1
Operation Enabled	x	0	1	x	0	1	1	1
Quick Stop Activ	x	0	0	x	0	1	1	1
Fault	x	0	x	x	1	0	0	0

Table 32: Low byte status word States of the state machine

## 9.6 Control word

The control word consists of 16 bits and is mapped on the object 6040<sub>h</sub>, and in the 3 Receive PDOs.

It contains bits for controlling the state machine as well as controlling the operational modes, Profile Position Mode (positioning mode) and Profile Velocity Mode (velocity mode).

Control word															
15	14	13	12	11	10	9	8	7	6	5	4	3	2	1	0
MSB								LSB							
High Byte								Low Byte							

Table 33: Control word

The following table lists the designations of the individual bits of the control word and their meanings.

Bit	Designation	Description
0	Switch on	controls the state of the State Machine (see <a href="#">Table 35</a> )
1	Disable voltage	controls the state of the State Machine (see <a href="#">Table 35</a> )
2	Quick stop	controls the state of the State Machine (see <a href="#">Table 35</a> )
3	Enable operation	controls the state of the State Machine (see <a href="#">Table 35</a> )
4	Profile Position Mode: New Setpoint	By bit 4, positioning is triggered in the drive controller in the OPERATION ENABLED state (value 0 ⇒ 1). The drive controller acknowledges the travel command via bit 12 'Setpoint acknowledged' in the status word (see <a href="#">chapter 9.5: Status word</a> ).
	Profile Velocity Mode	no meaning
5	reserved	
6	reserved	



Bit	Designation	Description
7	Fault reset	If the state machine of the actuator is in the FAULT state, the fault is reset by an edge on bit 7 (0 ⇒ 1) and the state machine is set to the SWITCH ON DISABLED state on the condition that the cause of the fault has been resolved in advance (see chapter 7.2: Errors).
8	Profile Position Mode: Stop	By setting bit 8 on value 1, interruption of travel can be triggered during a running positioning event. Motor runs out with programmed deceleration and stops in the control state. Positioning is resumed and completed after resetting the bit (value 1 ⇒ 0).
	Profile Velocity Mode: Stop	By bit 8, drive movement is triggered in the velocity mode in the OPERATION ENABLED state (value 1 ⇒ 0).
9	reserved	
10	reserved	
11	Key enable	Key enable can be controlled via Bit 11 in the OPERATION ENABLED state: 0 = Key enable as defined by object 2400 <sub>h</sub> sub-index 08 <sub>h</sub> 1 = Key enable inverted as defined by object 2400 <sub>h</sub> sub-index 08 <sub>h</sub>
12	reserved	
13	Profile Position Mode: Inching operation 1	Inching operation 1 is started by an edge change (value 0 ⇒ 1) on bit 13 (see chapter 4.1.3.2: Inching operation).
	Profile Velocity Mode	no meaning
14	Profile Position Mode: Inching operation 2 positive	Inching operation 2 is started in positive travel direction by an edge change (value 0 ⇒ 1) on bit 14 (see chapter 4.1.3.2: Inching operation). The drive travels in positive direction until bit 14 has been deleted.
	Profile Velocity Mode	no meaning
15	Profile Position Mode: Inching operation 2 negative	Inching operation 2 is started in negative travel direction by an edge change (value 0 ⇒ 1) on bit 15 (see chapter 4.1.3.2: Inching operation). The drive travels in negative direction until bit 15 has been deleted.
	Profile Velocity Mode	no meaning

Table 34: Bit description of the control word

The following table shows the control of the state machine with the bit combinations of the control word required.

The fields containing an x are irrelevant for the control of the state machine.

Command	Bit 7	Bit 6	Bit 5	Bit 4	Bit 3	Bit 2	Bit 1	Bit 0
Shutdown	0	x	x	x	x	1	1	0
Switch On	0	x	x	x	0	1	1	1
Disable Voltage	0	x	x	x	x	x	0	x
Quick Stop	0	x	x	x	x	0	1	x
Disable Operation	0	x	x	x	0	1	1	1

Command	Bit 7	Bit 6	Bit 5	Bit 4	Bit 3	Bit 2	Bit 1	Bit 0
Enable Operation	0	x	x	x	1	1	1	1
Fault Reset	0 ⇒ 1	x	x	x	x	x	x	x

Table 35: Low Byte Control word

<b>NOTICE</b>	<p>The states of the state machine can be changed via PDOs only.          PDOs are enabled in the NMT status Operational only.          Travel commands are enabled in the Operation Enabled state of the state machine.</p>
---------------	--

### 9.7 Flowchart of the Profile Position Mode (positioning mode)

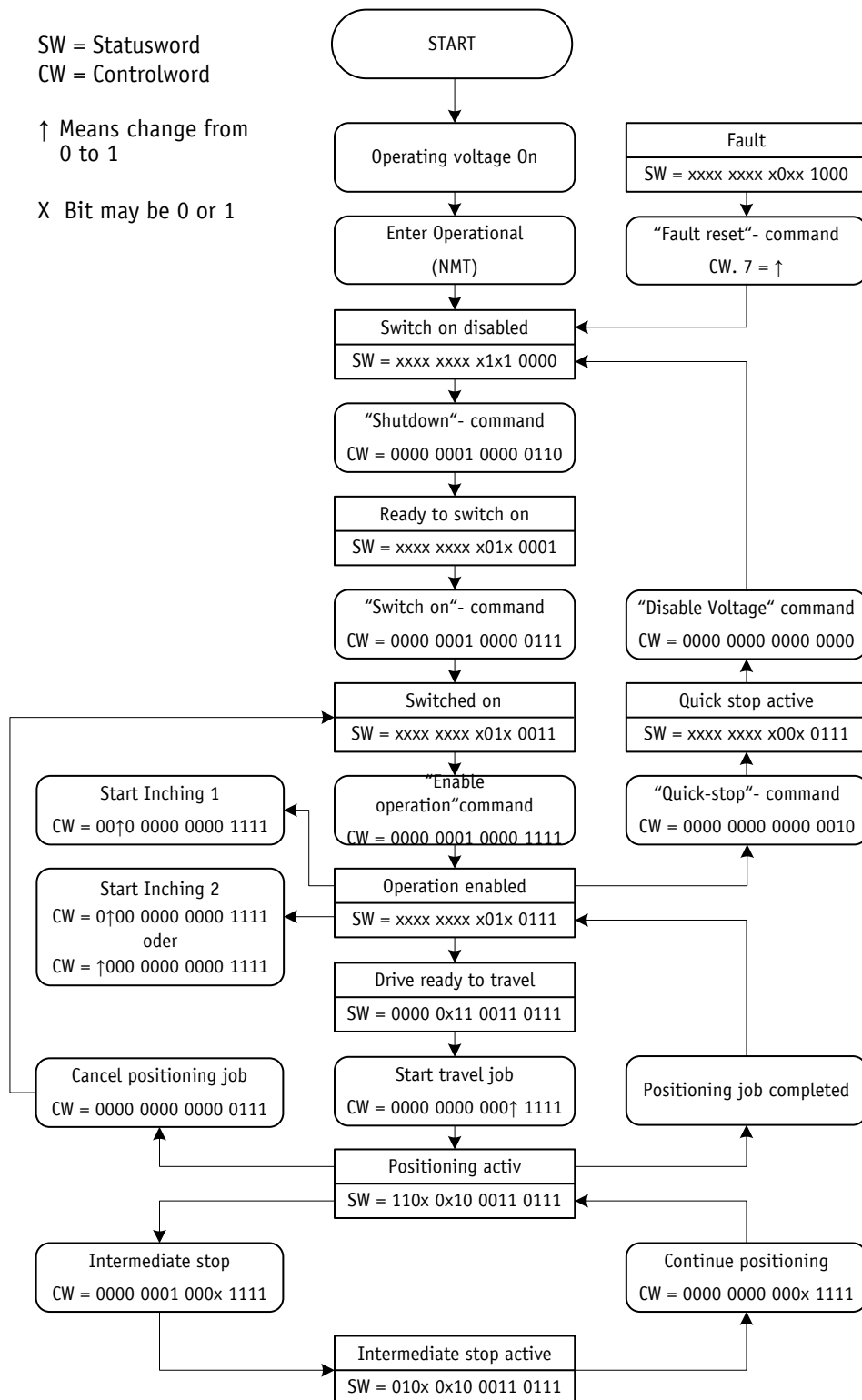

Fig. 11: Flowchart of the Profile Position Mode (positioning mode)

### 9.8 Flowchart of the Profile Velocity Mode operation mode (velocity mode)

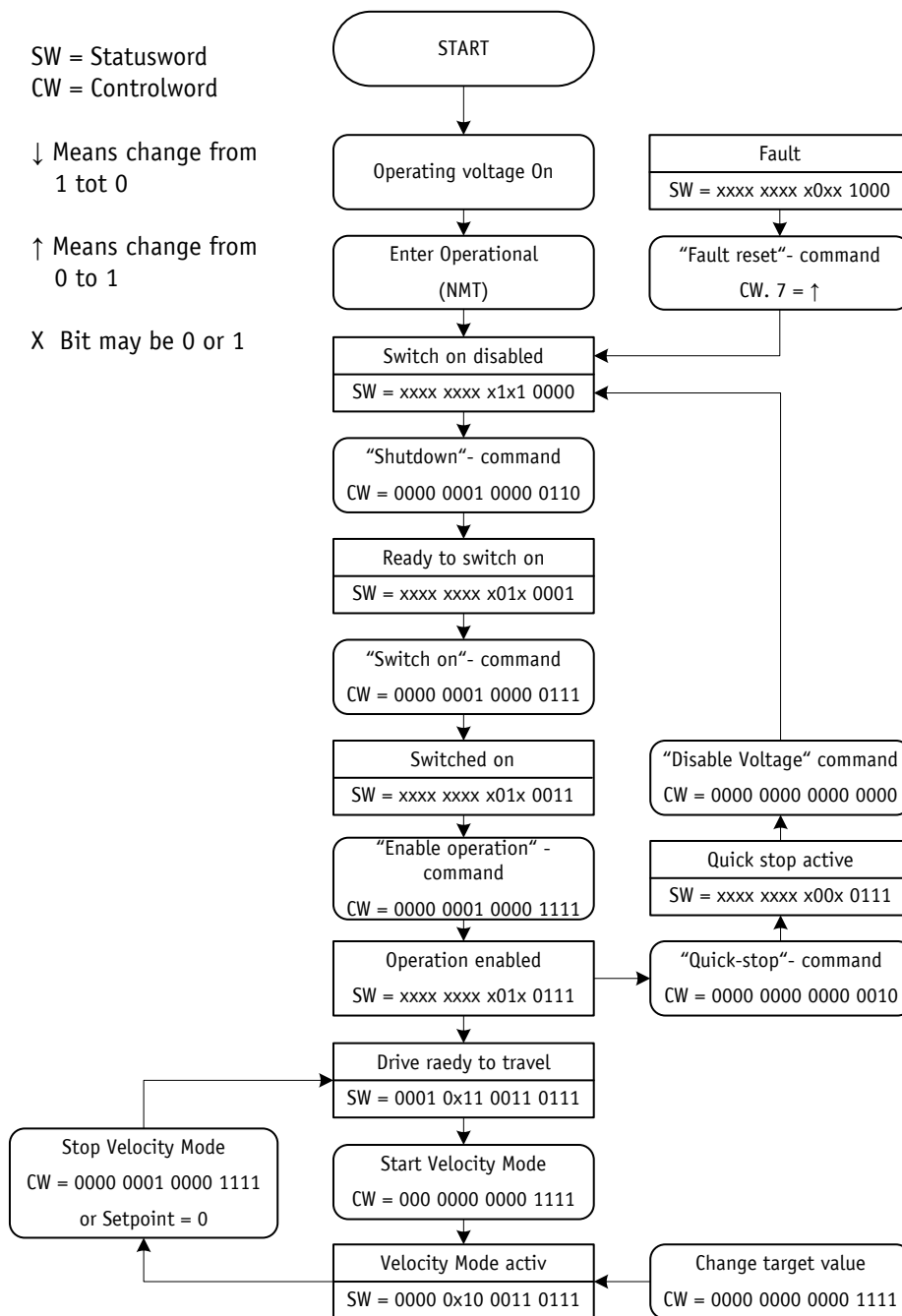

Fig. 12: Flowchart of the Profile Velocity Mode (velocity mode)

### 9.9 Examples

#### 9.9.1 Example of the Profile Position Mode (positioning mode)

In the following table a positioning example in the Profile Position Mode (positioning mode) is represented.

The node address of the actuator is 5 in this example.

Identifier	Message	Meaning
0x000	0x01 0x05	NMT: Enter OPERATIONAL
0x205	0x06 0x01	RPD01: Shutdown command
0x205	0x07 0x01	RPD01: Switch On command
0x205	0x0F 0x01	RPD01: Enable Operation command
0x405	0x1F 0x00 0x88 0x13 0x00 0x00	RPD03: Travel to position +5000
-	-	wait until target position has been reached
0x205	0x0F 0x01	RPD01: clear New Setpoint
0x405	0x1F 0x00 0x78 0xEC 0xFF 0xFF	RPD03: Travel to position -5000
0x205	0x1F 0x01	RPD01: Intermediate stop
0x205	0x1F 0x00	RPD01: continue positioning
-	-	wait until target position has been reached
0x205	0x0F 0x01	RPD01: clear New Setpoint
0x205	0x07 0x01	RPD01: Disable Operation command
0x205	0x06 0x01	RPD01: Shutdown command
0x205	0x00 0x01	RPD01: Disable Voltage command
0x000	0x80 0x05	NMT: Enter PRE-OPERATIONAL

Table 36: Positioning example in Profile Position Mode

## 9.9.2 Example of the Profile Velocity Mode (velocity mode)

In the following table an example in the Profile Velocity Mode (velocity mode) is represented. The node address of the actuator is 5 in this example. Operating mode change via parameter 20, see chapter 8: [Parameter description](#) (Default: Profile Position Mode).

Identifier	Message	Meaning
0x000	0x01 0x05	NMT: Enter OPERATIONAL
0x205	0x06 0x01	RPD01: Shutdown command
0x205	0x07 0x01	RPD01: Switch On command
0x205	0x0F 0x01	RPD01: Enable Operation command
0x505	0x0F 0x00 0x0A 0x00 0x00 0x00	RPD04: Start of velocity mode with the target speed of +10 rev/min positive sense of rotation
-	-	wait until target speed has been reached
0x505	0x0F 0x00 0x05 0x00 0x00 0x00	RPD04: Change of velocity to +5 rev/min
0x205	0x0F 0x01	RPD01: Stop drive movement
0x505	0x0F 0x00 0xF8 0xFF 0xFF 0xFF	RPD04: Start of velocity mode with the target speed of -8 rev/min (negative sense of rotation)
-	-	wait until target speed has been reached
0x205	0x0F 0x01	RPD01: Stop drive movement
0x205	0x07 0x01	RPD01: Disable Operation command
0x205	0x06 0x01	RPD01: Shutdown command
0x205	0x00 0x01	RPD01: Disable Voltage command

Identifier	Message	Meaning
0x000	0x80 0x05	NMT: Enter PRE-OPERATIONAL

Table 37: Example of Profile Velocity Mode

## 9.10 Overview of CANopen identifiers

The following table offers an overview of the identifiers used in the actuator:

Default identifier (hexadecimal)	Default identifier (decimal)	Description	Own setting
0	0	Network management (NMT)	
80	128	SYNC – Message	
80 + Node-ID	128 + Node-ID	Emergency Message	
180 + Node-ID	384 + Node-ID	TPDO1	
200 + Node-ID	512 + Node-ID	RPDO1	
380 + Node-ID	896 + Node-ID	TPDO3	
400 + Node-ID	1024 + Node-ID	RPDO3	
480 + Node-ID	1152 + Node-ID	TPDO4	
500 + Node-ID	1280 + Node-ID	RPDO4	
580 + Node-ID	1408 + Node-ID	SDO (tx)	
600 + Node-ID	1536 + Node-ID	SDO (rx)	
700 + Node-ID	1792 + Node-ID	Heartbeat Message	
700 + Node-ID	1792 + Node-ID	Node-Guard Message	

Table 38: Overview of identifiers

## 9.11 Setting the CAN baud rate

The CAN baud rate is entered via Object 2100<sub>h</sub> (CAN baud rate).

The baud rate is factory-set to 500 kbit/s.

## 9.12 EDS file

The EDS files (electronic data sheet) are available for the actuator.

This file enables easy integration and configuration of the actuator in a CANopen network using commercial CANopen configurations.

## 9.13 Directory of objects

Every CANopen device keeps a directory of objects where all parameters of the device are deposited in the form of object entries. The object entries can be accessed via SDO communication services (see chapter 9.3.7: [Service Data Objects \(SDOs\)](#)). Thus, a parameter

can be read (SDO upload) and written (SDO download) if permitted by the object entry access rights or the state of the device, respectively.

The following index ranges are used:

1000<sub>h</sub> - 1FFF<sub>h</sub> objects of the communication profile CIA DS-301 V4.0.

2000<sub>h</sub> - 5FFF<sub>h</sub> manufacturer-specific object entries.

6000<sub>h</sub> - 9FFF<sub>h</sub> objects of the device profile CIA DSP-402 V2.0.

### 9.13.1 Overview of objects

The following table offers an overview of the objects of the actuator.

Index	Name	Description	see page
1000 <sub>h</sub>	Device type	The object indicates the device profile number of the actuator.	66
1001 <sub>h</sub>	Error register	The object shows error states of the actuator.	66
1002 <sub>h</sub>	Manufacturer Status Register	Contains the system status word of the actuator (see chapter 9.2: <a href="#">System Status Word</a> ).	67
1003 <sub>h</sub>	Pre-Defined Error Field	The object stores up to 10 error messages.	67
1005 <sub>h</sub>	COB-ID Sync Message	Setting of the COB ID of the SYNC object.	68
1008 <sub>h</sub>	Manufacturer Device Name	Indicates the device name.	68
100A <sub>h</sub>	Manufacturer Software Version	Indicates the software version of the controller firmware.	69
100C <sub>h</sub>	Guard Time	Setting of the 'Guard Time' for the Node Guarding protocol (see chapter 9.3.11: <a href="#">Node Guarding</a> ).	69
100D <sub>h</sub>	Life Time Factor	Setting of the time interval 'Life Time' (see chapter 9.3.11: <a href="#">Node Guarding</a> ).	70
1011 <sub>h</sub>	Restore Default Parameters	Restoration of factory-set states of the changeable parameters and calibration of the actuator (see chapter 5: <a href="#">Calibration</a> ).	70
1014 <sub>h</sub>	COB-ID Emergency Message	Setting of the COB ID of the Emergency object.	72
1017 <sub>h</sub>	Producer Heartbeat Time	Setting of the cycle time for the heartbeat protocol (see chapter 9.3.10: <a href="#">Heartbeat protocol</a> ).	72
1018 <sub>h</sub>	Identity Objekt	Contains the Vendor ID of the device manufacturer.	73
1200 <sub>h</sub>	Server SDO Parameter	Contains the COB IDs of the default server SDO.	74
1400 <sub>h</sub>	1 <sup>st</sup> Receive PDO Parameter	Setting of the communication parameters of the RPD01.	75
1401 <sub>h</sub>	2 <sup>nd</sup> Receive PDO Parameter	Compatibility entry	77
1402 <sub>h</sub>	3 <sup>rd</sup> Receive PDO Parameter	Setting of the communication parameters of the RPD03.	78

Index	Name	Description	see page
1403 <sub>h</sub>	4 <sup>th</sup> Receive PDO Parameter	Setting of the communication parameters of the RPDO4.	80
1600 <sub>h</sub>	1 <sup>st</sup> Receive PDO Mapping Parameter	Contains the objects mapped on the RPDO1 (see chapter 9.3.6.1: 1st Receive PDO (RPDO1)).	82
1601 <sub>h</sub>	2 <sup>nd</sup> Receive PDO Mapping Parameter	Compatibility entry	82
1602 <sub>h</sub>	3 <sup>rd</sup> Receive PDO Mapping Parameter	Contains the objects mapped on the RPDO3 (see chapter 9.3.6.2: 3rd Receive PDO (RPDO3)).	83
1603 <sub>h</sub>	4 <sup>th</sup> Receive PDO Mapping Parameter	Contains the objects mapped on the RPDO4 (see chapter 9.3.6.3: 4th Receive PDO (RPDO4)).	84
1800 <sub>h</sub>	1 <sup>st</sup> Transmit PDO Parameter	Setting of the communication parameters of the TPDO1.	85
1801 <sub>h</sub>	2 <sup>nd</sup> Transmit PDO Parameter	Compatibility entry	87
1802 <sub>h</sub>	3 <sup>rd</sup> Transmit PDO Parameter	Setting of the communication parameters of the TPDO3.	88
1803 <sub>h</sub>	4 <sup>th</sup> Transmit PDO Parameter	Setting of the communication parameters of the TPDO4.	90
1A00 <sub>h</sub>	1 <sup>st</sup> Transmit PDO Mapping Parameter	Contains the objects mapped on the TPDO1 (see chapter 9.3.5.1: 1st Transmit PDO (TPDO1)).	93
1A01 <sub>h</sub>	2 <sup>nd</sup> Transmit PDO Mapping Parameter	Compatibility entry	93
1A02 <sub>h</sub>	3 <sup>rd</sup> Transmit PDO Mapping Parameter	Contains the objects mapped on the TPDO3 (see chapter 9.3.5.2: 3rd Transmit PDO (TPDO3)).	94
1A03 <sub>h</sub>	4 <sup>th</sup> Transmit PDO Mapping Parameter	Contains the objects mapped on the TPDO4 (see chapter 9.3.5.3: 4th Transmit PDO (TPDO4)).	95
2001 <sub>h</sub>	Manufacturer Offset	Manufacturer-specific offset value (is added internally to the position value).	96
2100 <sub>h</sub>	Can-Baud rate	Setting of the CAN baud rate.	96
2101 <sub>h</sub>	Node-ID	Setting of the node address.	97
2102 <sub>h</sub>	Transfer reduction	Contains the gear reduction.	97
2400 <sub>h</sub>	Display and Operation Parameter Set	Configuration of display and operation.	97
2410 <sub>h</sub>	Motor Parameter Set	Setting of the control parameters of the drive controller.	101
2412 <sub>h</sub>	Spindle Pitch	Setting of the spindle pitch.	104
2413 <sub>h</sub>	Pos Type	Setting of the positioning type.	104



Index	Name	Description	see page
2415 <sub>h</sub>	Delta Jog	Setting of the travel distance in inching operation 1.	105
2416 <sub>h</sub>	Stop Mode Inching Mode 2	Setting of the stop behaviour in inching operation 2.	105
2417 <sub>h</sub>	Inpos Mode	Setting of the behaviour upon reaching the positioning window.	105
2418 <sub>h</sub>	Loop Length	Setting the loop length.	106
2419 <sub>h</sub>	Contouring Error Limit	Setting the contouring error limit.	106
241A <sub>h</sub>	Contouring Error	Current contouring error	106
241B <sub>h</sub>	Power Supply Voltage	Voltage supply of output stage and control.	107
241C <sub>h</sub>	Output Stage Temperature	Output stage temperature.	107
241E <sub>h</sub>	Motor Current	Actual motor current	108
2421 <sub>h</sub>	Motor Current Limit	Setting of motor current limitation.	108
2423 <sub>h</sub>	Battery Voltage	Actual battery voltage	108
2424 <sub>h</sub>	Motor thermal load	Thermal overload motor	109
2450 <sub>h</sub>	Inching 2 Offset	Offset value in inching operation 2.	109
2451 <sub>h</sub>	Type of acceleration Inching Mode 2	Type of acceleration in inching operation 2.	109
2500 <sub>h</sub>	Production Date	Contains the drive's production date.	110
2900 <sub>h</sub>	Error counters	Fault counter	110
2501 <sub>h</sub>	Display Software Version	Indicates the software version of the display controller firmware.	110
6040 <sub>h</sub>	Controlword	Contains the control word of the state machine for drives.	111
6041 <sub>h</sub>	Statusword	Contains the status word of the state machine for drives.	111
6060 <sub>h</sub>	Modes of Operation	Setting of the operation mode: Profile Position Mode / Profile Velocity Mode.	112
6061 <sub>h</sub>	Modes of Operation Display	Operating mode set.	113
6064 <sub>h</sub>	Position Actual Value	Contains the absolute actual position in the operation mode Profile Position Mode (positioning mode).	113
6067 <sub>h</sub>	Position Window	Setting of the tolerance window.	114
606C <sub>h</sub>	Velocity Actual Value	Contains the actual velocity in the operation mode Profile Velocity Mode (velocity mode).	114
607A <sub>h</sub>	Target Position	Contains the target position in the operation mode Profile Position Mode (positioning mode).	114
607C <sub>h</sub>	Calibration Value	Calibration	115
607D <sub>h</sub>	Software Position Limit	Setting of the limits.	115

Index	Name	Description	see page
607E <sub>h</sub>	Polarity	Setting of the polarity.	116
6091 <sub>h</sub>	Gear Ratio	Setting of gear ratio.	116
60FF <sub>h</sub>	Target Velocity	Contains the target velocity in the operation mode Profile Velocity Mode (velocity mode).	117

Table 39: Overview of objects

### 9.13.2 Description of objects

Below, all objects of the actuator are described sorted by their indexes.

#### 9.13.2.1 1000<sub>h</sub>: Device Type

Object 1000<sub>h</sub> indicates the device profile number.

Sub-index	00 <sub>h</sub>
Description	Information on the device profile
Access	read-only
PDO mapping	no
Data type	Unsigned32
Default	00000192 <sub>h</sub>
EEPROM	no

Format description:

Bit 31 - 24	Manufacturer-specific (not used)
Bit 23 - 16	drive type (not used)
Bit 15 - 0	device profile number

#### 9.13.2.2 1001<sub>h</sub>: Error Register

Object 1001<sub>h</sub> indicates the error state of the device.

Sub-index	00 <sub>h</sub>
Description	current error code
Access	read-only
PDO mapping	no
Data type	Unsigned8
Default	no
EEPROM	no

Format description:

Bit 7	Manufacturer-specific error
-------	-----------------------------

Bit 6	reserved (statically 0)
Bit 5	Drive shaft blocked
Bit 4	Error during data transfer
Bit 3	Temperature
Bit 2	Voltage
Bit 1	Current
Bit 0	General error (is set when error is present)

A detailed error evaluation can be attained via object 1003<sub>h</sub> (Predefined Error Field). Faults and errors are signalled at the time of their occurrence by an emergency message (see chapter 9.3.9: [Emergency Object \(EMCY\)](#)).

### 9.13.2.3 1002<sub>h</sub>: Manufacturer Status Register

Object 1002<sub>h</sub> indicates the system status word of the actuator (see chapter 9.2: [System Status Word](#)).

Sub-index	00 <sub>h</sub>
Description	Manufacturer-specific status register
Access	read-only
PDO mapping	no
Data type	Unsigned32
Default	no
EEPROM	no

Format description:

Bit 31 - 16	not used
Bit 15 - 0	see chapter 9.2: <a href="#">System Status Word</a>

### 9.13.2.4 1003<sub>h</sub>: Pre-defined Error Field

Object 1003<sub>h</sub> stores the last 10 causes of faults.

The entry under sub-index 00<sub>h</sub> contains the number of faults currently stored.

The latest fault message is stored under sub-index 01<sub>h</sub>.

Writing a '0' on sub-index 00<sub>h</sub> resets the fault buffer.

Sub-index	00 <sub>h</sub>
Description	number of fault messages
Access	read-write (recordable in the "Pre-Operational" and "Operational" states, cannot be written with active travel job)
PDO mapping	no
Data type	Unsigned8
Default	0
EEPROM	no
Value range	0 ... 10

Sub-index	01 <sub>h</sub> ... 0A <sub>h</sub>
Description	faults that occurred
Access	read-only
PDO mapping	no
Data type	Unsigned32
Default	no
EEPROM	yes

Format description:

Bit 31 - 16	not used
Bit 15 - 8	error code high byte (see chapter <a href="#">9.3.9.1: Error Code</a> )
Bit 7 - 0	error code low byte (see chapter <a href="#">9.3.9.1: Error Code</a> )

### 9.13.2.5 1005<sub>h</sub>: COB-ID Sync Message

The COB-ID of the SYNC object is set via object 1005<sub>h</sub>.

The SYNC message is sent to all network participants (broadcast object).

Sub-index	00 <sub>h</sub>
Description	COB-ID SYNC message (recordable in the "Pre-Operational" state)
Access	read-write
PDO mapping	no
Data type	Unsigned32
Default	80 <sub>h</sub>
EEPROM	no

Format description:

Bit 31 - 30	not used
Bit 29	0 = 11-bit identifier (CAN 2.0A) 1 = 29-bit identifier (CAN 2.0B)
Bit 28 - 11	if bit 29=1, Bit 28 ... 11 des 29-bit identifier
Bit 10 - 0	bit 10 ... 0 of the identifier

### 9.13.2.6 1008<sub>h</sub>: Manufacturer Device Name

Object 1008<sub>h</sub> indicates the device name.

Sub-index	00 <sub>h</sub>
Description	Device name in ASCII characters
Access	const
PDO mapping	no
Data type	Visible String
Default	no

EEPROM	no
--------	----

Format description (example):

Bit 7 - 0	41 <sub>h</sub> = ' A ' (ASCII character, ISO 8859)
Bit 15 - 8	47 <sub>h</sub> = ' G ' (ASCII character, ISO 8859)
Bit 23 - 16	30 <sub>h</sub> = ' 0 ' (ASCII character, ISO 8859)
Bit 31 - 24	35 <sub>h</sub> = ' 5 ' (ASCII character, ISO 8859)

Device name = AG05

### 9.13.2.7 100A<sub>n</sub>: Manufacturer Software Version

Object 100A<sub>n</sub> indicates the software version of the controller firmware.

Sub-index	00 <sub>h</sub>
Description	Software version as ASCII characters
Access	const
PDO mapping	no
Data type	Visible String
Default	no
EEPROM	no

Format description (example):

Bit 7 - 0	31 <sub>h</sub> = ' 1 ' (ASCII character, ISO 8859)
Bit 15 - 8	2E <sub>h</sub> = ' . ' (ASCII character, ISO 8859)
Bit 23 - 16	30 <sub>h</sub> = ' 0 ' (ASCII character, ISO 8859)
Bit 31 - 24	30 <sub>h</sub> = ' 0 ' (ASCII character, ISO 8859)

Software version = V 1.00

### 9.13.2.8 100C<sub>n</sub>: Guard Time

The cycle time 'Guard Time' for node guarding is set via object 100C<sub>n</sub>. The cycle time 'Guard Time' is given in milliseconds (see chapter [9.3.11: Node Guarding](#)).

Sub-index	00 <sub>h</sub>
Description	Guard Time
Access	read-write (recordable in the "Pre-Operational" and "Operational" states)
PDO mapping	no
Unit	milliseconds
Data type	Unsigned16
Default	no
EEPROM	no

#### Data description:

Value '0' means that node guarding is deactivated.

**9.13.2.9 100D<sub>h</sub>: Life Time Factor**

The time interval 'Life Time' for life guarding is set via object 100D<sub>h</sub> (see chapter 9.3.11: [Node Guarding](#)).

Sub-index	00 <sub>h</sub>
Description	Life Time Faktor (recordable in the "Pre-Operational" and "Operational" states)
Access	read-write
PDO mapping	no
Data type	Unsigned8
Default	0
EEPROM	no

**Data description:**

Value '0' means that Life Guarding is deactivated.

**9.13.2.10 1011<sub>h</sub>: Restore Default Parameters**

The default values of the changeable parameters can be retrieved via object 1011<sub>h</sub>.

Parameter ranges are specified by selecting the respective subindex:

Sub-index 01<sub>h</sub>: set all parameters to default values

Sub-index 04<sub>h</sub>: set only standard parameters to default values

Sub-index 05<sub>h</sub>: set only control parameters to default values

Sub-index 06<sub>h</sub>: calibrate the actuator

Sub-index 07<sub>h</sub>: set only display parameter to default

Sub-index	00 <sub>h</sub>
Description	Number of subindexes
Access	read-only
PDO mapping	no
Data type	Unsigned8
Default	5
EEPROM	no

Sub-index	01 <sub>h</sub>
Description	set all parameters to default values
Access	read-write (recordable in the "Pre-Operational" and "Operational" states, cannot be written with active travel job)
PDO mapping	no
Data type	Unsigned32
Default	no
EEPROM	no

Sub-index	04 <sub>h</sub>
Description	set standard parameters to default values
Access	read-write (recordable in the "Pre-Operational" and "Operational" states, cannot be written with active travel job)
PDO mapping	no
Data type	Unsigned32
Default	no
EEPROM	no

Sub-index	05 <sub>h</sub>
Description	set controller parameters to default values
Access	read-write (recordable in the "Pre-Operational" and "Operational" states, cannot be written with active travel job)
PDO mapping	no
Data type	Unsigned32
Default	no
EEPROM	no

Sub-index	06 <sub>h</sub>
Description	calibrate the actuator
Access	read-write (recordable in the "Pre-Operational" and "Operational" states, cannot be written with active travel job)
PDO mapping	no
Data type	Unsigned32
Default	no
EEPROM	no

Sub-index	07 <sub>h</sub>
Description	Set display parameter to default
Access	read-write (recordable in the "Pre-Operational" and "Operational" states, cannot be written with active travel job)
PDO mapping	no
Data type	Unsigned32
Default	no
EEPROM	no

Format description sub-index 01<sub>h</sub>, 04<sub>h</sub> – 07<sub>h</sub>:

Bit 31 - 24	64 <sub>h</sub> = ' d ' (ASCII character, ISO 8859)
Bit 23 - 16	61 <sub>h</sub> = ' a ' (ASCII character, ISO 8859)
Bit 15 - 8	6F <sub>h</sub> = ' o ' (ASCII character, ISO 8859)
Bit 7 - 0	6C <sub>h</sub> = ' l ' (ASCII character, ISO 8859)

By writing the signature 'load' to a sub-index 01, 04 ... 07, the factory settings (see chapter 8: [Parameter description](#) ⇒ Default column) of the respective parameters are retrieved. By writing the signature 'load' to sub-index 06, the actuator is calibrated (see chapter 5: [Calibration](#)).

### 9.13.2.11 1014<sub>h</sub>: COB-ID Emergency Message

The COB-ID of the Emergency object is set via object 1014<sub>h</sub> (see chapter 9.3.9: [Emergency Object \(EMCY\)](#)).

Sub-index	00 <sub>h</sub>
Description	COB-ID der Emergency-Message
Access	read-write (recordable in the "Pre-Operational" state)
PDO mapping	no
Data type	Unsigned32
Default	80 <sub>h</sub> + Node-ID
EEPROM	no

Format description:

Bit 31	0 = EMCY exists / is valid 1 = EMCY does not exist / is not valid
Bit 30	reserved (always 0)
Bit 29	0 = 11-bit identifier (CAN 2.0A) 1 = 29-bit identifier (CAN 2.0B)
Bit 28 - 11	if bit 29=1, bit 28 ... 11 of the 29-bit identifier
Bit 10 - 0	bit 10 ... 0 of the identifier

### 9.13.2.12 1017<sub>h</sub>: Producer Heartbeat Time

The cycle time 'Heartbeat Time' for the heartbeat protocol is set via object 1017<sub>h</sub>. The 'Heartbeat Time' is given in milliseconds (see chapter 9.3.10: [Heartbeat protocol](#)).

Sub-index	00 <sub>h</sub>
Description	Producer Heartbeat Time
Access	read-write (recordable in the "Pre-Operational" and "Operational" states)
PDO mapping	no
Unit	milliseconds
Data type	Unsigned16
Default	0
EEPROM	no

#### Data description:

Value '0' means that the heartbeat protocol is deactivated.



**9.13.2.13 1018<sub>h</sub>: Identity Object**

The Vendor ID of the manufacturer is indicated via object 1018<sub>h</sub>.

Sub-index	00 <sub>h</sub>
Description	Number of subindexes
Access	read-only
PDO mapping	no
Data type	Unsigned8
Default	4
EEPROM	no

Sub-index	01 <sub>h</sub>
Description	Vendor - ID
Access	read-only
PDO mapping	no
Data type	Unsigned32
Default	195 <sub>h</sub> (SIKO GmbH)
EEPROM	no

Sub-index	02 <sub>h</sub>
Description	Product Code (no function: Compatibility entry)
Access	read-only
PDO mapping	no
Data type	Unsigned32
Default	0
EEPROM	no

Sub-index	03 <sub>h</sub>
Description	Revision Number (no function: Compatibility entry)
Access	read-only
PDO mapping	no
Data type	Unsigned32
Default	0
EEPROM	no

Sub-index	04 <sub>h</sub>
Description	Serial Number
Access	read-only
PDO mapping	no
Data type	Unsigned32
Default	no

EEPROM	no
--------	----

**Vendor-ID:**

The Vendor ID is assigned by the CAN user organization CiA e. V. (CAN in Automation).

Vendor ID '195<sub>h</sub>' has been assigned to the company SIKO GmbH.

**9.13.2.14 1200<sub>h</sub>: Server SDO Parameter**

The COB IDs for the Default Server SDO are indicated via object 1200<sub>h</sub> (see chapter [9.3.7: Service Data Objects \(SDOs\)](#)).

Sub-index	00 <sub>h</sub>
Description	Number of subindexes
Access	read-only
PDO mapping	no
Data type	Unsigned8
Default	2
EEPROM	no

Sub-index	01 <sub>h</sub>
Description	COB-ID Master ⇒ actuator (rx)
Access	read-only
PDO mapping	no
Data type	Unsigned32
Default	600 <sub>h</sub> + Node-ID
EEPROM	no

Sub-index	02 <sub>h</sub>
Description	COB-ID Stellantrieb ⇒ Master (tx)
Access	read-only
PDO mapping	no
Data type	Unsigned32
Default	580 <sub>h</sub> + Node-ID
EEPROM	no

Format description:

Bit 31	0 = SDO valid 1 = SDO not valid
Bit 30	reserved (statically 0)
Bit 29	0 = 11-bit identifier (CAN 2.0A) 1 = 29-bit identifier (CAN 2.0B)
Bit 28 - 11	if bit 29=1, bit 28 ... 11 of the 29-bit identifier
Bit 10 - 7	4 bit function code of the identifier

Bit 6 - 0	7 bit Node ID of the identifier
-----------	---------------------------------

**Data description:**

The default DSO cannot be changed (according to the CiA DS-301 Predefined Connection Set).

**9.13.2.15 1400<sub>h</sub>: 1<sup>st</sup> Receive PDO Parameter**

Durch das Objekt 1400<sub>h</sub> werden die Kommunikationsparameter des ersten Receive-PDOs (RPDO1) eingestellt.

Sub-index	00 <sub>h</sub>
Description	largest sub-index supported
Access	read-only
PDO mapping	no
Data type	Unsigned8
Default	5
EEPROM	no

Sub-index	01 <sub>h</sub>
Description	COB-ID
Access	read-write (recordable in the "Pre-Operational" state)
PDO mapping	no
Data type	Unsigned32
Default	200 <sub>h</sub> + Node-ID
EEPROM	no

Sub-index	02 <sub>h</sub>
Description	Transfer type (see chapter <a href="#">9.3.6.4: Transfer types of the Receive PDOs</a> )
Access	read-write (recordable in the "Pre-Operational" state)
PDO mapping	no
Data type	Unsigned8
Default	255
EEPROM	no

Sub-index	03 <sub>h</sub>
Description	Inhibit Time (no function: Compatibility entry)
Access	read
PDO mapping	no
Data type	Unsigned16
Default	0
EEPROM	no

Sub-index	05 <sub>h</sub>
Description	Event Timer (no function: Compatibility entry)
Access	read
PDO mapping	no
Data type	Unsigned16
Default	0
EEPROM	no

Format description sub-index 01<sub>h</sub>:

Bit 31	0 = PDO exists / is valid 1 = PDO does not exist / is not valid
Bit 30	not used
Bit 29	0 = 11-bit identifier (CAN 2.0A) 1 = 29-bit identifier (CAN 2.0B)
Bit 28 - 11	if bit 29=1, bit 28 ... 11 of the 29-bit identifier
Bit 10 - 7	4 bit function code of the identifier
Bit 6 - 0	7 bit Node ID of the identifier

Data description sub-index 02<sub>h</sub>:

0	synchronous: RPDO1 is processed only after a SYNC message has been received
1 ... 240	synchronous: identical with value 0
241 ... 251	reserved
252	reserved
253	reserved
254	identical with value 255
255	asynchronous: RPDO1 is immediately processed

### PDO mapping:

See object 1600<sub>h</sub> (1<sup>st</sup> receive PDO mapping parameter).

### Processing of PDOs:

Receive PDOs are processed in the NMT status 'OPERATIONAL' only. It is not recommended to change the transfer type of the RPDO1 since otherwise the functioning of the state machine would no longer be ensured.

### Changing PDO parameters:

PDO parameters can be changed in the NMT status 'PRE-OPERATIONAL' only.

**9.13.2.16 1401<sub>n</sub>: 2<sup>nd</sup> Receive PDO Parameter**

Object 1401<sub>n</sub> was implemented for compatibility reasons only and has no function.

Sub-index	00 <sub>n</sub>
Description	largest sub-index supported
Access	read-only
PDO mapping	no
Data type	Unsigned8
Default	5
EEPROM	no

Sub-index	01 <sub>n</sub>
Description	COB-ID (no function: Compatibility entry)
Access	read-only
PDO mapping	no
Data type	Unsigned32
Default	301 <sub>n</sub>
EEPROM	no

Sub-index	02 <sub>n</sub>
Description	Transfer type (no function: Compatibility entry)
Access	read-only
PDO mapping	no
Data type	Unsigned8
Default	255
EEPROM	no

Sub-index	03 <sub>n</sub>
Description	Inhibit Time (no function: Compatibility entry)
Access	read-only
PDO mapping	no
Data type	Unsigned16
Default	0
EEPROM	no

Sub-index	05 <sub>h</sub>
Description	Event Timer (no function: Compatibility entry)
Access	read-only
PDO mapping	no
Data type	Unsigned16
Default	0
EEPROM	no

### 9.13.2.17 1402<sub>h</sub>: 3<sup>rd</sup> Receive PDO Parameter

The communication parameters of the third Receive PDO (RPD03) are set via object 1402<sub>h</sub>.

Sub-index	00 <sub>h</sub>
Description	largest sub-index supported
Access	read-only
PDO mapping	no
Data type	Unsigned8
Default	5
EEPROM	no

Sub-index	01 <sub>h</sub>
Description	COB-ID
Access	read-write (recordable in the "Pre-Operational" state)
PDO mapping	no
Data type	Unsigned32
Default	400 <sub>h</sub> + Node-ID
EEPROM	no

Sub-index	02 <sub>h</sub>
Description	Transfer type (see chapter 9.3.6.4: <a href="#">Transfer types of the Receive PDOs</a> )
Access	read-write (recordable in the "Pre-Operational" state)
PDO mapping	no
Data type	Unsigned8
Default	255
EEPROM	no

Sub-index	03 <sub>h</sub>
Description	Inhibit Time (no function: Compatibility entry)
Access	read
PDO mapping	no
Data type	Unsigned16
Default	0
EEPROM	no

Sub-index	05 <sub>h</sub>
Description	Event Timer (no function: Compatibility entry)
Access	read
PDO mapping	no
Data type	Unsigned16
Default	0
EEPROM	no

Format description sub-index 01<sub>h</sub>:

Bit 31	0 = PDO exists / is valid 1 = PDO does not exist / is not valid
Bit 30	not used
Bit 29	0 = 11-bit identifier (CAN 2.0A) 1 = 29-bit identifier (CAN 2.0B)
Bit 28 - 11	if bit 29=1, bit 28 ... 11 of the 29-bit identifier
Bit 10 - 7	4 bit function code of the identifier
Bit 6 - 0	7 bit Node ID of the identifier

Data description sub-index 02<sub>h</sub>:

0	synchronous: RPDO1 is processed only after a SYNC message has been received
1 ... 240	synchronous: identical with value 0
241 ... 251	reserved
252	reserved
253	reserved
254	identical with value 255
255	asynchronous: RPDO1 is immediately processed

### PDO mapping:

See object 1602<sub>h</sub> (3<sup>rd</sup> receive PDO mapping parameter).

### Processing of PDOs:

Receive PDOs are processed in the NMT status 'OPERATIONAL' only.

**Changing PDO parameters:**

PDO parameters can be changed in the NMT status 'PRE-OPERATIONAL' only.

**9.13.2.18 1403<sub>h</sub>: 4<sup>th</sup> Receive PDO Parameter**

The communication parameters of the fourth Receive PDO (RPD04) are set via object 1403<sub>h</sub>.

Sub-index	00 <sub>h</sub>
Description	largest sub-index supported
Access	read-only
PDO mapping	no
Data type	Unsigned8
Default	5
EEPROM	no

Sub-index	01 <sub>h</sub>
Description	COB-ID
Access	read-write (recordable in the "Pre-Operational" state)
PDO mapping	no
Data type	Unsigned32
Default	500 <sub>h</sub> + Node-ID
EEPROM	no

Sub-index	02 <sub>h</sub>
Description	Transfer type (see chapter <a href="#">9.3.6.4: Transfer types of the Receive PDOs</a> )
Access	read-write (recordable in the "Pre-Operational" state)
PDO mapping	no
Data type	Unsigned8
Default	255
EEPROM	no

Sub-index	03 <sub>h</sub>
Description	Inhibit Time (no function: Compatibility entry)
Access	read
PDO mapping	no
Data type	Unsigned16
Default	0
EEPROM	no



Sub-index	05 <sub>h</sub>
Description	Event Timer (no function: Compatibility entry)
Access	read
PDO mapping	no
Data type	Unsigned16
Default	0
EEPROM	no

Format description sub-index 01<sub>h</sub>:

Bit 31	0 = PDO exists / is valid 1 = PDO does not exist / is not valid
Bit 30	not used
Bit 29	0 = 11-bit identifier (CAN 2.0A) 1 = 29-bit identifier (CAN 2.0B)
Bit 28 - 11	if bit 29=1, bit 28 ... 11 of the 29-bit identifier
Bit 10 - 7	4 bit function code of the identifier
Bit 6 - 0	7 bit Node ID of the identifier

Data description sub-index 02<sub>h</sub>:

0	synchronous: RPDO1 is processed only after a SYNC message has been received
1 ... 240	synchronous: identical with value 0
241 ... 251	reserved
252	reserved
253	reserved
254	identical with value 255
255	asynchronous: RPDO1 is immediately processed

### PDO mapping:

See object 1603<sub>h</sub> (4<sup>th</sup> receive PDO mapping parameter).

### Processing of PDOs:

Receive PDOs are processed in the NMT status 'OPERATIONAL' only.

### Changing PDO parameters:

PDO parameters can be changed in the NMT status 'PRE-OPERATIONAL' only.

**9.13.2.19 1600<sub>n</sub>: 1<sup>st</sup> Receive PDO Mapping Parameter**

Object 1600<sub>n</sub> determines the objects that are mapped on the first Receive PDO (RPDO1).

Sub-index	00 <sub>n</sub>
Description	Number of mapped application objects in RPDO 1
Access	read-only
PDO mapping	no
Data type	Unsigned8
Default	1
EEPROM	no

Sub-index	01 <sub>n</sub>
Description	first object mapped
Access	read-only
PDO mapping	no
Data type	Unsigned32
Default	60400010 <sub>h</sub>
EEPROM	no

Format description sub-index 01<sub>n</sub>:

Bit 31 - 16	Index 16 bits
Bit 15 - 8	Sub-index 8 bits
Bit 7 - 0	8 bits object length

**Data description:**

The object cannot be changed (static mapping).

**Mapped objects:**

- Object 6040<sub>h</sub> (control word) in bytes 0 and 1.

**9.13.2.20 1601<sub>n</sub>: 2<sup>nd</sup> Receive PDO Mapping Parameter**

Object 1601<sub>n</sub> was implemented for compatibility reasons only and has no function.

Sub-index	00 <sub>n</sub>
Description	Number of mapped application objects in RPDO 2
Access	read-only
PDO mapping	no
Data type	Unsigned8
Default	0
EEPROM	no

### 9.13.2.21 1602<sub>n</sub>: 3<sup>rd</sup> Receive PDO Mapping Parameter

Object 1602<sub>n</sub> determines the objects that are mapped on the third Receive PDO (RPDO3).

Sub-index	00 <sub>n</sub>
Description	Number of mapped application objects in RPDO 3
Access	read-only
PDO mapping	no
Data type	Unsigned8
Default	2
EEPROM	no

Sub-index	01 <sub>n</sub>
Description	first object mapped
Access	read-only
PDO mapping	no
Data type	Unsigned32
Default	60400010 <sub>h</sub>
EEPROM	no

Sub-index	02 <sub>n</sub>
Description	second object mapped
Access	read-only
PDO mapping	no
Data type	Unsigned32
Default	607A0020 <sub>h</sub>
EEPROM	no

Format description sub-index 01<sub>n</sub> – 02<sub>n</sub>:

Bit 31 - 16	index 16 bits
Bit 15 - 8	sub-index 8 bits
Bit 7 - 0	8 bits object length

#### Data Description:

The object cannot be changed (static mapping).

#### Mapped objects:

- Object 6040<sub>h</sub> (control word) in bytes 0 and 1.
- Object 607A<sub>h</sub> (target position) in bytes 2 to 5.

### 9.13.2.22 1603<sub>h</sub>: 4<sup>th</sup> Receive PDO Mapping Parameter

Object 1603<sub>h</sub> determines the objects that are mapped on the fourth Receive PDO (RPDO4).

Sub-index	00 <sub>h</sub>
Description	Number of mapped application objects in RPDO 4
Access	read-only
PDO mapping	no
Data type	Unsigned8
Default	2
EEPROM	no

Sub-index	01 <sub>h</sub>
Description	first object mapped
Access	read-only
PDO mapping	no
Data type	Unsigned32
Default	60400010 <sub>h</sub>
EEPROM	no

Sub-index	02 <sub>h</sub>
Description	second object mapped
Access	read-only
PDO mapping	no
Data type	Unsigned32
Default	60FF0020 <sub>h</sub>
EEPROM	no

Format description sub-index 01<sub>h</sub> – 02<sub>h</sub>:

Bit 31 - 16	index 16 bits
Bit 15 - 8	sub-index 8 bits
Bit 7 - 0	8 bits object length

#### Data description:

The object cannot be changed (static mapping).

#### Mapped objects:

- Object 6040<sub>h</sub> (control word) in bytes 0 and 1.
- Object 60FF<sub>h</sub> (target velocity) in bytes 2 to 5.

**9.13.2.23 1800<sub>n</sub>: 1<sup>st</sup> Transmit PDO Parameter**

The communication parameters of the first Transmit PDO (TPDO1) are set via object 1800<sub>n</sub>.

Sub-index	00 <sub>n</sub>
Description	largest sub-index supported
Access	read-only
PDO mapping	no
Data type	Unsigned8
Default	5
EEPROM	no

Sub-index	01 <sub>n</sub>
Description	COB-ID
Access	read-write (recordable in the "Pre-Operational" state)
PDO mapping	no
Data type	Unsigned32
Default	180 <sub>n</sub> + Node-ID
EEPROM	no

Sub-index	02 <sub>n</sub>
Description	Transfer type (see chapter <a href="#">9.3.6.4: Transfer types of the Receive PDOs</a> )
Access	read-write (recordable in the "Pre-Operational" state)
PDO mapping	no
Data type	Unsigned8
Default	255
EEPROM	no

Sub-index	03 <sub>n</sub>
Description	Inhibit Time
Access	read-write (recordable in the "Pre-Operational" state)
PDO mapping	no
Unit	x 100 μs
Data type	Unsigned16
Default	100
EEPROM	no

Sub-index	05 <sub>h</sub>
Description	Event Timer
Access	read-write (recordable in the "Pre-Operational" state)
PDO mapping	no
Unit	milliseconds
Data type	Unsigned16
Default	0
EEPROM	no
Value range	0 ... 65535 The service is switched off by writing the value 0.

Format description sub-index 01<sub>h</sub>:

Bit 31	0 = PDO exists / is valid 1 = PDO does not exist / is not valid
Bit 30	0 = request via RTR frame enabled 1 = request via RTR frame disabled
Bit 29	0 = 11-bit identifier (CAN 2.0A) 1 = 29-bit identifier (CAN 2.0B)
Bit 28 - 11	if bit 29=1, bit 28 ... 11 of the 29-bit identifier
Bit 10 - 7	4 bit function code of the identifier
Bit 6 - 0	7 bit Node-ID of the identifier

Data description sub-index 02<sub>h</sub>:

0	synchronous: acyclic, PDO is sent after each SYNC message.
1 ... 240	synchronous: cyclic, PDO is sent after 1 ... 240 SYNC messages received.
241 ... 251	reserved
252	reserved
253	asynchronous: only on request (RTR frame). PDO is sent immediately after receipt of the RTR frame. <b>Notice!</b> Must have been enabled via bit 30 of sub-index 1.
254	asynchronous: Event-triggered (with every change of a mapped object and time-controlled)
255	asynchronous: time-triggered

### PDO mapping:

See object 1A00<sub>h</sub> (1<sup>st</sup> transmit PDO mapping parameter).

### Inhibit Time:

A send-inhibit time is specified by the 'Inhibit Time' parameter (only for transmitt type 254). Resolution is a multiple of 100 µs. The actual send-inhibit time is inaccurate and can deviate from the set value by several milliseconds.

**Event Timer:**

The 'Event Timer' parameter serves for setting a cycle time (in milliseconds) for time-triggered transfer of the Transmit PDO1. The actual cycle time is inaccurate and can deviate from the set value by several milliseconds.

**Processing of PDOs:**

Transmit PDOs are transferred in the NMT status 'OPERATIONAL' only.

It is not recommended to change the transfer type of the TPDO1 since otherwise the functioning of the state machine would no longer be ensured.

**Changing PDO parameters:**

PDO parameters can be changed in the NMT status 'PRE-OPERATIONAL' only.

**9.13.2.24 1801<sub>n</sub>: 2<sup>nd</sup> Transmit PDO Parameter**

Object 1801<sub>n</sub> was implemented for compatibility reasons only and has no function.

Sub-index	00 <sub>h</sub>
Description	largest sub-index supported
Access	read-only
PDO mapping	no
Data type	Unsigned8
Default	5
EEPROM	no

Sub-index	01 <sub>h</sub>
Description	COB-ID
Access	read-only
PDO mapping	no
Data type	Unsigned32
Default	281 <sub>h</sub>
EEPROM	no

Sub-index	02 <sub>h</sub>
Description	Transmission type (no function: Compatibility entry)
Access	read-only
PDO mapping	no
Data type	Unsigned8
Default	255
EEPROM	no

Sub-index	03 <sub>h</sub>
Description	Inhibit Time (no function: Compatibility entry)
Access	read-only
PDO mapping	no
Data type	Unsigned16
Default	0
EEPROM	no

Sub-index	05 <sub>h</sub>
Description	Event Timer (no function: Compatibility entry)
Access	read-only
PDO mapping	no
Unit	milliseconds
Data type	Unsigned16
Default	0
EEPROM	no

### 9.13.2.25 1802<sub>h</sub>: 3<sup>rd</sup> Transmit PDO Parameter

The communication parameters of the third Transmit PDO (TPD03) are set via object 1802<sub>h</sub> (TPD03) eingestellt.

Sub-index	00 <sub>h</sub>
Description	largest sub-index supported
Access	read-only
PDO mapping	no
Data type	Unsigned8
Default	5
EEPROM	no

Sub-index	01 <sub>h</sub>
Description	COB-ID
Access	read-write (recordable in the "Pre-Operational" state)
PDO mapping	no
Data type	Unsigned32
Default	380 <sub>h</sub> + Node-ID
EEPROM	no



Sub-index	02 <sub>h</sub>
Description	Transfer type (see chapter 9.3.5.4: Transfer types of the Transmit PDOs)
Access	read-write (recordable in the "Pre-Operational" state)
PDO mapping	no
Data type	Unsigned8
Default	253
EEPROM	no

Sub-index	03 <sub>h</sub>
Description	Inhibit Time
Access	read-write (recordable in the "Pre-Operational" state)
PDO mapping	no
Unit	x 100 $\mu$ s
Data type	Unsigned16
Default	100
EEPROM	no

Sub-index	05 <sub>h</sub>
Description	Event Timer
Access	read-write (recordable in the "Pre-Operational" state)
PDO mapping	no
Unit	milliseconds
Data type	Unsigned16
Default	0
EEPROM	no
Value range	0 ... 65535 The service is switched off by writing the value 0.

Format description sub-index 01<sub>h</sub>:

Bit 31	0 = PDO exists / is valid 1 = PDO does not exist / is not valid
Bit 30	0 = request via RTR frame enabled 1 = request via RTR frame disabled
Bit 29	0 = 11-bit identifier (CAN 2.0A) 1 = 29-bit identifier (CAN 2.0B)
Bit 28 - 11	if bit 29=1, bit 28 ... 11 of the 29-bit identifier
Bit 10 - 7	4 bit function code of the identifier
Bit 6 - 0	7 bit Node-ID of the identifier

Data description sub-index 02<sub>h</sub>:

0	synchronous: acyclic, PDO is sent after each SYNC message.
1 ... 240	synchronous: cyclic, PDO is sent after 1 ... 240 SYNC messages received.
241 ... 251	reserved
252	reserved
253	asynchronous: only on request (RTR frame). PDO is sent immediately after receipt of the RTR frame. <b>Notice!</b> Must have been enabled via bit 30 of sub-index 1.
254	asynchronous: Event-triggered (with every change of a mapped object and time-controlled).
255	asynchronous: time-triggered

#### **PDO mapping:**

See object 1A02<sub>h</sub> (3<sup>rd</sup> transmit PDO mapping parameter).

#### **Inhibit Time:**

A send-inhibit time is specified by the 'Inhibit Time' parameter (only for transmit type 254). Resolution is a multiple of 100 µs. The actual send-inhibit time is inaccurate and can deviate from the set value by several milliseconds.

#### **Event Timer:**

The 'Event Timer' parameter serves for setting a cycle time (in milliseconds) for time-triggered transfer of the Transmit PDO3. The actual cycle time is inaccurate and can deviate from the set value by several milliseconds.

#### **Processing of PDOs:**

Transmit PDOs are transferred in the NMT status 'OPERATIONAL' only.

#### **Changing PDO parameters:**

PDO parameters can be changed in the NMT status 'PRE-OPERATIONAL' only.

### **9.13.2.26 1803<sub>h</sub>: 4<sup>th</sup> Transmit PDO Parameter**

The communication parameters of the fourth Transmit PDO (TPDO4) are set via object 1803<sub>h</sub>.

Sub-index	00 <sub>h</sub>
Description	largest sub-index supported
Access	read-only
PDO mapping	no
Data type	Unsigned8
Default	5
EEPROM	no

Sub-index	01 <sub>h</sub>
Description	COB-ID
Access	read-write (recordable in the "Pre-Operational" state)
PDO mapping	no
Data type	Unsigned32
Default	480 <sub>h</sub> + Node-ID
EEPROM	no

Sub-index	02 <sub>h</sub>
Description	Transfer type (see chapter <a href="#">9.3.5.4: Transfer types of the Transmit PDOs</a> )
Access	read-write (recordable in the "Pre-Operational" state)
PDO mapping	no
Data type	Unsigned8
Default	253
EEPROM	no

Sub-index	03 <sub>h</sub>
Description	Inhibit Time
Access	read-write (recordable in the "Pre-Operational" state)
PDO mapping	no
Unit	x 100 $\mu$ s
Data type	Unsigned16
Default	100
EEPROM	no

Sub-index	05 <sub>h</sub>
Description	Event Timer
Access	read-write (recordable in the "Pre-Operational" state)
PDO mapping	no
Unit	milliseconds
Data type	Unsigned16
Default	0
EEPROM	no
Value range	0 ... 65535 The service is switched off by writing the value 0.

Format description sub-index 01<sub>h</sub>:

Bit 31	0 = PDO exists / is valid 1 = PDO does not exist / is not valid
Bit 30	0 = request via RTR frame enabled 1 = request via RTR frame disabled
Bit 29	0 = 11-bit identifier (CAN 2.0A) 1 = 29-bit identifier (CAN 2.0B)
Bit 28 - 11	if bit 29=1, bit 28 ... 11 of the 29-bit identifier
Bit 10 - 7	4 bit function code of the identifier
Bit 6 - 0	7 bit Node-ID of the identifier

Data description sub-index 02<sub>h</sub>:

0	synchronous: acyclic, PDO is sent after each SYNC message.
1 ... 240	synchronous: cyclic, PDO is sent after 1 ... 240 SYNC messages received.
241 ... 251	reserved
252	reserved
253	asynchronous: only on request (RTR frame). PDO is sent immediately after receipt of the RTR frame. <b>Notice!</b> Must have been enabled via bit 30 of sub-index 1.
254	asynchronous: Event-triggered (with every change of a mapped object and time-controlled).
255	asynchronous: time-triggered

### PDO mapping:

See object 1A03<sub>h</sub> (4<sup>th</sup> transmit PDO mapping parameter).

### Inhibit Time:

A send-inhibit time is specified by the 'Inhibit Time' parameter (only for transmitt type 254). Resolution is a multiple of 100 µs. The actual send-inhibit time is inaccurate and can deviate from the set value by several milliseconds.

### Event Timer:

The 'Event Timer' parameter serves for setting a cycle time (in milliseconds) for time-triggered transfer of the Transmit PDO4. The actual cycle time is inaccurate and can deviate from the set value by several milliseconds.

### Processing of PDOs:

Transmit PDOs are transferred in the NMT status 'OPERATIONAL' only.

### Changing PDO parameters:

PDO parameters can be changed in the NMT status 'PRE-OPERATIONAL' only.

**9.13.2.27 1A00<sub>h</sub>: 1<sup>st</sup> Transmit PDO Mapping Parameter**

Object 1A00<sub>h</sub> determines the objects that are mapped on the first Transmit PDO (TPDO1).

Sub-index	00 <sub>h</sub>
Description	Number of mapped application objects in TPDO 1
Access	read-only
PDO mapping	no
Data type	Unsigned8
Default	1
EEPROM	no

Sub-index	01 <sub>h</sub>
Description	first object mapped
Access	read-only
PDO mapping	no
Data type	Unsigned32
Default	60410010 <sub>h</sub>
EEPROM	no

Format description sub-index 01<sub>h</sub>:

Bit 31 - 16	index 16 bits
Bit 15 - 8	sub-index 8 bits
Bit 7 - 0	8 bits object length

**Data description:**

The object cannot be changed (static mapping).

**Mapped objects:**

- Object 6041<sub>h</sub> (status word) in bytes 0 and 1.

**9.13.2.28 1A01<sub>h</sub>: 2<sup>nd</sup> Transmit PDO Mapping Parameter**

Object 1A01<sub>h</sub> was implemented for compatibility reasons only and has no function.

Sub-index	00 <sub>h</sub>
Description	Number of mapped application objects in TPDO 2
Access	read-only
PDO mapping	no
Data type	Unsigned8
Default	0
EEPROM	no

### 9.13.2.29 1A02<sub>h</sub>: 3<sup>rd</sup> Transmit PDO Mapping Parameter

Object 1A02<sub>h</sub> determines the objects that are mapped on the third Transmit PDO (TPDO3).

Sub-index	00 <sub>h</sub>
Description	Number of mapped application objects in TPDO 3
Access	read-only
PDO mapping	no
Data type	Unsigned8
Default	2
EEPROM	no

Sub-index	01 <sub>h</sub>
Description	first object mapped
Access	read-only
PDO mapping	no
Data type	Unsigned32
Default	60410010 <sub>h</sub>
EEPROM	no

Sub-index	02 <sub>h</sub>
Description	second object mapped
Access	read-only
PDO mapping	no
Data type	Unsigned32
Default	60640020 <sub>h</sub>
EEPROM	no

Format description sub-index 01<sub>h</sub> – 02<sub>h</sub>:

Bit 31 - 16	index 16 bits
Bit 15 - 8	sub-index 8 bits
Bit 7 - 0	8 bits object length

#### Data description:

The object cannot be changed (static mapping).

#### Mapped objects:

- Object 6041<sub>h</sub> (status word) in bytes 0 and 1.
- Object 6064<sub>h</sub> (position actual value) in bytes 2 to 5.

### 9.13.2.30 1A03<sub>n</sub>: 4<sup>th</sup> Transmit PDO Mapping Parameter

Object 1A03<sub>n</sub> determines the objects that are mapped on the fourth Transmit PDO (TPDO4).

Sub-index	00 <sub>n</sub>
Description	Number of mapped application objects in TPDO 4
Access	read-only
PDO mapping	no
Data type	Unsigned8
Default	2
EEPROM	no

Sub-index	01 <sub>n</sub>
Description	first object mapped
Access	read-only
PDO mapping	no
Data type	Unsigned32
Default	60410010 <sub>h</sub>
EEPROM	no

Sub-index	02 <sub>n</sub>
Description	second object mapped
Access	read-only
PDO mapping	no
Data type	Unsigned32
Default	606C0020 <sub>h</sub>
EEPROM	no

Format description sub-index 01<sub>n</sub> – 02<sub>n</sub>:

Bit 31 - 16	index 16 bits
Bit 15 - 8	sub-index 8 bits
Bit 7 - 0	8 bits object length

#### Data description:

The object cannot be changed (static mapping).

#### Mapped objects:

- Object 6041<sub>h</sub> (status word) in bytes 0 and 1.
- Object 606C<sub>h</sub> (velocity actual value) in bytes 2 to 5.

**9.13.2.31 2001<sub>h</sub>: Manufacturer Offset**

Sub-index	00 <sub>h</sub>
Description	Manufacturer-specific offset value (see chapter 8: <a href="#">Parameter description</a> ⇒ <a href="#">Parameter no. 32</a> )
Access	read-write (recordable in the "Pre-Operational" and "Operational" states, cannot be written with active travel job)
PDO mapping	no
Data type	Integer32
Default	0
EEPROM	yes
Value range	-999999 ... 999999

**9.13.2.32 2100<sub>h</sub>: CAN baud rate**

The CAN baud rate is set via object 2100<sub>h</sub>.

Sub-index	00 <sub>h</sub>
Description	CAN baud rate (see chapter 8: <a href="#">Parameter description</a> ⇒ <a href="#">Parameter no. 33</a> )
Access	read-write (recordable in the "Pre-Operational" and "Operational" states) The baud rate set here will only be applied after re-initialisation of communication or power-up.
PDO mapping	no
Data type	Unsigned8
Default	3
EEPROM	yes
Value range	1 ... 7

**Data description:**

Value = 1:	1 Mbit/s
Value = 2:	800 kbit/s
Value = 3:	500 kbit/s
Value = 4:	250 kbit/s
Value = 5:	125 kbit/s
Value = 6:	50 kbit/s
Value = 7:	20 kbit/s



**9.13.2.33 2101<sub>h</sub>: Node-ID**

The set node ID of the actuator can be read via object 2101<sub>h</sub>.

Sub-index	00 <sub>h</sub>
Description	Node-ID (see chapter 8: <a href="#">Parameter description</a> ⇒ <a href="#">Parameter no. 22</a> )
Access	read-write (recordable in the "Pre-Operational" and "Operational" states) The node ID set here will only be applied after re-initialisation of communication or power-up Node-ID.
PDO mapping	no
Data type	Unsigned8
Default	1
EEPROM	yes
Value range	1 ... 127

**9.13.2.34 2102<sub>h</sub>: Gear reduction**

The gear reduction of the actuator can be read out via object 2102<sub>h</sub>.

Sub-index	00 <sub>h</sub>
Description	Gear reduction (see chapter 8: <a href="#">Parameter description</a> ⇒ <a href="#">Parameter no. 72</a> )
Access	read
PDO mapping	no
Data type	Unsigned8
Default	no
EEPROM	no
Value range	0 = Gear reduction 98:1 2 = Gear reduction 188:1 3 = Gear reduction 368:1 4 = Gear reduction 66:1

**9.13.2.35 2400<sub>h</sub>: Display and Operation Parameter Set**

The object 2400<sub>h</sub> contains all adjustable parameters regarding display and operation.

Sub-index	00 <sub>h</sub>
Description	largest sub-index supported
Access	read-only
PDO mapping	no
Data type	Unsigned8
Default	13
EEPROM	no

Sub-index	01 <sub>h</sub>
Description	Number of decimal places (see chapter 8: <a href="#">Parameter description</a> ⇒ <a href="#">Parameter no. 42</a> )
Access	read-write (recordable in the "Pre-Operational" and "Operational" states)
PDO mapping	no
Data type	Unsigned8
Default	0
EEPROM	yes
Value range	0 ... 4

Sub-index	02 <sub>h</sub>
Description	Display divisor (see chapter 8: <a href="#">Parameter description</a> ⇒ <a href="#">Parameter Nr. no 43</a> )
Access	read-write (recordable in the "Pre-Operational" and "Operational" states)
PDO mapping	no
Data type	Unsigned8
Default	0
EEPROM	yes
Value range	0 ... 3

Sub-index	03 <sub>h</sub>
Description	Direction indication function (see chapter 8: <a href="#">Parameter description</a> ⇒ <a href="#">Parameter no. 44</a> )
Access	read-write (recordable in the "Pre-Operational" and "Operational" states)
PDO mapping	no
Data type	Unsigned8
Default	0
EEPROM	yes
Value range	0 ... 2

Sub-index	04 <sub>h</sub>
Description	Display orientation (see chapter 8: <a href="#">Parameter description</a> ⇒ <a href="#">Parameter no. 45</a> )
Access	read-write (recordable in the "Pre-Operational" and "Operational" states)
PDO mapping	no
Data type	Unsigned8
Default	0
EEPROM	yes
Value range	0 ... 1

Sub-index	05 <sub>h</sub>
Description	PIN change (see chapter 8: <a href="#">Parameter description</a> ⇒ <a href="#">Parameter no. 48</a> )
Access	read-write (recordable in the "Pre-Operational" and "Operational" states)
PDO mapping	no
Data type	Unsigned8
Default	0
EEPROM	yes
Value range	0 ... 99999

Sub-index	06 <sub>h</sub>
Description	Displayed value 2 <sup>nd</sup> display line (see chapter 8: <a href="#">Parameter description</a> ⇒ <a href="#">Parameter no. 49</a> )
Access	read-write (recordable in the "Pre-Operational" and "Operational" states)
PDO mapping	no
Data type	Unsigned8
Default	0
EEPROM	yes
Value range	0 ... 8

Sub-index	07 <sub>h</sub>
Description	Key enable time (see chapter 8: <a href="#">Parameter description</a> ⇒ <a href="#">Parameter no. 37</a> )
Access	read-write (recordable in the "Pre-Operational" and "Operational" states)
PDO mapping	no
Data type	Unsigned8
Default	3
EEPROM	yes
Value range	1 ... 60

Sub-index	08 <sub>h</sub>
Description	Key function enable (see chapter 8: <a href="#">Parameter description</a> ⇒ <a href="#">Parameter no. 38</a> )
Access	read-write (recordable in the "Pre-Operational" and "Operational" states)
PDO mapping	no
Data type	Unsigned8
Default	0
EEPROM	yes
Value range	0 ... 1

Sub-index	09 <sub>h</sub>
Description	Key enable
Access	read-write (recordable in the "Pre-Operational" state)
PDO mapping	no
Data type	Unsigned8
Default	0
EEPROM	no
Value range	0 ... 1

Sub-index	0A <sub>h</sub>
Description	LED 2 orange (see chapter 8: <a href="#">Parameter description</a> ⇒ <a href="#">Parameter no. 39</a> )
Access	read-write (recordable in the "Pre-Operational" and "Operational" states)
PDO mapping	no
Data type	Unsigned8
Default	1
EEPROM	yes
Value range	0 ... 1

Sub-index	0B <sub>h</sub>
Description	LED 1 red (see chapter 8: <a href="#">Parameter description</a> ⇒ <a href="#">Parameter no. 40</a> )
Access	read-write (recordable in the "Pre-Operational" and "Operational" states)
PDO mapping	no
Data type	Unsigned8
Default	1
EEPROM	yes
Value range	0 ... 1

Sub-index	0C <sub>h</sub>
Description	LED 1 green (see chapter 8: <a href="#">Parameter description</a> ⇒ <a href="#">Parameter no. 41</a> )
Access	read-write (recordable in the "Pre-Operational" and "Operational" states)
PDO mapping	no
Data type	Unsigned8
Default	1
EEPROM	yes
Value range	0 ... 1

Sub-index	0D <sub>n</sub>
Description	Display divisor application (see chapter 8: <a href="#">Parameter description</a> ⇒ <a href="#">Parameter no. 74</a> )
Access	read-write (recordable in the "Pre-Operational" and "Operational" states)
PDO mapping	no
Data type	Unsigned8
Default	0
EEPROM	yes
Value range	0 ... 1

### 9.13.2.36 2410<sub>n</sub>: Motor Parameter Set

Object 2410<sub>n</sub> contains all adjustable control parameters of the drive controller.

Sub-index	00 <sub>n</sub>
Description	largest sub-index supported
Access	read-only
PDO mapping	no
Data type	Unsigned8
Default	9
EEPROM	no

Sub-index	01 <sub>n</sub>
Description	Controller parameter P (see chapter 8: <a href="#">Parameter description</a> ⇒ <a href="#">Parameter no. 1</a> )
Access	read-write (recordable in the "Pre-Operational" and "Operational" states, cannot be written with active travel job)
PDO mapping	no
Data type	Unsigned16
Default	300
EEPROM	yes
Value range	1 ... 500

Sub-index	02 <sub>n</sub>
Description	Controller parameter I (see chapter 8: <a href="#">Parameter description</a> ⇒ <a href="#">Parameter no. 2</a> )
Access	read-write (recordable in the "Pre-Operational" and "Operational" states, cannot be written with active travel job)
PDO mapping	no
Data type	Unsigned16
Default	2
EEPROM	yes
Value range	0 ... 500

Sub-index	03 <sub>h</sub>
Description	Controller parameter D (see chapter 8: <a href="#">Parameter description</a> ⇒ <a href="#">Parameter no. 3</a> )
Access	read-write (recordable in the "Pre-Operational" and "Operational" states, cannot be written with active travel job)
PDO mapping	no
Data type	Unsigned16
Default	0
EEPROM	yes
Value range	0 ... 500

Sub-index	04 <sub>h</sub>
Description	a - Pos (acceleration positioning mode) (see chapter 8: <a href="#">Parameter description</a> ⇒ <a href="#">Parameter no. 4</a> )
Access	read-write (recordable in the "Pre-Operational" and "Operational" states, cannot be written with active travel job)
PDO mapping	no
Data type	Unsigned8
Default	50
EEPROM	yes
Value range	1 ... 100

Sub-index	05 <sub>h</sub>
Description	v - Pos (velocity positioning mode) (see chapter 8: <a href="#">Parameter description</a> ⇒ <a href="#">Parameter no. 5</a> )
Access	read-write (recordable in the "Pre-Operational" and "Operational" states, cannot be written with active travel job)
PDO mapping	no
Data type	Unsigned8
Default	10
EEPROM	yes
Value range	Gear 66:1 ⇒ 1 – 75 rpm Gear 98:1 ⇒ 1 – 50 rpm Gear 188:1 ⇒ 1 – 30 rpm Gear 368:1 ⇒ 1 – 15 rpm

Sub-index	06 <sub>h</sub>
Description	a – Rot (acceleration velocity mode) (see chapter 8: <a href="#">Parameter description</a> ⇒ <a href="#">Parameter no. 6</a> )
Access	read-write (recordable in the "Pre-Operational" and "Operational" states, cannot be written with active travel job)
PDO mapping	no
Data type	Unsigned8
Default	50
EEPROM	yes
Value range	1 ... 100

Sub-index	08 <sub>h</sub>
Description	a – Inch (acceleration inching operation) (see chapter 8: <a href="#">Parameter description</a> ⇒ <a href="#">Parameter no. 8</a> )
Access	read-write (recordable in the "Pre-Operational" and "Operational" states, cannot be written with active travel job)
PDO mapping	no
Data type	Unsigned8
Default	50
EEPROM	yes
Value range	1 ... 100

Sub-index	09 <sub>h</sub>
Description	v – Inch (velocity inching operation (see chapter 8: <a href="#">Parameter description</a> ⇒ <a href="#">Parameter no. 9</a> ))
Access	read-write (recordable in the "Pre-Operational" and "Operational" states, cannot be written with active travel job)
PDO mapping	no
Data type	Unsigned8
Default	10
EEPROM	yes
Value range	Gear 66:1 ⇒ 1 – 75 rpm Gear 98:1 ⇒ 1 – 50 rpm Gear 188:1 ⇒ 1 – 30 rpm Gear 368:1 ⇒ 1 – 15 rpm

**9.13.2.37 2412<sub>h</sub>: Spindle Pitch**

Spindle pitch is set via object 2412<sub>h</sub>.

Sub-index	00 <sub>h</sub>
Description	Spindle pitch (see chapter 8: <a href="#">Parameter description</a> ⇒ <a href="#">Parameter no. 13</a> )
Access	read-write (recordable in the "Pre-Operational" and "Operational" states, cannot be written with active travel job)
PDO mapping	no
Data type	Unsigned32
Default	0
EEPROM	yes
Value range	1 ... 1000000

**9.13.2.38 2413<sub>h</sub>: Pos Type**

The positioning type is set via object 2413<sub>h</sub>.

Sub-index	00 <sub>h</sub>
Description	Positioning type (see chapter 8: <a href="#">Parameter description</a> ⇒ <a href="#">Parameter no. 19</a> )
Access	read-write (recordable in the "Pre-Operational" and "Operational" states, cannot be written with active travel job)
PDO mapping	no
Data type	Unsigned32
Default	0
EEPROM	yes
Value range	0 ... 2

**Data description:**

Value = 0: direct  
 Value = 1: loop +  
 Value = 2: loop -



**9.13.2.39 2415<sub>h</sub>: Delta Jog**

The travel distance in inching operation 1 is set via object 2415<sub>h</sub>.

Sub-index	00 <sub>h</sub>
Description	Travel distance inching operation 1 (see chapter 8: <a href="#">Parameter description</a> ⇒ <a href="#">Parameter no. 17</a> )
Access	read-write (recordable in the "Pre-Operational" and "Operational" states, cannot be written with active travel job)
PDO mapping	no
Data type	Integer32
Default	720
EEPROM	yes
Value range	-1000000 ... +1000000

**9.13.2.40 2416<sub>h</sub>: Stop Mode Inching Mode 2**

The stop behaviour in inching mode 2 is set via object 2416<sub>h</sub>.

Sub-index	00 <sub>h</sub>
Description	stop mode inching 2 (see chapter 8: <a href="#">Parameter description</a> ⇒ <a href="#">Parameter no. 25</a> )
Access	read-write (recordable in the "Pre-Operational" and "Operational" states, cannot be written with active travel job)
PDO mapping	no
Data type	Unsigned32
Default	0
EEPROM	yes
Value range	0 ... 1

**9.13.2.41 2417<sub>h</sub>: Inpos Mode**

The drive's behaviour when reaching the positioning window is defined by object 2417<sub>h</sub>.

Sub-index	00 <sub>h</sub>
Description	Inpos Mode (see chapter 8: <a href="#">Parameter description</a> ⇒ <a href="#">Parameter no. 26</a> )
Access	read-write (recordable in the "Pre-Operational" and "Operational" states, cannot be written with active travel job)
PDO mapping	no
Data type	Unsigned8
Default	0
EEPROM	yes
Value range	0 ... 2

**9.13.2.42 2418<sub>h</sub>: Loop Length**

Loop length is determined by object 2418<sub>h</sub>.

Sub-index	00 <sub>h</sub>
Description	Loop Length (see chapter 8: <a href="#">Parameter description</a> ⇒ <a href="#">Parameter no. 27</a> )
Access	read-write (recordable in the "Pre-Operational" and "Operational" states, cannot be written with active travel job)
PDO mapping	no
Data type	Unsigned16
Default	360
EEPROM	yes
Value range	0 ... 30000

**9.13.2.43 2419<sub>h</sub>: Contouring Error Limit**

The contouring error limit can be set via object 2419<sub>h</sub>.

Sub-index	00 <sub>h</sub>
Description	Contouring error limit (see chapter 8: <a href="#">Parameter description</a> ⇒ <a href="#">Parameter no. 28</a> )
Access	read-write (recordable in the "Pre-Operational" and "Operational" states, cannot be written with active travel job)
PDO mapping	no
Data type	Unsigned16
Default	400
EEPROM	yes
Value range	1 ... 30000

**9.13.2.44 241A<sub>h</sub>: Contouring Error**

The current contouring error can be read via object 241A<sub>h</sub>.

Sub-index	00 <sub>h</sub>
Description	Current contouring error
Access	read-only
PDO mapping	no
Data type	Integer16
Default	no
EEPROM	no

**9.13.2.45 241B<sub>n</sub>: Power Supply Voltage**

Object 241B<sub>n</sub> contains the supply voltages.

Sub-index	00 <sub>n</sub>
Description	largest sub-index supported
Access	read-only
PDO mapping	no
Data type	Unsigned8
Default	2
EEPROM	no

Sub-index	01 <sub>n</sub>
Description	Output stage supply voltage (see chapter 8: <a href="#">Parameter description</a> ⇒ <a href="#">Parameter no. 52</a> )
Access	read-only
PDO mapping	no
Data type	Unsigned16
Default	no
EEPROM	no

Sub-index	02 <sub>n</sub>
Description	Control supply voltage (see chapter 8: <a href="#">Parameter description</a> ⇒ <a href="#">Parameter no. 51</a> )
Access	read-only
PDO mapping	no
Data type	Unsigned16
Default	no
EEPROM	no

**9.13.2.46 241C<sub>n</sub>: Output Stage Temperature**

Object 241C<sub>n</sub> contains the output stage temperature.

Sub-index	00 <sub>n</sub>
Description	Output stage temperature (see chapter 8: <a href="#">Parameter description</a> ⇒ <a href="#">Parameter no. 50</a> )
Access	read-only
PDO mapping	no
Data type	Integer16
Default	no
EEPROM	no

**9.13.2.47 241E<sub>n</sub>: Motor Current**

Object 241E<sub>n</sub> contains the actual motor current.

Sub-index	00 <sub>n</sub>
Description	Motor current (see chapter 8: <a href="#">Parameter description</a> ⇒ <a href="#">Parameter no. 54</a> )
Access	read-only
PDO mapping	no
Data type	Integer16
Default	no
EEPROM	no

**9.13.2.48 2421<sub>n</sub>: Motor Current Limit**

Motor current limitation is set via object 2421<sub>n</sub>.

Sub-index	00 <sub>n</sub>
Description	Motor current limitation (see chapter 8: <a href="#">Parameter description</a> ⇒ <a href="#">Parameter no. 29</a> )
Access	read-write (recordable in the "Pre-Operational" and "Operational" states, cannot be written with active travel job)
PDO mapping	no
Data type	Unsigned8
Default	110
EEPROM	yes
Value range	25 ... 110

**9.13.2.49 2423<sub>n</sub>: Battery Voltage**

Object 2423<sub>n</sub> contains the current battery voltage.

Sub-index	00 <sub>n</sub>
Description	Battery voltage (see chapter 8: <a href="#">Parameter description</a> ⇒ <a href="#">Parameter no. 53</a> )
Access	read-only
PDO mapping	no
Data type	Integer16
Default	no
EEPROM	no

**9.13.2.50 2424<sub>n</sub>: Motor Thermal Load**

Object 2424<sub>n</sub> contains the thermal load of the motor.

Subindex	00 <sub>n</sub>
Description	Motor thermal load (see chapter 8: <a href="#">Parameter description</a> ⇒ <a href="#">Parameter no. 75</a> )
Access	read-only
PDO-Mapping	no
Data type	Unsigned8
Default	no
EEPROM	no

**9.13.2.51 2450<sub>n</sub>: Inching 2 Offset**

An offset value can be set in inching operation 2 via object 2450<sub>n</sub>.

Sub-index	00 <sub>n</sub>
Description	Offset value in inching operation 2 (see chapter 8: <a href="#">Parameter description</a> ⇒ <a href="#">Parameter no. 30</a> )
Access	read-write (recordable in the "Pre-Operational" and "Operational" states)
PDO mapping	no
Data type	Unsigned8
Default	100
EEPROM	no
Value range	10 ... 100

**9.13.2.52 2451<sub>n</sub>: Type of acceleration Inching mode 2**

The type of acceleration can be set in inching operation 2 via object 2451<sub>n</sub>.

Sub-index	00 <sub>n</sub>
Description	Type of acceleration in inching operation 2 (see chapter 8: <a href="#">Parameter description</a> ⇒ <a href="#">Parameter no. 31</a> )
Access	read-write (recordable in the "Pre-Operational" and "Operational" states, cannot be written with active travel job)
PDO mapping	no
Data type	Unsigned8
Default	0
EEPROM	yes
Value range	0 ... 1

**9.13.2.53 2500<sub>n</sub>: Production Date**

Object 2500<sub>n</sub> indicates the production date.

Sub-index	00 <sub>n</sub>
Description	date of production in readable hex notation (see chapter 8: <a href="#">Parameter description</a> ⇒ <a href="#">Parameter no. 58</a> )
Access	read-only
PDO mapping	no
Data type	Unsigned32
Default	no
EEPROM	yes

**Format description (example):**

15 07 20 09<sub>n</sub> = 15.07.2009 = DDMMJJJJ

**9.13.2.54 2501<sub>n</sub>: Display Software Version**

Object 2501<sub>n</sub> indicates the software version of the display controller firmware.

Sub-index	00 <sub>n</sub>
Description	Software version in ASCII characters
Access	const
PDO mapping	no
Data type	Visible String
Default	no
EEPROM	no

**Format description (example):**

Bit 7 - 0	31 <sub>n</sub> = ' 1 ' (ASCII character, ISO 8859)
Bit 15 - 8	2E <sub>n</sub> = ' . ' (ASCII character, ISO 8859)
Bit 23 - 16	30 <sub>n</sub> = ' 0 ' (ASCII character, ISO 8859)
Bit 31 - 24	30 <sub>n</sub> = ' 0 ' (ASCII character, ISO 8859)

Software version = V 1.00

**9.13.2.55 2900<sub>n</sub>: Error Counters**

Object 2900h contains error counters. These cannot be deleted.

Sub-index	00 <sub>n</sub>
Description	largest supported sub-index
Access	ro
PDO mapping	no
Data type	Unsigned8

Default	24
EEPROM	no

(see chapter 8: [Parameter description](#) ⇒ from [Parameter no. 76](#))

Sub-index	Data type	Description
01 <sub>h</sub>	Unsigned8	Timeout client
02 <sub>h</sub>	Unsigned8	Timeout host
03 <sub>h</sub>	Unsigned8	Checksum client
04 <sub>h</sub>	Unsigned8	Checksum host
05 <sub>h</sub>	Unsigned8	Define mismatch
06 <sub>h</sub>	Unsigned8	Battery undervoltage
07 <sub>h</sub>	Unsigned8	Control undervoltage
08 <sub>h</sub>	Unsigned8	Control overvoltage
09 <sub>h</sub>	Unsigned8	Power overvoltage
0A <sub>h</sub>	Unsigned8	Overtemperature
0B <sub>h</sub>	Unsigned8	Lag
0C <sub>h</sub>	Unsigned8	Shaft blocked
0D <sub>h</sub>	Unsigned8	SinCos error
0E <sub>h</sub>	Unsigned8	Queue 1 overrun
0F <sub>h</sub>	Unsigned8	Queue 2 overrun
10 <sub>h</sub>	Unsigned8	Checksum EEPROM
11 <sub>h</sub>	Unsigned8	Error passive on move
12 <sub>h</sub>	Unsigned8	Bus off
13 <sub>h</sub>	Unsigned8	Queue 3 overrun
14 <sub>h</sub>	Unsigned8	Queue 4 overrun
15 <sub>h</sub>	Unsigned8	Can overrun
16 <sub>h</sub>	Unsigned8	Motor overcurrent
17 <sub>h</sub>	Unsigned8	PID loop unstable
18 <sub>h</sub>	Unsigned8	Motor thermal overload

### 9.13.2.56 6040<sub>h</sub>: Control word

The object 6040<sub>h</sub> is the control word of the state machine for drives according to the device profile CiA DSP-402.

Sub-index	00 <sub>h</sub>
Description	control word
Access	read-write (recordable in the "Pre-Operational" and "Operational" states)
PDO mapping	yes
Data type	Unsigned16
Default	no
EEPROM	no

**9.13.2.57 6041<sub>h</sub>: Status word**

The object 6041<sub>h</sub> is the status word of the state machine for drives according to the device profile CiA DSP-402.

Sub-index	00 <sub>h</sub>
Description	Status word
Access	read-only
PDO mapping	yes
Data type	Unsigned16
Default	no
EEPROM	no

**Format description:**

See chapter 9.5: [Status word](#)

**PDO mapping:**

The status word is mapped on the three Transmit PDOs (see objects 1A00<sub>h</sub> – 1A03<sub>h</sub>).

**9.13.2.58 6060<sub>h</sub>: Modes of Operation**

The operation mode of the actuator is set via object 6060<sub>h</sub>.

Sub-index	00 <sub>h</sub>
Description	Operating mode (see chapter 8: <a href="#">Parameter description</a> ⇒ <a href="#">Parameter no. 20</a> )
Access	read-write (recordable in the "Pre-Operational" and "Operational" states, cannot be written with active travel job)
PDO mapping	no
Data type	Integer8
Default	1
EEPROM	yes
Value range	1 ... 2

**Data description:**

Value = 1: Profile Position Mode (positioning mode)

Value = 2: Profile Velocity Mode (velocity mode)



**9.13.2.59 6061<sub>n</sub>: Modes of Operation Display**

The operating mode set can be read via object 6061<sub>n</sub>.

Sub-index	00 <sub>n</sub>
Description	Operating mode (see chapter 8: <a href="#">Parameter description</a> ⇒ <a href="#">Parameter no. 20</a> )
Access	read-only
PDO mapping	no
Data type	Integer8
Default	no
EEPROM	no

**Data description:**

Value = 1: Profile Position Mode (positioning mode)  
 Value = 2: Profile Velocity Mode (velocity mode)

**9.13.2.60 6064<sub>n</sub>: Position Actual Value**

Object 6064<sub>n</sub> contains the actual position value in the Profile Position Mode (positioning mode).

Sub-index	00 <sub>n</sub>
Description	absolute position value in the positioning mode
Access	read-only
PDO mapping	yes
Data type	Integer32
Default	no
EEPROM	no

**PDO mapping:**

The absolute position value and the status word of the state machine are mapped on the Transmit PDO3, see object 1A02<sub>n</sub> (3<sup>rd</sup> Transmit PDO mapping parameter).

**9.13.2.61 6067<sub>h</sub>: Position Window**

A symmetric range of tolerable positions for standstill monitoring in the target point of positioning is set via object 6067<sub>h</sub>.

Sub-index	00 <sub>h</sub>
Description	Pos- window (see chapter 8: <a href="#">Parameter description</a> ⇒ <a href="#">Parameter no. 10</a> )
Access	read-write (recordable in the "Pre-Operational" and "Operational" states, cannot be written with active travel job)
PDO mapping	no
Data type	Unsigned32
Default	10
EEPROM	yes
Value range	0 ... 1000

**9.13.2.62 606C<sub>h</sub>: Velocity Actual Value**

Object 606C<sub>h</sub> contains the actual velocity in the Profile Velocity Mode (velocity mode).

Sub-index	00 <sub>h</sub>
Description	Actual velocity in velocity mode
Access	read-only
PDO mapping	yes
Data type	Integer32
Default	no
EEPROM	no

**PDO mapping:**

The actual velocity and the status word of the state machine are mapped on the Transmit PDO4, see object 1A03<sub>h</sub> (4<sup>th</sup> Transmit PDO mapping parameter).

**9.13.2.63 607A<sub>h</sub>: Target Position**

The target position of a drive movement in the operation mode Profile Position Mode (position mode) is entered via object 607A<sub>h</sub>.

Sub-index	00 <sub>h</sub>
Description	setpoint in the positioning mode
Access	read-write (recordable in the "Pre-Operational" and "Operational" states, cannot be written with active travel job)
PDO mapping	yes
Data type	Integer32
Default	no
EEPROM	no
Value range	±9999999

**PDO mapping:**

The target position and the control word of the state machine are mapped on the Receive PDO3, see object 1602<sub>h</sub> (3<sup>rd</sup> Receive PDO mapping parameter).

**9.13.2.64 607C<sub>h</sub>: Calibration Value**

The calibration value is programmed and the programmed calibration value taken over as the absolute position value via object 607C<sub>h</sub>.

Sub-index	00 <sub>h</sub>
Description	Calibration value (see chapter 8: <a href="#">Parameter description</a> ⇒ <a href="#">Parameter no. 14</a> and chapter 5: <a href="#">Calibration</a> )
Access	read-write (recordable in the "Pre-Operational" and "Operational" states, cannot be written with active travel job)
PDO mapping	no
Data type	Integer32
Default	0
EEPROM	yes
Value range	±999999

**9.13.2.65 607D<sub>h</sub>: Software Position Limit**

Via object 607D<sub>h</sub>, the software limit switches defining the working range of the drive are set.

Sub-index	00 <sub>h</sub>
Description	Number of subindexes
Access	read-only
PDO mapping	no
Data type	Unsigned8
Default	2
EEPROM	no

Sub-index	01 <sub>h</sub>
Description	Limit 2 (see chapter 8: <a href="#">Parameter description</a> ⇒ <a href="#">Parameter no. 16</a> )
Access	read-write (recordable in the "Pre-Operational" and "Operational" states, cannot be written with active travel job)
PDO mapping	no
Data type	Integer32
Default	-19999
EEPROM	yes
Value range	±9999999

Sub-index	02 <sub>n</sub>
Description	Limit 1 (see chapter 8: <a href="#">Parameter description</a> ⇒ <a href="#">Parameter no. 15</a> )
Access	read-write (recordable in the "Pre-Operational" and "Operational" states, cannot be written with active travel job)
PDO mapping	no
Data type	Integer32
Default	99999
EEPROM	yes
Value range	±9999999

### 9.13.2.66 607E<sub>n</sub>: Polarity

The polarity of the drive's sense of rotation is set via object 607E<sub>n</sub>.

Sub-index	00 <sub>n</sub>
Description	Sense of rotation (see chapter 8: <a href="#">Parameter description</a> ⇒ <a href="#">Parameter no. 18</a> )
Access	read-write (recordable in the "Pre-Operational" and "Operational" states, cannot be written with active travel job)
PDO mapping	no
Data type	Unsigned8
Default	0
EEPROM	yes
Value range	0 ... 1

#### Data description:

Value '0' = sense of rotation 'i'.  
 Value '1' = sense of rotation 'e'.

### 9.13.2.67 6091<sub>n</sub>: Gear Ratio

A gear ratio can be programmed via object 6091<sub>n</sub>.

Sub-index	00 <sub>n</sub>
Description	Number of subindexes
Access	read-only
PDO mapping	no
Data type	Unsigned8
Default	2
EEPROM	no

Sub-index	01 <sub>h</sub>
Description	Numerator gear ratio (see chapter 8: <a href="#">Parameter description</a> ⇒ <a href="#">Parameter no. 11</a> )
Access	read-write (recordable in the "Pre-Operational" and "Operational" states, cannot be written with active travel job)
PDO mapping	no
Data type	Unsigned32
Default	1
EEPROM	yes
Value range	1 ... 10000

Sub-index	02 <sub>h</sub>
Description	Denominator gear ratio (see chapter 8: <a href="#">Parameter description</a> ⇒ <a href="#">Parameter no. 12</a> )
Access	read-write (recordable in the "Pre-Operational" and "Operational" states, cannot be written with active travel job)
PDO mapping	no
Data type	Unsigned32
Default	1
EEPROM	yes
Value range	1 ... 10000

See also chapter 6: [External gear](#).

### 9.13.2.68 60FF<sub>h</sub>: Target Velocity

The target velocity of a drive movement in the operation mode Profile Velocity Mode (velocity mode) is entered via object 60FF<sub>h</sub>.

Sub-index	00 <sub>h</sub>
Description	Target velocity in the velocity mode of operation
Access	read-write (recordable in the "Pre-Operational" and "Operational" states)
PDO mapping	yes
Data type	Integer32
Default	no
EEPROM	no
Value range	Gear 66:1 ⇒ ±75 rpm Gear 98:1 ⇒ ±50 rpm Gear 188:1 ⇒ ±30 rpm Gear 368:1 ⇒ ±15 rpm

#### PDO mapping:

The target velocity and the control word of the state machine are mapped on the Receive PDO4, see object 1603<sub>h</sub> (4<sup>th</sup> Receive PDO mapping parameter).