

# AG24

Actuator with **EtherNet/IP™** interface

User manual



## Table of contents

<b>1</b>	<b>General Information .....</b>	<b>8</b>
1.1	Documentation .....	8
1.1.1	History .....	8
<b>2</b>	<b>Display and control keys .....</b>	<b>8</b>
2.1	LCD display.....	9
2.2	LED display.....	9
2.2.1	Status LED 1.....	9
2.2.2	Status LED 2.....	9
2.2.3	Network status LED 4.....	9
2.2.4	Link/Activity LED 5, 6.....	10
2.2.5	Module status LED 7 .....	10
2.3	Control keys.....	10
2.3.1	Key lock and enable time .....	11
2.3.2	Value input .....	11
2.3.3	Value selection .....	11
2.4	Menu control .....	12
2.4.1	Menu selection .....	12
2.4.2	Changeable parameters menu.....	13
2.4.2.1	PCM menu .....	13
2.4.3	Readable parameters menu .....	13
2.4.4	Error memory menu .....	14
<b>3</b>	<b>Functional description .....</b>	<b>14</b>
3.1	User units .....	14
3.1.1	Example of spindle drive .....	15
3.1.2	Example of toothed rod/pinion, straight toothing, metric division .....	15
3.1.3	Example external gear.....	15
3.2	Protective functions.....	16
3.2.1	Current limiting .....	16
3.2.2	I2t monitoring.....	17
3.2.3	Temperature monitoring.....	17
3.2.4	Overvoltage protection with energetic recovery .....	17
3.2.5	Contouring error monitoring .....	17
3.3	Warnings / Errors.....	18
3.3.1	Warnings .....	18
3.3.2	Errors .....	18
3.3.2.1	Error codes .....	18
3.4	Operating modes .....	19
3.4.1	Positioning mode.....	19
3.4.1.1	Limiting values .....	20
3.4.1.2	Limit switch.....	21
3.4.1.2.1	Example of a configuration.....	21

3.4.1.2.2	Assembly of the limit switches.....	22
3.4.1.3	Loop positioning .....	22
3.4.1.4	Inching operation.....	23
3.4.1.4.1	Inching operation 1 .....	23
3.4.1.4.2	Inching operation 2 .....	24
3.4.1.5	Travel Against Load .....	24
3.4.1.6	Control word: Positioning mode (master ⇒ slave).....	25
3.4.1.7	Status word: Positioning mode (slave ⇒ master) .....	26
3.4.1.8	Flow chart: Operating mode Positioning mode .....	27
3.4.2	Local control (Stand-Alone Operation) .....	28
3.4.2.1	Inching operation 2.....	28
3.4.2.2	Specifying the set point .....	28
3.4.3	Digital inputs and outputs.....	29
3.4.3.1	Examples of digital input configurations .....	30
3.4.3.2	Example of digital output configuration.....	31
3.4.4	Position Control Mode.....	31
3.4.4.1	Examples of configuration of the digital inputs for the PCM.....	32
3.4.5	Calibration .....	33
3.4.6	Sense of Rotation .....	34
3.4.7	Rotational speed mode .....	34
3.4.7.1	Control word Operating mode: Speed mode.....	35
3.4.7.2	Status word Operating mode: Speed mode .....	36
3.4.7.3	Flow chart: Operating mode Speed mode.....	37
<b>4</b>	<b>EtherNet/IP™ .....</b>	<b>38</b>
4.1	Description.....	38
4.1.1	IP-Configuration .....	38
4.1.2	I/O Messages.....	40
4.1.3	Explicit Messages .....	40
4.1.4	ADI Object (Class A2h).....	40
4.2	CIP objects.....	41
4.2.1	Identity Object (Class 01h).....	42
4.2.1.1	Class attributes of the Identity Object.....	42
4.2.1.2	Instance attributes of the Identity Object.....	42
4.2.1.3	Status.....	43
4.2.1.4	Reset service of the Identity Object .....	44
4.3	Commissioning aids .....	44
<b>5</b>	<b>Parameters.....</b>	<b>44</b>
5.1	Positioning.....	45
5.1.1	Sense of Rotation .....	45
5.1.2	Spindle Pitch.....	45
5.1.3	Gear Ratio Numerator .....	46
5.1.4	Gear Ratio Denominator .....	47
5.1.5	Pos Window.....	47

5.1.6	Offset Value .....	48
5.1.7	Delta Inch.....	48
5.1.8	Inpos Mode .....	49
5.1.9	Pos Type.....	50
5.1.10	Loop Length.....	50
5.1.11	Calibration Value.....	51
5.1.12	Control Word .....	51
5.1.13	Status Word .....	52
5.1.14	Target Value.....	53
5.1.15	Actual Value.....	53
5.1.16	System Status Word.....	54
5.2	Actuator.....	56
5.2.1	Operating Mode .....	56
5.2.2	A-Pos .....	57
5.2.3	V-Pos .....	57
5.2.4	D-Pos .....	58
5.2.5	A-Inch.....	59
5.2.6	V-Inch.....	59
5.2.7	Inching 2 Offset .....	60
5.2.8	A-Rot .....	60
5.3	Limiting values .....	61
5.3.1	Software Limit 1 .....	61
5.3.2	Software Limit 2 .....	62
5.3.3	Peak Current Limit.....	62
5.3.4	Peak Current Time .....	63
5.3.5	Continuous Current.....	63
5.3.6	Contouring Error Limit .....	64
5.3.7	Travel Against Load Trigger .....	64
5.3.8	Travel Against Load Direction .....	65
5.4	Visualization.....	66
5.4.1	Display Orientation .....	66
5.4.2	Display Divisor.....	66
5.4.3	Display Divisor Application .....	67
5.4.4	Decimal Places.....	67
5.4.5	Direction Indication Function .....	68
5.4.6	Displayed Value 2nd Line .....	69
5.5	Options.....	70
5.5.1	Key Enable Time.....	70
5.5.2	Key Function Enable .....	70
5.5.3	Inching 2 Acceleration Type .....	71
5.5.4	Inching 2 Stop Mode .....	72
5.5.5	PIN Change .....	72
5.5.6	Generic Mapping Parameter .....	73
5.5.7	Configuration .....	74

5.5.8	S-Command .....	75
5.6	Controller parameter .....	76
5.6.1	Controller Parameter P .....	76
5.6.2	Controller Parameter I .....	76
5.6.3	Controller Parameter D .....	77
5.7	Digital input/output .....	78
5.7.1	Digital Input 1 Functionality .....	78
5.7.2	Digital Input 2 Functionality .....	79
5.7.3	Digital Input 3 Functionality .....	79
5.7.4	Digital Input 4 Functionality .....	80
5.7.5	Digital Inputs Polarity .....	81
5.7.6	Digital Input Functionalities State .....	81
5.7.7	Digital Inputs State .....	82
5.7.8	Digital Output 1 Functionality .....	83
5.7.9	Digital Outputs Polarity .....	84
5.7.10	Digital Output Functionalities State .....	84
5.7.11	Digital Outputs Control .....	85
5.7.12	Service Interface Baud Rate .....	86
5.8	Position Control Mode .....	87
5.8.1	PCM Position 1 .....	87
5.8.2	PCM Position 2 .....	87
5.8.3	PCM Position 3 .....	88
5.8.4	PCM Position 4 .....	88
5.8.5	PCM Position 5 .....	89
5.8.6	PCM Position 6 .....	89
5.8.7	PCM Position 7 .....	90
5.8.8	PCM Acceleration 1 .....	91
5.8.9	PCM Acceleration 2 .....	91
5.8.10	PCM Acceleration 3 .....	92
5.8.11	PCM Acceleration 4 .....	92
5.8.12	PCM Acceleration 5 .....	93
5.8.13	PCM Acceleration 6 .....	93
5.8.14	PCM Acceleration 7 .....	94
5.8.15	PCM Velocity 1 .....	95
5.8.16	PCM Velocity 2 .....	95
5.8.17	PCM Velocity 3 .....	96
5.8.18	PCM Velocity 4 .....	96
5.8.19	PCM Velocity 5 .....	97
5.8.20	PCM Velocity 6 .....	98
5.8.21	PCM Velocity 7 .....	98
5.8.22	PCM Deceleration 1 .....	99
5.8.23	PCM Deceleration 2 .....	99
5.8.24	PCM Deceleration 3 .....	100
5.8.25	PCM Deceleration 4 .....	100

5.8.26	PCM Deceleration 5 .....	101
5.8.27	PCM Deceleration 6 .....	102
5.8.28	PCM Deceleration 7 .....	102
5.9	Device information .....	103
5.9.1	Output Stage Temperature .....	103
5.9.2	Virtual Motor Temperature .....	103
5.9.3	Voltage of Control .....	104
5.9.4	Voltage of Output Stage .....	105
5.9.5	Motor Current .....	105
5.9.6	Actual Position .....	106
5.9.7	Actual Rotational Speed .....	106
5.9.8	Overload .....	107
5.9.9	Actual Contouring Error .....	107
5.9.10	Gear Reduction .....	108
5.9.11	Encoder Resolution .....	109
5.9.12	Serial Number .....	109
5.9.13	SW Motor Controller .....	110
5.9.14	SW Ethernet Module .....	110
5.9.15	Production Date .....	111
5.9.16	Device ID .....	111
5.9.17	Generic Mapping Channel .....	112
5.10	Error memory .....	113
5.10.1	Number of Errors .....	113
5.10.2	Error Number 1 .....	113
5.10.3	Error Number 2 .....	114
5.10.4	Error Number 3 .....	114
5.10.5	Error Number 4 .....	115
5.10.6	Error Number 5 .....	116
5.10.7	Error Number 6 .....	116
5.10.8	Error Number 7 .....	117
5.10.9	Error Number 8 .....	117
5.10.10	Error Number 9 .....	118
5.10.11	Error Number 10 .....	118
<b>6</b>	<b>Service protocol.....</b>	<b>119</b>
6.1	General Information.....	119
6.1.1	Communication.....	119
6.1.2	Settings.....	119
6.1.3	ASCII commands.....	119
6.1.4	Responses .....	120
6.2	Commands.....	120
6.2.1	Start travel job .....	120
6.2.2	Start of inching mode1 .....	120
6.2.3	Start inching mode 2 positive travel direction .....	120

6.2.4	Start inching mode 2 negative travel direction .....	120
6.2.5	Cancel current travel job in positioning mode .....	120
6.2.6	Motor stop fast.....	121
6.2.7	Motor stop .....	121
6.2.8	Activate motor .....	121
6.2.9	Factory setting: all parameters.....	121
6.2.10	Factory setting: Standard parameter .....	121
6.2.11	Factory setting: Controller parameter .....	121
6.2.12	Factory setting: Visualization parameters.....	122
6.2.13	Factory setting: Network parameters .....	122
6.2.14	Acknowledge error.....	122
6.2.15	Calibrate.....	122
6.2.16	Delete error memory .....	122
6.2.17	Software reset .....	122
6.3	Flow charts.....	123
6.3.1	Flow chart: Operating mode: Positioning mode.....	123
6.3.2	Flow chart: Operating mode: Speed mode .....	124
6.4	Error number encoding .....	124
6.5	Examples.....	125
6.5.1	Write and read set point +500.....	125
6.5.2	Start travel job .....	125
6.6	ASCII command structure .....	125
6.7	Commissioning aids .....	126
<b>7</b>	<b>Ethernet Functions .....</b>	<b>127</b>
7.1	Web server.....	127
7.2	FTP-Server .....	128
7.3	Secure Host IP Configuration Protocol (Secure HICP) .....	128
<b>8</b>	<b>Block diagram .....</b>	<b>129</b>

## 1 General Information

### 1.1 Documentation

The following documents are associated with this document:



- The data sheet describes the technical data, the dimensions, the pin assignment, the accessories and the order key.
- The installation instructions describe the mechanical and electrical installation with all safety-relevant conditions and the associated technical specifications.
- User manual describing the migration of the actuator into an Industrial Ethernet network and its commissioning.

You can also download these documents at <http://www.siko-global.com/p/ag24>.

#### 1.1.1 History

Mod. status	Date	Description
155/22	25.08.2022	from firmware V1.14 Chapter <a href="#">1.1.1 History</a> new Chapter <a href="#">7.3 Secure Host IP Configuration Protocol (Secure HICP)</a> add text

## 2 Display and control keys

The actuator features a two-line display ③ with special characters and three operating keys , , and .

The actuator can be configured and controlled via the keys.

The two LEDs ① and ② inform about the operating status of the actuator.

The four LEDs ④, ⑤, ⑥, and ⑦ inform about the operating status of the Ethernet module.

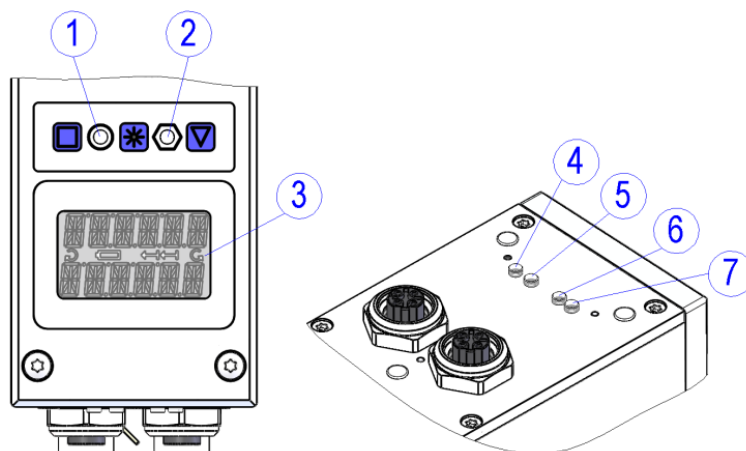

Fig. 1: Display and control elements



## 2.1 LCD display

With operating voltage applied to the control unit, the actual value is displayed in the 1<sup>st</sup> line and the target value is displayed in the 2<sup>nd</sup> line (factory setting). The value displayed in the 2<sup>nd</sup> line can be chosen by means of parameter setting (see chapter 5.4.6). In the positioning mode, the direction indicators in the display indicate the key to be pressed for the inching mode to get to the set positioning window (see chapter 5.4.5). For signaling the speed mode, both direction indicators are activated in the display.

## 2.2 LED display

### 2.2.1 Status LED 1

<b>NOTICE</b>	If the actual value is unequal after switching on the module and if it is outside the programmed positioning window, then the LED status is "red" or "red, flashing" due to volatile storage of the set point. The set point is initialized with the value 0 after switching on.
---------------	--

LED state	Description
green	Actuator is within the programmed positioning window. Operating voltage of the output stage is applied.
green, flashing	Actuator is within the programmed position window. Operating voltage of the output stage missing.
red	Actuator is outside the programmed positioning window. Operating voltage of the output stage is applied.
red, flashing	Actuator is outside the programmed positioning window. Operating voltage of the output stage missing.
off	Operating voltage of control missing.

### 2.2.2 Status LED 2

LED state	Description
green	Operating voltage applied to control, no fault.
red, flashing	Operating voltage applied to control, active fault.
flashing red/green	Operating voltage of control is applied, switch lock active.
off	Operating voltage of control missing.

### 2.2.3 Network status LED 4

<b>NOTICE</b>	A test sequence is executed on this LED after switching on the device.
---------------	--

LED state	Description
off	No operating voltage or no IP address.
green	On-line, one or multiple connections established (CIP Class 1 or 3).
green, flashing	On-line, no connection established.
red	Double IP address, fatal error.
red, flashing	On-line, one or multiple connections timeout (CIP Class 1 or 3).

#### 2.2.4 Link/Activity LED 5, 6

LED state	Description
off	no connection, no activity
green	connection (100 Mbit/s) established
green, flickers	activity (100 Mbit/s)
yellow	connection (10 Mbit/s) established
yellow, flickers	activity (10 Mbit/s)

#### 2.2.5 Module status LED 7

<b>NOTICE</b>	A test sequence is executed on this LED after switching on the device.
---------------	--

LED state	Description
off	no operating voltage
green	control via scanner
green, flashing	not configured or scanner inactive
red	serious error
red, flashing	Correctable error. The module has been configured but the stored parameters differ from the parameters presently used.

### 2.3 Control keys

After applying operating voltage to the control, the actuator will be on the highest level of the menu structure, the positioning mode will be active (factory setting).

Pressing the  - key starts leftward travel (inching operation 2).

Pressing the  - key starts rightward travel (inching operation 2).

Releasing the respective key stops travel movement.



Pressing the  - key starts the parameter / programming mode.

### 2.3.1 Key lock and enable time

The access via keys to the functions of Inching mode 2, positioning mode and speed mode can be generally locked via the Key Function Enable parameter (see chapter 5.5.2). Temporary locking or enabling is possible via the control word Bit 9. The Key Enable Time parameter (see chapter 5.5.1) defines the necessary period of holding down the asterisk key until you get to the menu or until the set point setting via the display is enabled, respectively.

### 2.3.2 Value input

<b>NOTICE</b>	When you enter values via the keys, the display range is limited to -199999 ... 999999. If values beyond this range are entered via the network or service protocol, "FULL" will be displayed when the parameter is called up.
---------------	--



Enter values via the  key and the  key.  
Confirm values entered by pressing the  key.

 key: decimal place selection

 key: value input

### 2.3.3 Value selection

For some parameters you can select values from a list. Direct value input is not possible there.

Pressing the  key, the value can be selected from the list. By pressing the  key, the selection is confirmed.

## 2.4 Menu control

### 2.4.1 Menu selection

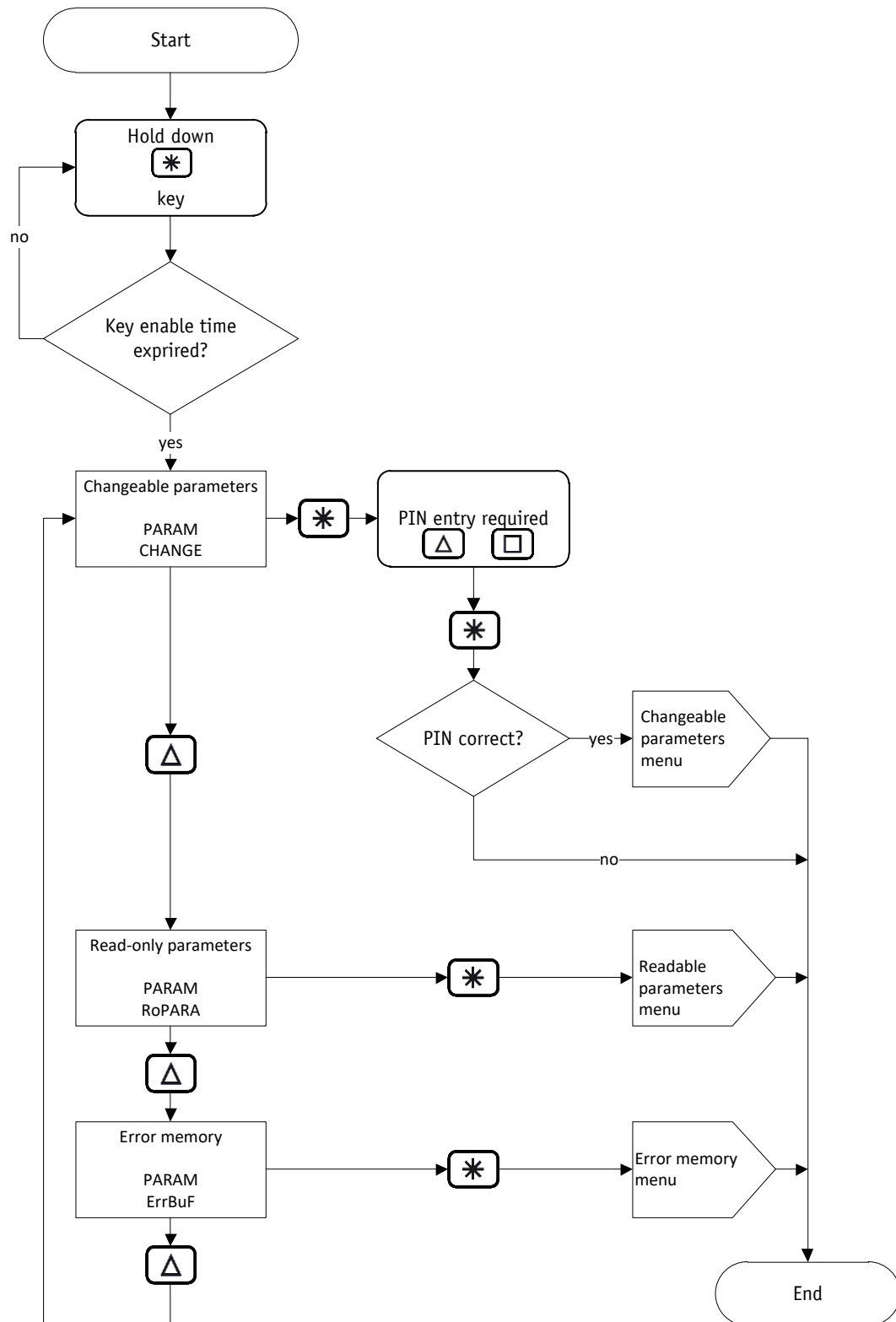

Fig. 2: Menu selection

## 2.4.2 Changeable parameters menu

The changeable parameters menu is structured as follows:

Description	Display	Page
EtherNet/IP	EIP	<a href="#">38</a>
Positioning	POSIT	<a href="#">45</a>
Actuator	DRIVE	<a href="#">56</a>
Limiting values	BOUNDS	<a href="#">61</a>
Visualization	VISUAL	<a href="#">66</a>
Options	OPTION	<a href="#">70</a>
Controller parameter	CONTR	<a href="#">76</a>
Digital input/output	DIG IO	<a href="#">77</a>
Position Control Mode	PCM	<a href="#">87</a>

### 2.4.2.1 PCM menu

The PCM menu is divided into single sets of parameters. A set of parameters contains a travel dataset, e. g. PARAM CHANGE \ PCM \ PCM SET 1 \.

Description	Display
PCM Position 1	POS 1
PCM Acceleration 1	ACC 1
PCM Velocity 1	VEL 1
PCM Deceleration 1	DEC 1

## 2.4.3 Readable parameters menu

The readable parameters menu contains device information.

Description	Display	Chapter
Output Stage Temperature	OS DEG	<a href="#">5.9.1</a>
Virtual Motor Temperature	VM DEG	<a href="#">5.9.2</a>
Voltage of Control	C VOLT	<a href="#">5.9.3</a>
Voltage of Output Stage	P VOLT	<a href="#">5.9.4</a>
Motor Current	MotCur	<a href="#">5.9.5</a>
Actual Position	POS	<a href="#">5.9.6</a>
Actual Rotational Speed	VEL	<a href="#">5.9.7</a>
Overload	OVLOAD	<a href="#">5.9.8</a>
Gear Reduction	REduc	<a href="#">5.9.10</a>
Encoder Resolution	EncRES	<a href="#">5.9.11</a>
Digital Inputs State	DI4321	<a href="#">5.7.7</a>
Digital Output State	DO 1	
SW Motor Controller	VErDrv	<a href="#">5.9.13</a>
SW Ethernet Module	VErMod	<a href="#">5.9.14</a>

Description	Display	Chapter
Serial Number	SER No	<a href="#">5.9.12</a>
Production Date	DtProd	<a href="#">5.9.15</a>
IP Address	IP 1.2 / 3.4	<a href="#">4.1.1</a>
Subnet Mask	SNM 1.2 / 3.4	<a href="#">4.1.1</a>
Gateway Address	GW 1.2 / 3.4	<a href="#">4.1.1</a>

#### 2.4.4 Error memory menu

The error memory menu contains the number and type of errors that occurred (see chapter [3.3.2.1](#)). Up to ten errors are stored non-volitely in the error memory. Empty memory locations are not listed in the menu. The last error is at the lowest position in the menu.

Description	Display
Number of errors	Err No
Error number 1	Err 01
:	:
Error number 10	Err 10

Example: Err No = 6 > The last error is in the menu entry Err 06.

### 3 Functional description

If there is no upstream control, you can control the drive via keys or digital inputs and service interface, respectively. You can configure the drive via display and service interface.

#### 3.1 User units

With factory settings, the drive works with 1024 steps per revolution. If scaling is desired, with no need to consider the internal gearbox, the Spindle Pitch (see chapter [5.1.2](#)), Gear Ratio Numerator (see chapter [5.1.3](#)) and Gear Ratio Denominator (see chapter [5.1.4](#)) parameters must be set correspondingly.

The scaled position value is calculated as follows:

$$\text{Position Actual Value [User units]} = \frac{\text{internal position value [steps]} \times \text{Spindle Pitch}}{\text{Encoder Resolution [steps]} \times \text{ext. gear ratio}}$$

The external gear ratio is calculated as follows (see chapter [3.1.3](#)):

$$\text{external gear ratio} = \frac{\text{Gear Ratio Numerator}}{\text{Gear Ratio Denominator}}$$

Value jumps will occur if scaling exceeds the absolute encoder's basic resolution of 1024 steps per revolution.

The following condition shall be met for this reason:

$$\frac{\text{Spindle Pitch}}{\text{external gear ratio}} \leq 1024$$

The travel range expressed as user units is calculated with the following formula:

$$\text{Travel range max. [user units]} = \frac{2097151 \text{ steps} \times \text{Spindle Pitch}}{1024 \text{ steps} \times \text{external gear ration}}$$

$$\text{Travel range min. [user units]} = \frac{-2097152 \text{ steps} \times \text{Spindle Pitch}}{1024 \text{ steps} \times \text{external gear ration}}$$

### 3.1.1 Example of spindle drive

Spindle pitch  $p = 2 \text{ mm}$

The drive is mounted directly to a spindle.

The desired unit of the position value is  $1/100 \text{ mm}$ .

The Spindle Pitch parameter (see chapter 5.1.2) is calculated with the following formula:

$$\text{Spindle Pitch} = \frac{p}{\text{User unit}} = \frac{2 \text{ mm}}{0.01 \text{ mm}} = 200$$

### 3.1.2 Example of toothed rod/pinion, straight toothing, metric division

Division  $p = 5 \text{ mm}$

Number of pinion teeth  $z = 20$

The desired unit of the position value is  $1/10 \text{ mm}$ .

The Spindle Pitch parameter (see chapter 5.1.2) is calculated with the following formula:

$$\text{Spindle Pitch} = \frac{p \times z}{\text{User unit}} = \frac{5 \text{ mm} \times 20}{0.1 \text{ mm}} = 1000$$

### 3.1.3 Example external gear

If an external gear is used, a factor can be programmed via the parameters Gear Ratio Numerator (see chapter 5.1.3) and Gear Ratio Denominator (see chapter 5.1.4) in order to include the gear ratio in position sensing.

The actuator is operated on a gear (Fig. 3) with transmission reduction of 5:1. For this purpose, the parameters must be programmed as follows:

- Parameter Gear Ratio Numerator = 5
- Parameter Gear Ratio Denominator = 1

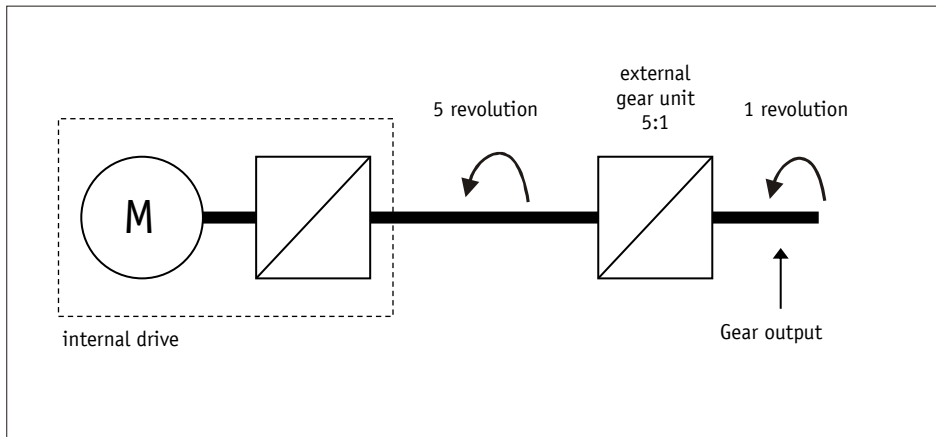

Fig. 3: External gear

Input of an odd gear transmission reduction value is possible according to the following example:

- Transmission reduction = 3.78
- Parameter Gear Ratio Numerator = 378
- Parameter Gear Ratio Denominator = 100

## 3.2 Protective functions

### 3.2.1 Current limiting

<b>NOTICE</b>	The actual motor current cannot be indicated by measuring the supply current. With cycled output stages, the supply current does not correspond to the motor current. Actual motor current can be read via the interface.
---------------	---

The current limit is set via parameter Peak Current Limit (see chapter 5.3.3), which serves primarily for protecting the drive against overload.

With default set, nominal speed indicated on the data sheet is achieved.

Actuator overload results in limiting the motor current to the set value.

As a consequence, the actuator cannot maintain the speed set, the contouring error increases. The actuator changes to the error status if the contouring error exceeds the contouring error limit defined by the Contouring Error Limit parameter (see chapter 5.3.6): contouring error.



### 3.2.2 I2t monitoring

I2t monitoring serves the protection of the output stage and gear.

The I2t limit is calculated with the following formula:

$$I2TLIMIT [A^2s] = ((Peak\ Current\ Limit[A])^2 - (Continuous\ Current\ Limit[A])^2) * Peak\ Current\ Time[s]$$

The resulting peak current time is calculated with the following formula:

$$T[s] = \frac{I2TLIMIT[A^2s]}{(Motor\ Current[A])^2 - (Continuous\ Current\ Limit[A])^2}$$

### 3.2.3 Temperature monitoring

The temperature of the output stage is measured directly on the output stage board. The output stage is switched off at 90 °C.

The motor temperature is calculated from the motor current based on a thermal model. An error is triggered when the motor temperature exceeds 105 °C.

### 3.2.4 Overvoltage protection with energetic recovery

<b>NOTICE</b>	Active overvoltage protection of the operating voltage of the output stage is effective only with operating voltage of the control switched on.
---------------	---

<b>NOTICE</b>	The response of active overvoltage protection causes immediate sluggishness of the driving shaft. This shall be considered when the driving shaft is adjusted manually.
---------------	---

Besides overvoltage protection by means of passive overvoltage protection elements, the actuator offers also active overvoltage protection of the operating voltage +UB output stage. In case of voltage rise caused by energetic recovery (e. g., foreign adjustment), the motor coils will be short-circuited for at least 4 s if the voltage of 32 V is exceeded. Excess energy will be converted to heat in the motor coils.

### 3.2.5 Contouring error monitoring

Disturbance variables such as load and friction may lead to the actuator's inability to follow the calculated travel profile. If the control deviation of the PID-positioning controller exceeds the value defined by the Contouring Error Limit parameter (see chapter 5.3.6), the contouring error will be triggered.

### 3.3 Warnings / Errors

#### 3.3.1 Warnings

Warnings do not influence the operation of the actuator.  
Warnings disappear after removing the cause.

Possible warnings:

- Current limiting active. The current limiting bit (bit 12) is set in the status word (see chapter 3.4.1.7).

#### 3.3.2 Errors

Errors cause an immediate stop of drive movement. For drives with the brake option, the brake is activated. The drive will be activated if there is no brake option.

An error is indicated via the drive status LEDs and the display.

The error bit (Bit 7) is set in the status word

The error messages are entered in the error memory in the order of their detection. The last 10 error messages are displayed when the error memory is full.

The cause of error can be tracked down with the help of the error codes.

##### 3.3.2.1 Error codes

<b>NOTICE</b>	If the error cannot be acknowledged after removal of the cause of error and the error persists after power-on reset, then the drive must be inspected in the factory.
---------------	---

Error code	Display	Fault	Trouble shooting
00h	-	No error	
07h	C UVLT	Low control electronics voltage	check control operating voltage
08h	C OVLT	Control electronics overvoltage	check control operating voltage
09h	P OVLT	Power electronics overvoltage	check output stage operating voltage
0Ah	TMP OS	Output stage excess temperature	reduce ambient temperature reduce load
0Bh	LAG	Contouring error	reduce load reduce acceleration or speed
0Ch	BLOCK	Output shaft blocked	disengage shaft
10h	Q10VR	EEPROM queue overrun	internal error
13h	CSEEP	EEPROM check sum	reset parameters to factory settings
14h	M WDER	Ethernet module watchdog	internal error

Error code	Display	Fault	Trouble shooting
15h	M ERRO	Ethernet module in the ERROR status while travel job is active	internal error
16h	M EXCE	Ethernet module in EXCEPTION state	internal error The behavior of the drive when this fault occurs can be set with the parameter configuration, bit 6 (see chapter 5.5.7).
17h	ACYTO	Timeout in acyclic data exchange	check cycle time of the control
20h	I2T	I2T limit exceeded	reduce load reduce acceleration or velocity
21h	TMO MO	Motor overtemperature	reduce load or duty cycle
22h	ENCODR	Encoder error	internal error

Table 1: Error codes

### 3.4 Operating modes

The following operating modes are distinguished: positioning mode and speed mode. In the positioning mode, inching operation is additionally available. Drive control via digital inputs and Position Control Mode is possible independent of the chosen operating mode.

#### 3.4.1 Positioning mode

In the positioning mode, positioning to the specified set point is executed by means of a ramp function (Fig. 4) calculated on the basis of the actual position as well as the programmed controller parameters acceleration and speed.

After activating the travel job, the actuator accelerates with the acceleration A-Pos (see chapter 5.2.2) to velocity V-Pos (see chapter 5.2.3). The measure of delay until reaching the set point is also A-Pos.

Alternately, the delay D-Pos (see chapter 5.2.4) can also be used to configure a value that deviates from the acceleration.

The actuator is repositioned to the calculated path by means of PID position controller. The controller can be optimized and adjusted to the local conditions via the Controller Parameter P (see chapter 5.6.1), Controller Parameter I (see chapter 5.6.2) and Controller Parameter D (see chapter 5.6.3) controller parameters.

Changing controller parameters during a positioning process does not influence the current positioning operation.

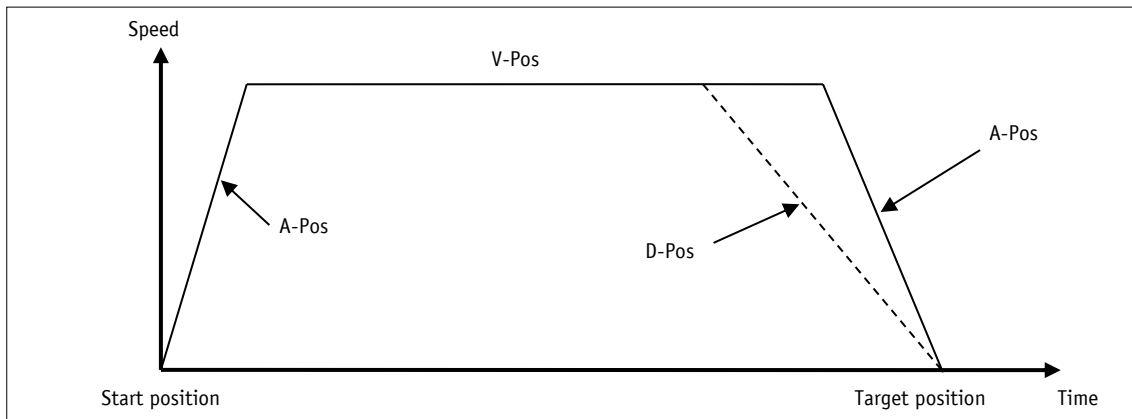

Fig. 4: Ramp travel, direct positioning mode

If the actual position is inside the window defined by the Pos Window parameter (see chapter 5.1.5), this will be signaled by Bit 5 = 1 in the status word. Upon reaching the programmed window via parameter (see chapter 5.1.8), you can define the behavior of the actuator.

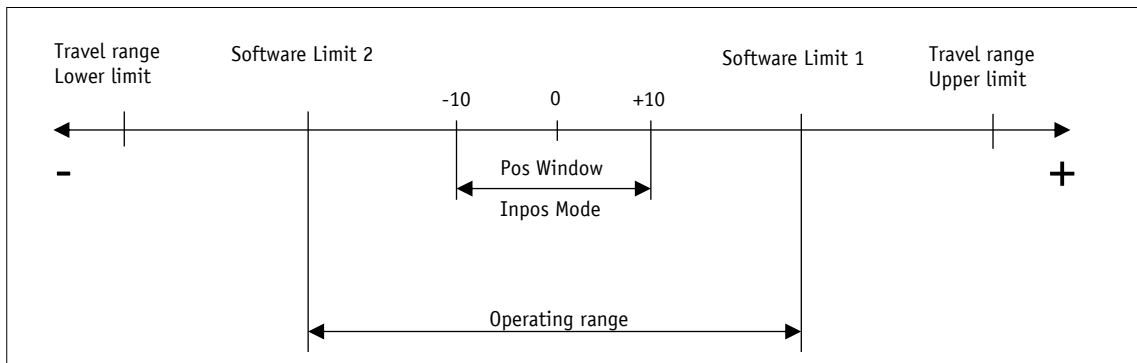

Fig. 5: Positioning mode

### 3.4.1.1 Limiting values

<b>NOTICE</b>	<p>Positioning operating mode:                  If Software Limit 1 (see chapter 5.3.1) is equal Software Limit 2 (see chapter 5.3.2), then monitoring of the software limiting value is deactivated. If the resolution of the absolute encoder is exceeded, there will be a jump of the actual position.</p> <p>Speed operating mode: insignificant</p>
---------------	--

<b>NOTICE</b>	<p>If the drive's position is outside the operating range defined by Software Limit 1 and Software Limit 2, then traveling is only enabled in inching mode in the direction of the operating range.</p>
---------------	---

The Software Limit 1 (see chapter 5.3.1) and Software Limit 2 parameters (see chapter 5.3.2) define the operating range of the drive. Travel jobs with target positions outside the operating range or which are equal the limiting value will not be executed. If the operating range is left in inching operation, the drive will be stopped. If the brake option is available for the drive, it will be activated whereas the drive will be activated if there is no brake option.

### 3.4.1.2 Limit switch

If the limit switch function is to be used, two digital inputs must be configured correspondingly.

#### 3.4.1.2.1 Example of a configuration

Example of a configuration for the connection of proximity switches DC PNP N/C contacts (NC).

Parameter	Value	Chapter
Digital Input 1 Functionality	1	<a href="#">5.7.1</a>
Digital Input 2 Functionality	2	<a href="#">5.7.2</a>
Digital Inputs Polarity	3	<a href="#">5.7.5</a>
Digital Input Functionalities State	-	<a href="#">5.7.6</a>

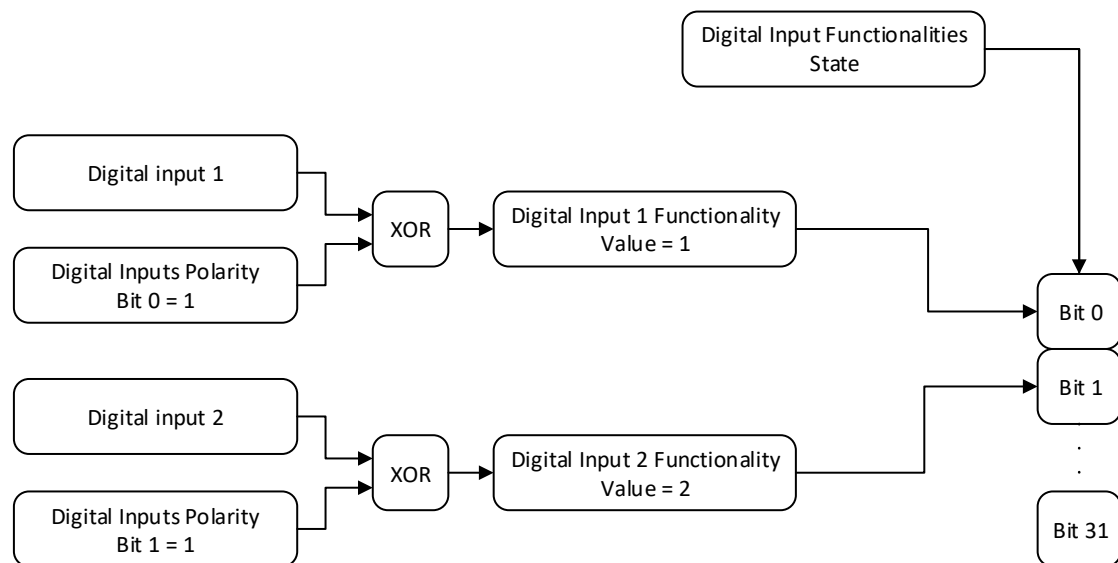

Fig. 6: Example of a limit switch configuration

### 3.4.1.2.2 Assembly of the limit switches

The limit switches are assembled according to the following pattern independent of the configured sense of rotation:

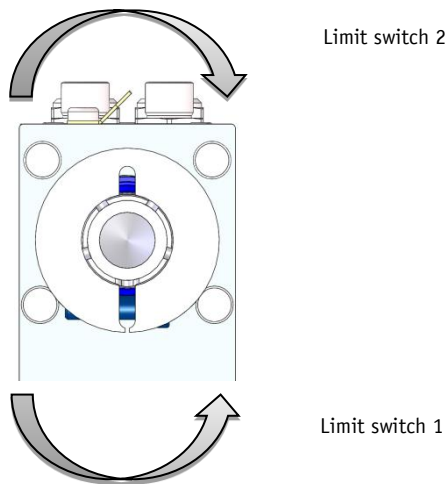

Fig. 7: Assembly of the limit switches

### 3.4.1.3 Loop positioning

<b>NOTICE</b>	A travel order will not be executed if loop positioning would exceed the limiting values specified by parameters Software Limit 1 (see chapter 5.3.1) and Software Limit 2 (see chapter 5.3.2) although the set point is within the limiting values.
---------------	--

If the actuator is operated on a spindle or an additional transmission, the spindle or external gear backlash can be compensated by means of loop positioning. In this case, traveling to the target value is always from the same direction. This travel direction can be determined via parameter Pos Type (see chapter 5.1.9). Loop length is set via parameter Loop Length (see chapter 5.1.10).

Example:

The direction from which every target position shall be driven to is positive.

- Case 1  $\Rightarrow$  new position is greater than actual position:  
Direct travel to required position
- Case 2  $\Rightarrow$  new position is smaller than actual position:  
The actuator drives beyond the target position by the loop length; afterwards, the set point is approached in positive direction.

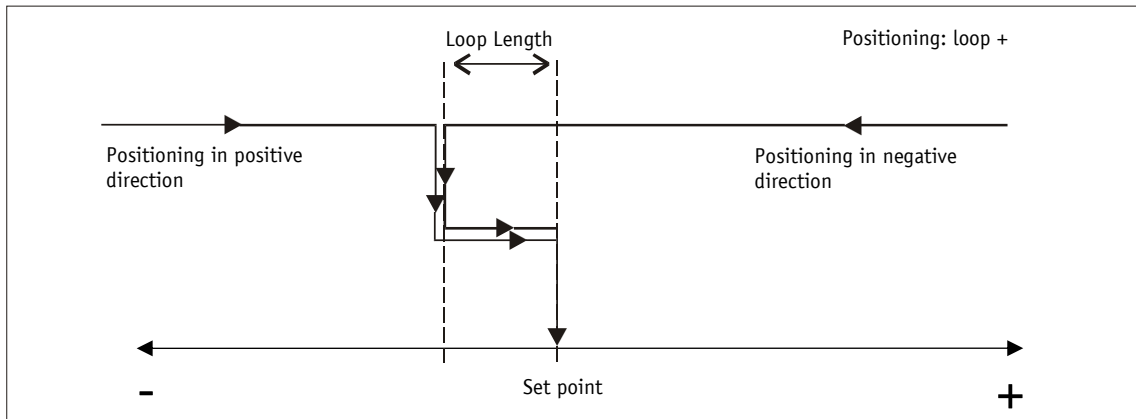

Fig. 8: Positioning Loop+

### 3.4.1.4 Inching operation

<b>NOTICE</b>	There is no compensation for spindle backlash (loop positioning) in this operating mode.
---------------	--

Inching operation is enabled in the positioning mode only. You can program via parameters acceleration as well as speed in the inching operation.

#### 3.4.1.4.1 Inching operation 1

<b>NOTICE</b>	If the actual position is outside the programmed limiting values, then traveling from this position in the respective direction must be performed by means of inching operation 1 or 2.
---------------	---

The drive travels once from the current actual position by the value Delta Inch (see chapter 5.1.7) depending on the mathematical sign of the value entered:

- Delta Inch < 0: negative travel direction
- Delta Inch > 0: positive travel direction

Reaching of the target position will be signaled accordingly.

The digital input can be configured for starting inching operation 1.

The following conditions must be met for enabling the start of inching operations 1 and 2:

- Supply voltage of the output stage is applied
- Operation enabled
- Drive stands still

### 3.4.1.4.2 Inching operation 2

The actuator travels from the current position as long as the relevant command is active. You can influence the inching speed via two parameters and it will be calculated in the actuator as illustrated in the example below:

- V-Inch (see chapter 5.2.6) = 10 rpm (can only be changed in the idle state)
- Inching 2 Offset (see chapter 5.2.7) = 85 % (can be changed during inching operation)

The resulting inching speed in this example will be:

- Inching speed = v - Tipp \* Offset inching 2 = 10 rpm \* 85 % = 9 rpm

Results are always rounded to integers.

Minimum speed is 1 rpm.

### 3.4.1.5 Travel Against Load

<b>NOTICE</b>	This function is only available in connection with the spring force brake option.
---------------	---

<b>NOTICE</b>	The Travel Against Load function, if activated, is only available in inching operation 1, inching operation 2 and in the positioning mode.
---------------	--

Traveling against a pressing load causes temporary displacement of the axis contrary to the direction of movement when the brake is opened because the motor had not been able to build up torque. This effect can be counteracted via the Travel Against Load function. The spring force brake will not be opened until the motor current exceeds the value of the Travel Against Load Trigger parameter (see chapter 5.3.7). Thus, the motor is able to build up torque before the brake is opened.

The Travel Against Load Direction parameter (see chapter 5.3.8) defines the travel direction where the function is intended to be active.



## 3.4.1.6 Control word: Positioning mode (master ⇒ slave)

Bit	Description
Bit 0 OFF1 (activate)	0 = OFF1 active Current travel job is canceled. The actuator is activated. 1 = OFF1 inactive
Bit 1 OFF2 (max. delay)	0 = OFF2 active Current travel job is canceled. The actuator is decelerated with max. delay, the actuator continues to be controlled. 1 = OFF2 inactive
Bit 2 OFF3 (progr. delay)	0 = OFF3 active Current travel job is canceled. The actuator is decelerated with programmed delay, the actuator continues to be controlled. 1 = OFF3 inactive
Bit 3 Intermediate stop	0 = no intermediate stop 1 = intermediate stop active
Bit 4 Start travel job	Positive flank starts a travel job
Bit 5 Acknowledge error	Positive flank acknowledges an error Afterwards, the actuator changes to the switch-lock state.
Bit 6 Inching operation 1	0 = no inching operation 1 If the inching operation is not completed yet it will be canceled. 1 = inching operation 1 As long as this bit is set, the actuator travels the distance specified in parameter Delta Tipp.
Bit 7 Inching operation 2 positive	0 = no inching operation 2 positive 1 = inching operation 2 positive The actuator travels in positive direction
Bit 8 Inching operation 2 negative	0 = no inching operation 2 negative 1 = inching operation 2 negative inching operation 2 negative
Bit 9 Key enable	0 = Key enable as defined by the Key Function Enable parameter (see chapter 5.5.2) 1 = Key enable inverted as defined by the Key Function Enable parameter
Bit 10 Relative positioning	0 = absolute positioning 1 = relative positioning
Bit 11 ... 14	Reserved, always 0
Bit 15 Calibration	Positive edge calibrates the drive (see chapter 3.4.5)

Table 2: Positioning mode control word

## 3.4.1.7 Status word: Positioning mode (slave ⇒ master)

Bit	Description
Bit 0 Operating voltage	0 = output stage operating voltage missing 1 = operating voltage of the output stage is applied
Bit 1 Readiness to travel	0 = not ready to travel 1 = ready to travel
Bit 2 Upper limit	0 = no violation of limit 1 = upper limit exceeded
Bit 3 Lower limit	0 = no violation of limit 1 = lower limit undercut
Bit 4 Actuator travels/stands still	0 = actuator stands still 1 = actuator travels
Bit 5 Inpos	0 = actuator is outside the position window 1 = actuator is inside the position window
Bit 6 Active travel job	0 = no active travel job 1 = active travel job
Bit 7 Error	0 = no error 1 = Error Acknowledgment with positive flank on Control word bit 5
Bit 8 Operation enabled	0 = operation not enabled 1 = operation enabled
Bit 9 Switch-lock	0 = no switch-lock 1 = switch-lock
Bit 10 Travel job acknowledgment	0 = no acknowledgment 1 = acknowledgment The bit is set when the travel job was adopted. If bit 4 is reset in the control word, this bit will be reset as well.
Bit 11	no function
Bit 12 Current limiting	0 = current limiting inactive 1 = current limiting active Motor current exceeds the value set under parameter Peak Current Limit (see chapter 5.3.3).
Bit 13 Limit switch 1	0 = Limit switch inactive 1 = Limit switch active (Configuration of a digital input required) (see chapter 5.7.1).
Bit 14 Limit switch 2	0 = Limit switch inactive 1 = Limit switch active (Configuration of a digital input required).
Bit 15 Calibration acknowledgment	0 = no acknowledgment 1 = Acknowledgment The bit is set when calibration has been completed successfully. If Bit 15 is reset in the control word, this bit is reset as well.

Table 3: Status word of positioning mode

3.4.1.8 Flow chart: Operating mode Positioning mode

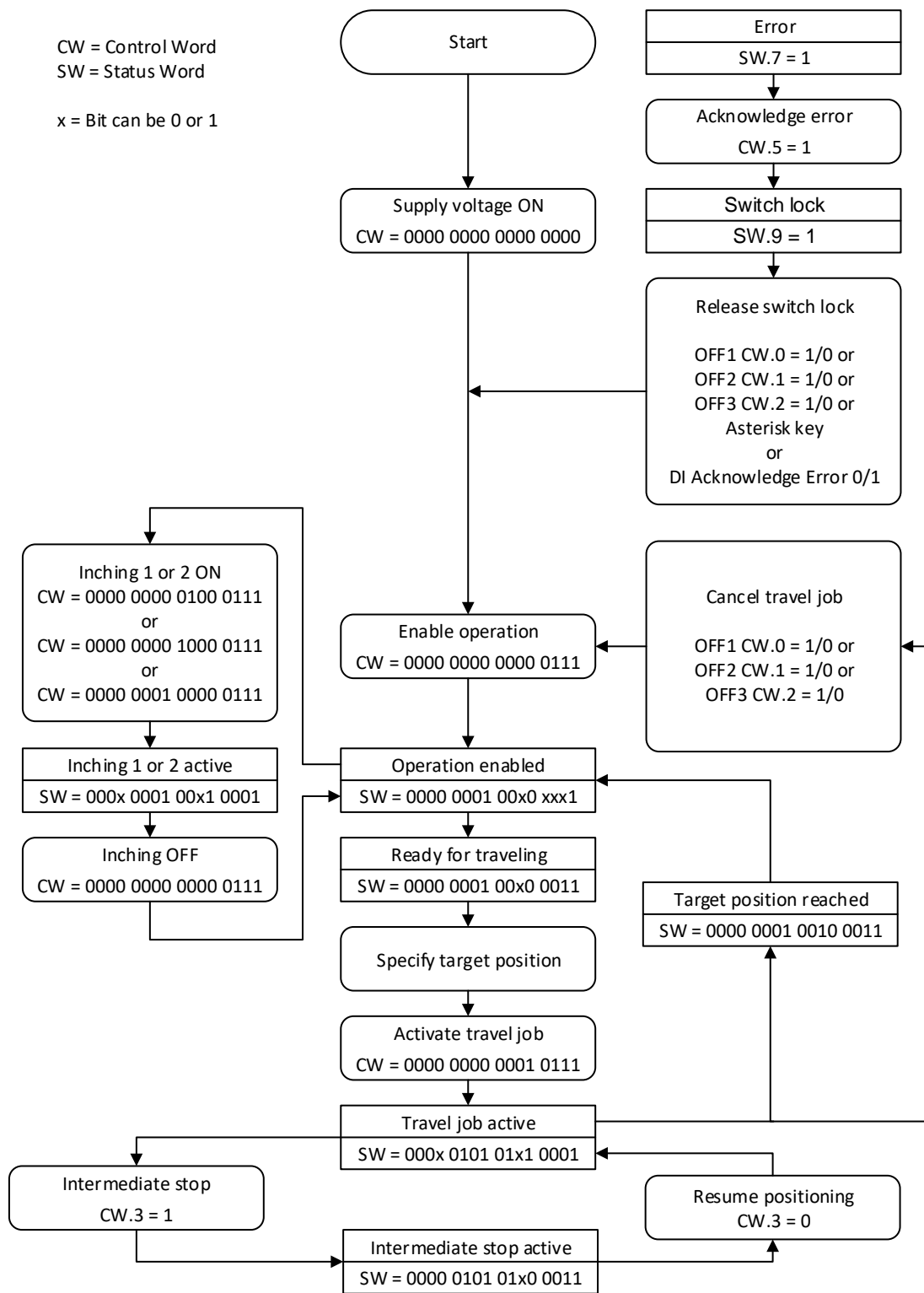



Fig. 9: Flowchart positioning mode

### 3.4.2 Local control (Stand-Alone Operation)

#### 3.4.2.1 Inching operation 2

After applying the operating voltage to the control, the actuator will be on the uppermost level of the menu structure, positioning mode is active (factory setting).

Pressing the  - key starts leftward travel (inching operation 2).

Pressing the  - key starts rightward travel (inching operation 2).

Releasing the respective key stops travel movement.

Pressing the  - key starts the parameter / programming mode.

#### 3.4.2.2 Specifying the set point





<b>NOTICE</b>	Travel jobs started in stand-alone operation can be canceled anytime by pressing the  key.
---------------	---

<b>NOTICE</b>	The set point setting submenu can also be quit without starting a travel job. For this purpose, you must wait a period of 30 seconds without actuating a key. Afterwards, there will be an automatic return to the normal display.
---------------	--







Example: Starting positioning order to position 500

##### Preconditions:

- The display is at the uppermost level of the menu structure (basic state).
- Operating mode: Positioning mode
- Key functions: enabled

0 0	Initial state: normal display First press the  key, then the  key and hold down together.
TARGET 3	The Key Enable Time (see chapter 5.5.1) is counted down.
TARGET 000000	After expiry of the Key Enable Time, the input field is released. The first decimal place is active (flashing). Press the  key 2x to change to the third decimal place.
TARGET 000000	The third decimal place is active. Press the  key 5 times.
TARGET 000500	Value 500 will be displayed. Confirm by pressing the  key to start positioning.

Example: Starting positioning order to position -500

0 0	Initial state: normal display First press the  key, then the  key and hold down together.
TARGET 3	The Key Enable Time (see chapter 5.5.1) is counted down.
TARGET 000000	After expiry of the Key Enable Time, the input field is released. The first decimal place is active (flashing). Press the  key 2x to change to the third decimal place.
TARGET 000000	The third decimal place is active. Press the  key 5 times.
TARGET 000500	Value 500 will be displayed. Press the  key 3x to change to the sixth decimal place.
TARGET 000500	The sixth decimal place is active and flashes. Press the  key 11 times for setting the arithmetical sign.
TARGET -00500	Value -500 will be displayed. Confirm by pressing the  key to start positioning.

### 3.4.3 Digital inputs and outputs

The actuator has four configurable digital inputs and one configurable digital output.

Function and switching behavior can be set. The statuses of the digital inputs and outputs cannot be overwritten via software.

No function has been assigned to the digital inputs in the factory setting.

The logical status of the digital inputs is mapped in the process data independent of the assigned function.

If a function was assigned to the digital input, the functions conditions of the digital inputs can be read in the register Digital Input Functionalities State (see chapter 5.7.6).

With factory settings, the digital output can be actuated via the process data.

If a function is assigned to the digital output, it is actuated via register Digital Outputs Functionalities State (see chapter 5.7.10).

### 3.4.3.1 Examples of digital input configurations

The following configuration deviates from the factory setting and requires parameterization by the user.

- Digital input 1: Limit switch 1 (low-active) proximity switch DC PNP NC
- Digital input 2: Limit switch 2 (low-active) proximity switch DC PNP NC
- Digital input 3: Inching operation 2 positive travel direction (high-active) pushbutton
- Digital input 4: Inching operation 2 negative travel direction (high-active) pushbutton

Parameter	Value	Chapter
Digital Input 1 Functionality	1	<a href="#">5.7.1</a>
Digital Input 2 Functionality	2	<a href="#">5.7.2</a>
Digital Input 3 Functionality	3	<a href="#">5.7.3</a>
Digital Input 4 Functionality	4	<a href="#">5.7.4</a>
Digital Inputs Polarity	3	<a href="#">5.7.5</a>
Digital Input Functionalities State	-	<a href="#">5.7.6</a>

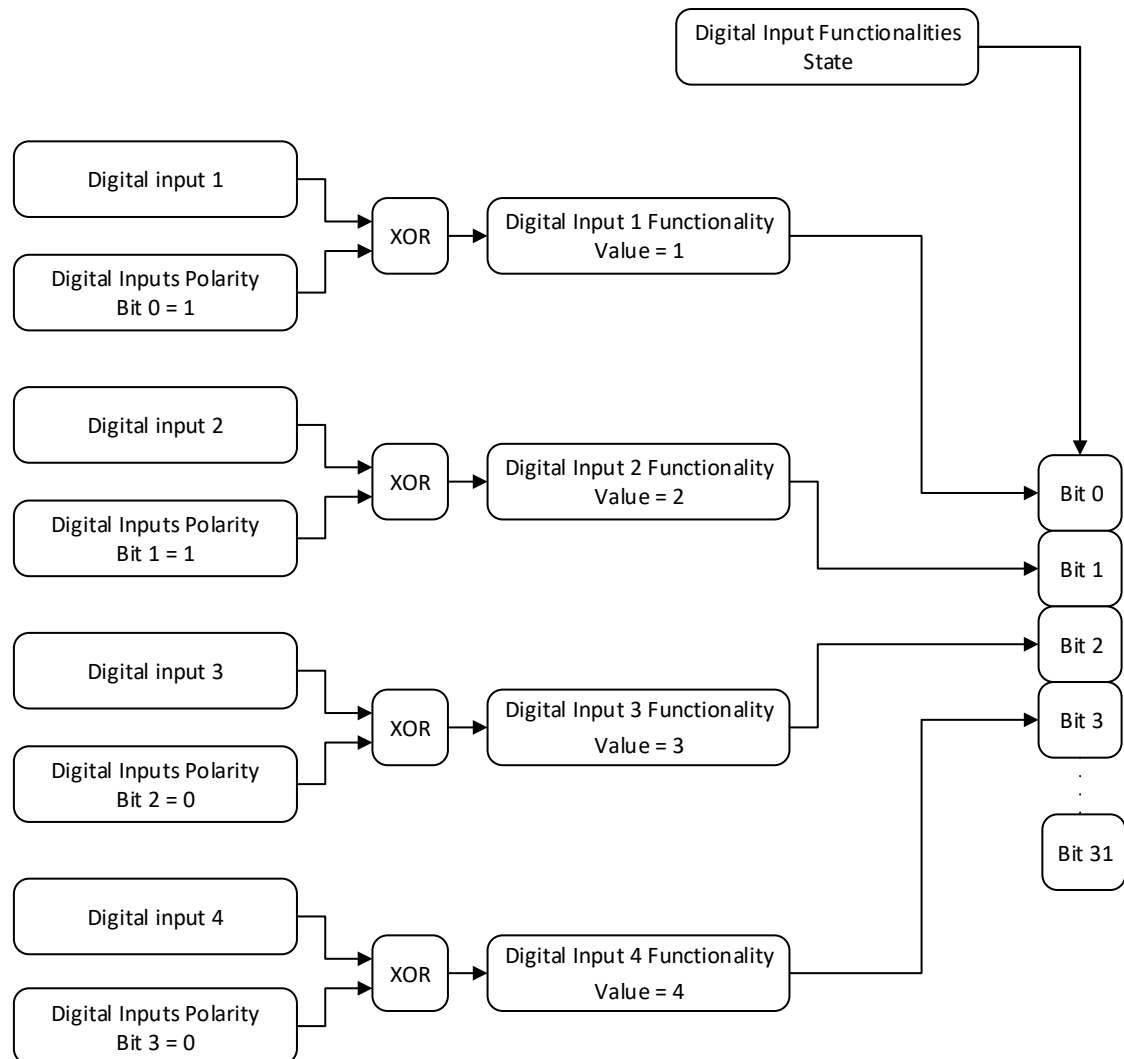

Fig. 10: Examples of digital input configurations

### 3.4.3.2 Example of digital output configuration

- Digital output 1: Inpos (high-active)

Parameter	Value	Chapter
Digital Output 1 Functionality	2	<a href="#">5.7.8</a>
Digital Outputs Polarity	0	<a href="#">5.7.9</a>
Digital Output Functionalities State	-	<a href="#">5.7.10</a>

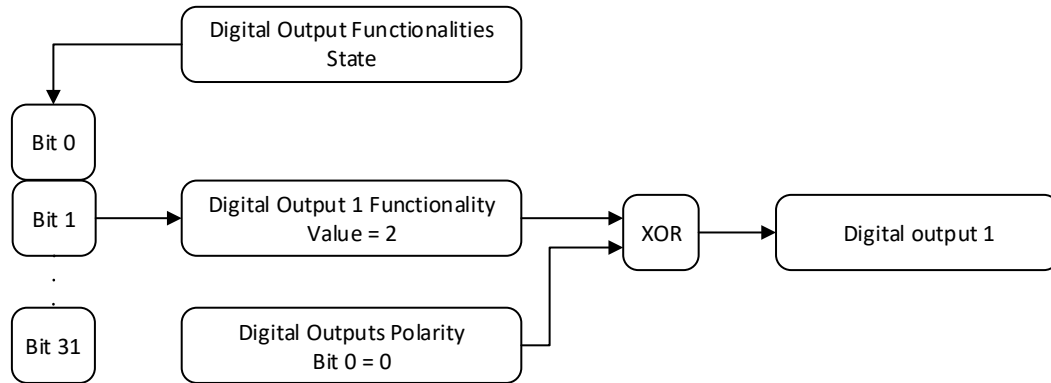

Fig. 11: Example of digital output configuration

### 3.4.4 Position Control Mode

<b>NOTICE</b>	<p>Via the control word in the process data, the superordinate control can cancel travel jobs started by the position control mode. For this purpose, a negative flank must be created on bits OFF1, OFF2, or OFF3 in the control word. Conversely, the PCM mode cannot cancel a travel order initiated via the superordinate control.</p>
---------------	--

The position control mode enables travel data sets to be called via the digital inputs. A total of 7 travel data sets can be saved.

The use of the position control mode requires previous configuration of the digital inputs.

The desired travel data set can be selected via PCM inputs 1 to 3 in binary addressing. Travel data set 0 does not exist.

### 3.4.4.1 Examples of configuration of the digital inputs for the PCM

- Digital input 1: PCM start (high-active)
- Digital input 2: PCM input 1 (high-active)
- Digital input 3: PCM input 2 (high-active)
- Digital input 4: PCM input 3 (high-active)

Parameter	Value	Chapter
Digital Input 1 Functionality	8	<a href="#">5.7.1</a>
Digital Input 2 Functionality	9	<a href="#">5.7.2</a>
Digital Input 3 Functionality	10	<a href="#">5.7.3</a>
Digital Input 4 Functionality	11	<a href="#">5.7.4</a>
Digital Inputs Polarity	0	<a href="#">5.7.5</a>
Digital Input Functionalities State	-	<a href="#">5.7.6</a>

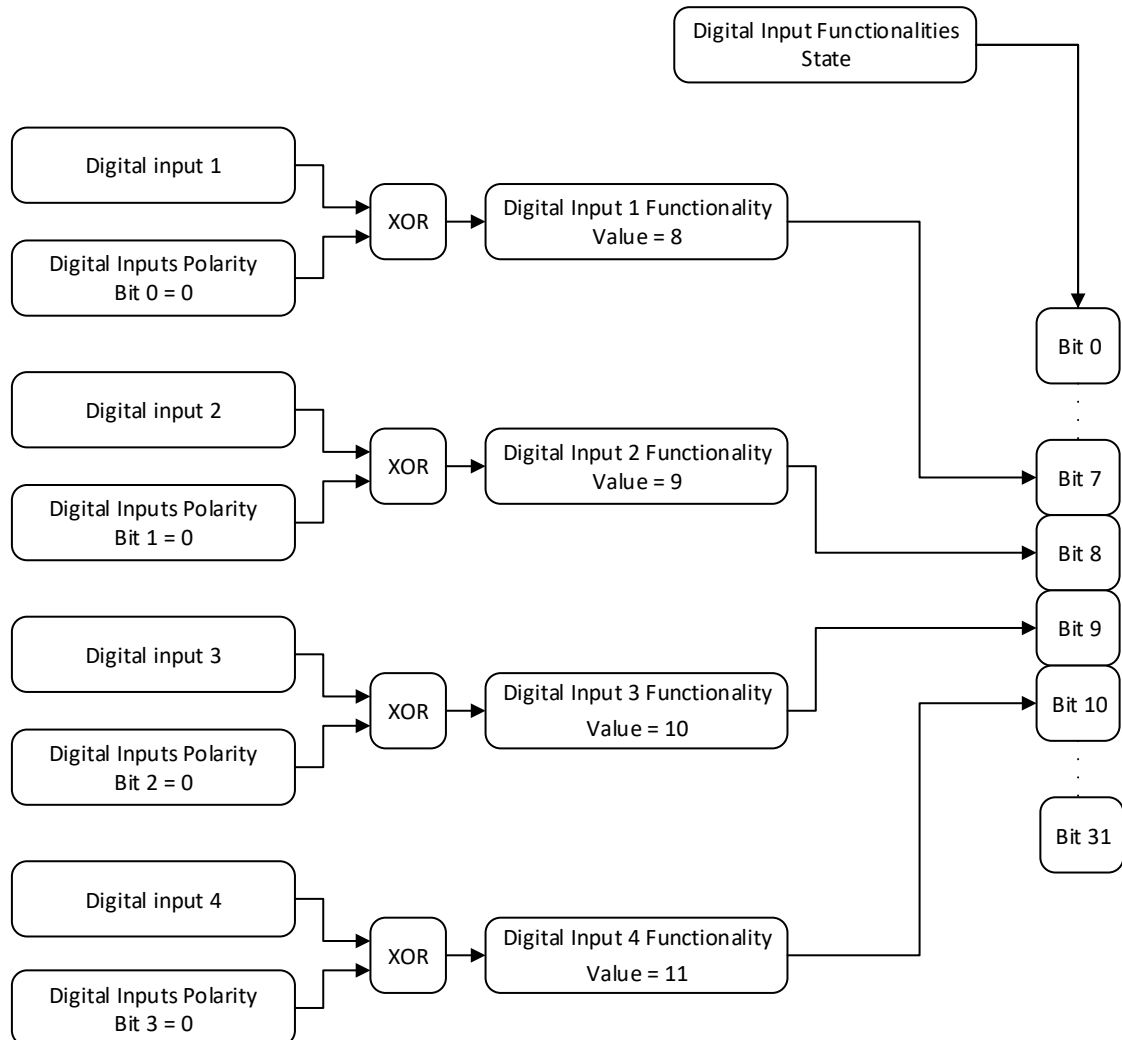

Fig. 12: Examples of configuration of the digital inputs for the PCM



Example of the parameter set of travel data set no. 3.

Parameter	Chapter
PCM Position 3	<a href="#">5.8.3</a>
PCM Acceleration 3	<a href="#">5.8.10</a>
PCM Velocity 3	<a href="#">5.8.17</a>
PCM Deceleration 3	<a href="#">5.8.24</a>

After applying the coding to the inputs, the desired travel job can be started by a positive flank on the PCM Start input.

Resetting the PCM Start input during an active positioning process will result in cancellation of the travel job but the drive will continue to be controlled.

An example of calling travel data set no. 3 is shown below.

Step 1: Create number of travel data set.

Input	State
PCM Start	0
PCM input 1	1
PCM input 2	1
PCM input 3	0

Step 2: Start the positioning job.

Input	State
PCM Start	0/1
PCM input 1	1
PCM input 2	1
PCM input 3	0

### 3.4.5 Calibration

<b>NOTICE</b>	Calibration is only possible when no travel job is active and the drive is idle (no foreign adjustment).
---------------	--

Two steps are required for executing calibration:

- Write calibration value: Parameter Calibration Value (see chapter [5.1.11](#))
- Execute calibration (software command or calibration input)

Calibration can be triggered by a positive flank to control word 15 or by writing the value 7 to the S-Command parameter (see chapter [5.5.8](#)). Alternately, a digital input can be configured as calibration input as well.

Since the measuring system is an absolute system, calibration is necessary only once with commissioning. With calibration, the calibration value is adopted for calculation of the position value. The following equation is applied in case of calibration:

- Position value = 0 + calibration value + offset value (see chapter [5.1.6](#))

Changes to the offset value are immediately included in the calculation of the position value.

### 3.4.6 Sense of Rotation

**NOTICE**

With a change of the sense of rotation, the arithmetic sign of the actual position will be changed.

With the Sense of Rotation parameter (see chapter 5.1.1), the travel direction can be adjusted to the mechanical conditions.

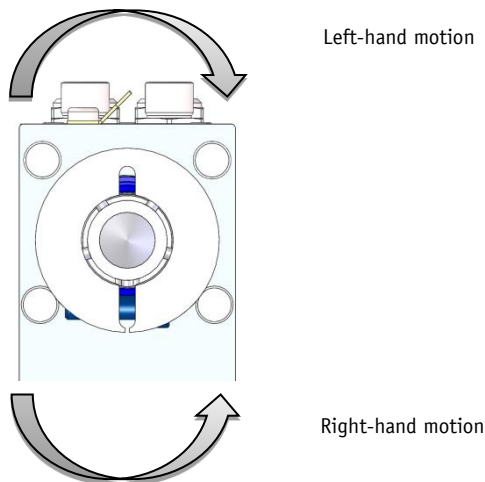

Fig. 13: Sense of rotation

### 3.4.7 Rotational speed mode

**NOTICE**

Limits 1 + 2 are inactivated in this operational mode.

**NOTICE**

For signaling the speed mode, both direction indicators are activated in the display.

**NOTICE**

Exceeding the resolution of the absolute encoder results in a jump of the actual position.

With the set point enabled, the actuator when in the rotational speed mode accelerates to the target speed and maintains this speed until the set point is disabled or a different target speed specified. Speed is adjusted immediately to the new value when the rotational target speed is changed.

The arithmetical sign of the set point determines the travel direction in the rotational speed mode.

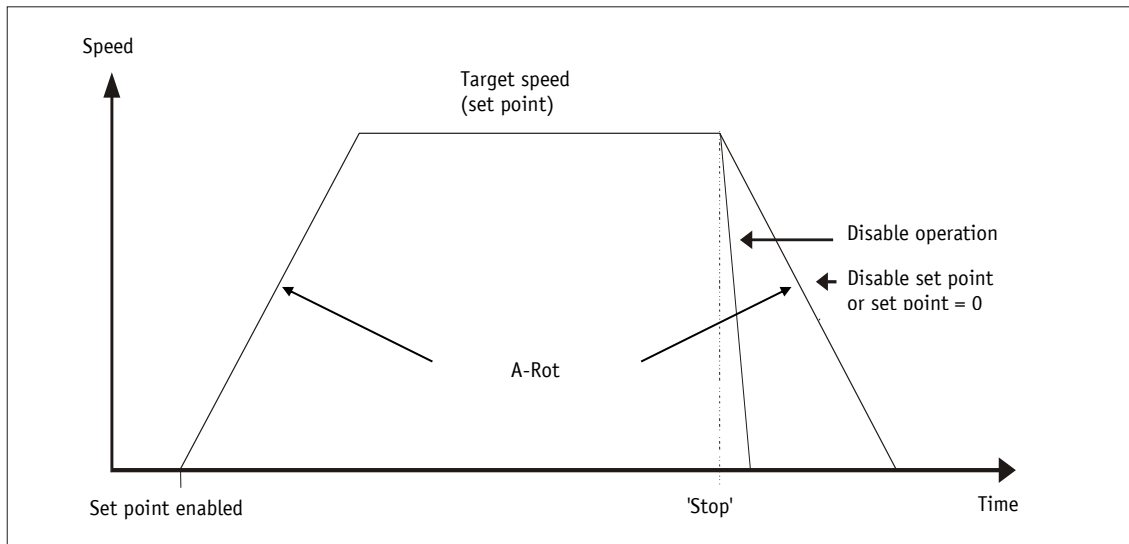

Fig. 14: Ramp speed mode

The following conditions must be met for enabling the start of the rotational speed mode:

- Supply voltage of the output stage is applied
- Operation enabled
- Drive stands still

If the actual speed is inside the window defined by the Pos Window parameter (see chapter 5.1.5), this will be signaled in the status word Bit 5 = 1.

### 3.4.7.1 Control word Operating mode: Speed mode

Bit	Description
Bit 0 OFF1 (activate)	0 = OFF1 active Current travel job is canceled. The actuator is activated. 1 = OFF1 inactive
Bit 1 OFF2 (max. delay)	0 = OFF2 active Current travel job is canceled. The actuator is decelerated with max. delay, the actuator continues to be controlled. 1 = OFF2 inactive
Bit 2 OFF3 (progr. delay)	0 = OFF3 active Current travel job is canceled. The actuator is decelerated with progr. delay, the actuator continues to be controlled. 1 = OFF3 inactive
Bit 3	Reserved, always 0
Bit 4 Start travel job	Positive flank starts a travel job
Bit 5 Acknowledge error	Positive flank acknowledges an error Afterwards, the actuator changes to the switch-lock state.
Bit 6 ... 8	Reserved, always 0

Bit	Description
Bit 9 Key enable	0 = Key enable as defined by Key Function Enable parameter (see chapter 5.5.2) 1 = Key enable inverted as defined by Key Function Enable parameter
Bit 10 ... 14	Reserved, always 0
Bit 15 Calibration	Positive flank calibrates the drive (see chapter 3.4.5)

Table 4: Control word speed mode

### 3.4.7.2 Status word Operating mode: Speed mode

Bit	Description
Bit 0 Operating voltage	0 = output stage operating voltage missing 1 = operating voltage of the output stage is applied
Bit 1 Readiness to travel	0 = not ready to travel 1 = ready to travel
Bit 2	no function
Bit 3	no function
Bit 4 Actuator travels/stands still	0 = actuator stands still 1 = actuator travels
Bit 5 Inpos	0 = actuator is outside the position window 1 = actuator is inside the position window
Bit 6 Active travel job	0 = no active travel job 1 = active travel job
Bit 7 Error	0 = no error 1 = Error Acknowledgment with positive flank on Control word bit 5
Bit 8 Operation enabled	0 = operation not enabled 1 = operation enabled
Bit 9 Switch-lock	0 = no switch-lock 1 = switch-lock
Bit 10 Travel job acknowledgment	0 = no acknowledgment 1 = acknowledgment The bit is set when the travel job was adopted. If bit 4 is reset in the control word, this bit will be reset as well.
Bit 11	no function
Bit 12 Current limiting	0 = current limiting inactive 1 = current limiting active Motor current exceeds the value set under parameter Peak Current Limit (see chapter 5.3.3).
Bit 13 ... 14	no function
Bit 15 Calibration acknowledgment	0 = no acknowledgment 1 = Acknowledgment The bit is set when calibration was completed successfully. If bit 15 is reset in the control word, this bit is reset as well.

Table 5: Status word of speed mode

### 3.4.7.3 Flow chart: Operating mode Speed mode

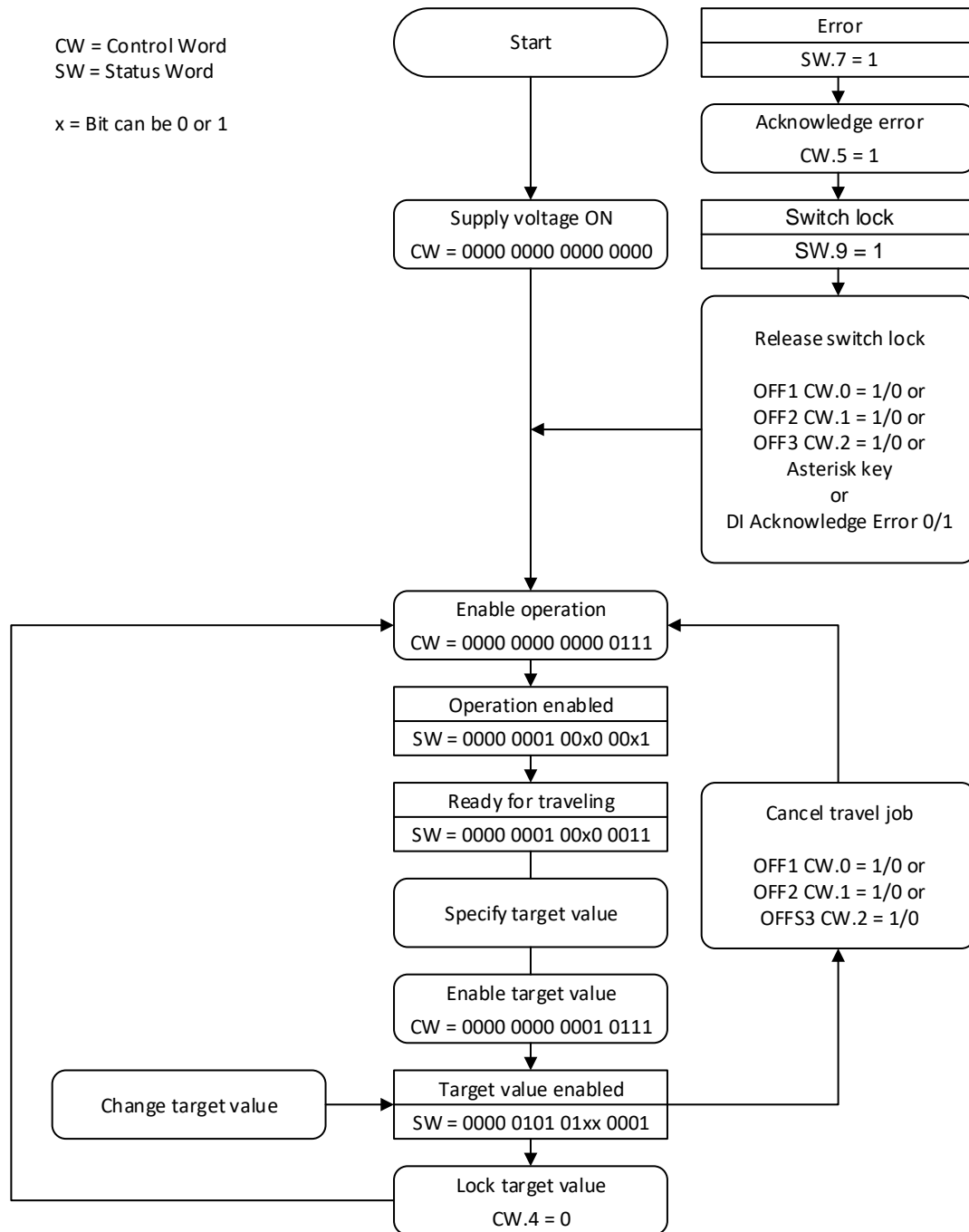

Fig. 15: Flow chart speed mode

## 4 EtherNet/IP™

### 4.1 Description

The drive has been designed as CIP Generic Device (Type 2Bh).

#### 4.1.1 IP-Configuration

<b>NOTICE</b>	After completing the settings, reset (soft boot) is required to ensure that the changed configuration is adopted.
---------------	---

<b>NOTICE</b>	The IP configuration can be reset to the factory setting by an S-Command (see chapter 5.5.8). The IP configuration is assigned to the parameter class N.
---------------	---

The IP configuration of the actuator can be performed via the network or the display menu. The selection in the PARAM CHANGE \ PARAM EIP \ NW SET menu determines the setting that will be used.

Display	Description
NETW	The setting is via the network (factory setting).
DEVICE	The setting is via the display menu.

With the factory setting, the IP configuration is done automatically via a DHCP server in the network. The following basic setting applies:

IP address	0.0.0.0
Subnet mask	0.0.0.0
Gateway	0.0.0.0
DHCP	Enabled

The IP configuration can be switched over to static via the IPconfig HMS software tool or the web server; i. e., DHCP is deactivated and the IP configuration set is stored non-volatilely.

If IP configuration is via the display menu (DEVICE selection), the following basic setting applies:

IP address	192.168.1.124
Subnet mask	255.255.255.0
Gateway	192.168.1.1
DHCP	Disabled

The active IP configuration can be indicated via the display.

IP address	PARAM RoPARA \ IP
Subnet mask	PARAM RoPARA \ SNM
Gateway	PARAM RoPARA \ GW

The IP configuration is in the PARAM CHANGE \ PARAM EIP display menu:

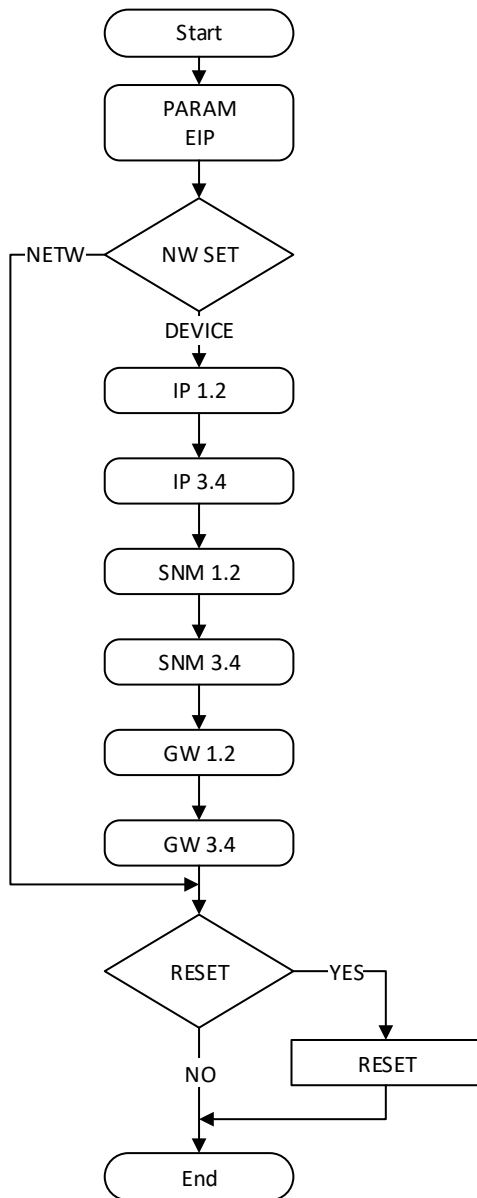

Fig. 16: Setting of the IP address

### 4.1.2 I/O Messages

Cyclic process data exchange is via I/O messages (class-1 connection). Two assemblies are available, which contain a collection of parameters required for the control of the drive.

Connection: Exclusive Owner

Target (drive) ⇒ Origin (master)

Assembly Object (04h), instance 64h

Instance	Description	Type
259	Actual Value	DINT
260	Generic Mapping Channel	DINT
258	Status Word	UINT
257	Digital Inputs State	UINT

Origin (master) ⇒ Target (drive)

Assembly Object (04h), instance 96h

Instance	Description	Type
3	Target Value	DINT
2	Control Word	UINT
1	Digital Outputs Control	UINT

### 4.1.3 Explicit Messages

Acylic exchange of parameter data is via explicit messages (class-3 connection).

The parameter values of the individual instances are accessed via class A2h, attribute 5.

### 4.1.4 ADI Object (Class A2h)

All drive parameters are contained in the Application Data Instance object. Every parameter corresponds to an instance in this class. Access to the parameters is via explicit messages.

Class attributes of the ADI object

Number	Access	Name	Description	Data type
1	Get	Revision	Object revision index	UINT
2	Get	Max. instances	Maximum number of object instances in this class	UINT
3	Get	Number of instances	Number of object instances in this class	UINT



Instance attributes of the ADI object

Number	Access	Name	Description	Data type
1	Get	Name	Parameter name (including length)	SHORT_STRING
2	Get	Data type	Data type of the instance value	USINT
3	Get	Number of elements	Number of elements of the specified Data type	USINT
4	Get		Bit field describing the access authorization for this instance Bit Meaning: 0 set= Get access 1 set= Set access	USINT
5	Get/Set	Value	Instance value	defined by attribute 2
6	Get	Max. value	The maximum admissible parameter value	
7	Get	Min. value	The minimum admissible parameter value	
8	Get	Default value	Standard value	

Access to the parameter values is via Get/Set Attribute Single, Attribute 5.

## 4.2 CIP objects

The following CIP objects are integrated in the actuator:

Class	Name	Description
01h	Identity Object	Contains device-specific data
02h	Message Router	
04h	Assembly Object	The Assembly Object enables access to process data
06h	Connection Manager	
0Fh	Parameter Object	Contains the available ports, port names and node addresses
47h	DLR Object	Contains status information of the DLR protocol
48h	QoS Object	Contains mechanisms for handling data streams with different priorities
53h	Power Management Object	
A2h	ADI Object	Enables access to the parameters of the actuator
F5h	TCP/IP Interface Object	Enables configuration of the TCP/IP interface
F6h	Ethernet Link Object	Contains connections-specific counters and status information

### 4.2.1 Identity Object (Class 01h)

The Identity Object contains device-specific data.

Services supported:

Class:

- Get\_Attribute\_Single
- Get\_Attributes\_All

Instance:

- Get\_Attribute\_Single
- Set\_Attribute\_Single
- Get\_Attributes\_All

Reset

#### 4.2.1.1 Class attributes of the Identity Object

Number	Access	Description	Data type	Default value
1	Get	Object revision index	UINT	0001h
2	Get	Maximum number of object instances in this class	UINT	
3	Get	Number of object instances in this class	UINT	

#### 4.2.1.2 Instance attributes of the Identity Object

Number	Access	Name	Data type	Default value
1	Get	Vendor-ID	UINT	053Eh
2	Get	Device Type	UINT	002Bh
3	Get	Product Code	UINT	0102h
4	Get	Revision Major Revision Minor Revision	Struct of: USINT USINT	01h 02h
5	Get	Status	WORD	
6	Get	Serial Number	UDINT	
7	Get	Product Name	SHORT_STRING	SIKO DriveLine AG24
11	Set	Active Language	Struct of: USINT USINT USINT	

Number	Access	Name	Data type	Default value
12	Get	Supported Language List	Array of: Struct of: USINT USINT USINT	

#### 4.2.1.3 Status

Bit(s)	Name	Description
0	Owned	0 = no connection to master 1 = connection to master established
1		Reserved
2	Configured	0 = device with standard configuration 1 = no standard configuration
3		Reserved
4 ... 7	Extended Device Status	Manufacturer-specific status bits Value Description 0000b Unknown 0010b At least one faulty I/O connection 0011b No I/O connection established 0100b Non-volatile configuration (EEPROM) faulty 0101b Serious error, bit 10 or bit 11 = 1 0110b At least one I/O connection in the "Run" mode 0111b At least one I/O connection established, all in the "Idle" operating mode Others reserved
8	Minor Recoverable Fault	0 = no error 1 = resettable error
9	Minor Unrecoverable Fault	0 = no error 1 = non-resettable error
10	Major Recoverable Fault	0 = no serious error 1 = resettable serious error
11	Major Unrecoverable Fault	0 = no serious error 1 = non-resettable serious error
12 ... 15		Reserved

#### 4.2.1.4 Reset service of the Identity Object

Type 0: Power Cycling Reset

The device carries out reset.

Type 1: Out of Box Reset

All parameters to factory settings; afterwards, the device carries out reset.

### 4.3 Commissioning aids

Service software, Add-On Instructions (AOI) or examples of projects including step-by-step instructions are available as commissioning aids.

## 5 Parameters

Parameters are classified. The classes C, E, N, S, and V can be separately reset to factory settings if necessary (see chapter [5.5.8](#)).

Parameter classes	Character
Controller parameters	C
Error memory	E
Network parameters	N
Standard parameters	S
Visualization parameters	V
Process data	PD

Chapter	starting with page
Positioning	<a href="#">45</a>
Actuator	<a href="#">56</a>
Limiting values	<a href="#">61</a>
Visualization	<a href="#">66</a>
Options	<a href="#">70</a>
Controller parameters	<a href="#">76</a>
Digital input/output	<a href="#">77</a>
Position Control Mode	<a href="#">87</a>
Device information	<a href="#">103</a>
Error memory	<a href="#">112</a>

## 5.1 Positioning

### 5.1.1 Sense of Rotation

General characteristics

EEPROM	yes
Class	S
Unit	-

EtherNet/IP

Data type	USINT
Access	Get/Set
Instance	1554d / 612h
Web server	1554

Service protocol

Read command	-
Write command	Tx

Display

Menu	PARAM CHANGE \ POSIT \ SEnRot
------	-------------------------------

Value range

Value	Display	Service protocol	Description
0 (default)	CW	T0	Sense of rotation i ascending position values with clockwise rotation
1	CCW	T1	Sense of rotation e ascending position values with counter-clockwise rotation

### 5.1.2 Spindle Pitch

General characteristics

EEPROM	yes
Class	S
Unit	-

EtherNet/IP

Data type	DINT
Access	Get/Set
Instance	1549d / 60Dh
Web server	1549

## Service protocol

Read command	G013
Write command	H013xxxxx

## Display

Menu	PARAM CHANGE \ POSIT \ SPItch
------	-------------------------------

## Value range

Value	Display	Description
0 ... 1000000		
0 (default)		No scaling. For calculating the position value in user units, the Spindle Pitch = 1024 value must be used.

### 5.1.3 Gear Ratio Numerator

## General characteristics

EEPROM	yes
Class	S
Unit	-

## EtherNet/IP

Data type	INT
Access	Get/Set
Instance	1547d / 60Bh
Web server	1547

## Service protocol

Read command	G010
Write command	H010xxxxx

## Display

Menu	PARAM CHANGE \ POSIT \ GEAR N
------	-------------------------------

## Value range

Value	Display	Description
1 ... 10000		
1 (default)		

### 5.1.4 Gear Ratio Denominator

General characteristics

EEPROM	yes
Class	S
Unit	-

EtherNet/IP

Data type	INT
Access	Get/Set
Instance	1548d / 60Ch
Web server	1548

Service protocol

Read command	G011
Write command	H011xxxxx

Display

Menu	PARAM CHANGE \ POSIT \ GEAR D
------	-------------------------------

Value range

Value	Display	Description
1 ... 10000		
1 (default)		

### 5.1.5 Pos Window

General characteristics

EEPROM	yes
Class	S
Unit	User units

EtherNet/IP

Data type	INT
Access	Get/Set
Instance	1546d / 60Ah
Web server	1546

Service protocol

Read command	G009
Write command	H009xxxxx

Display

Menu	PARAM CHANGE \ POSIT \ InPoSW
------	-------------------------------

Value range

Value	Display	Description
0 ... 1000		
10 (default)		

### 5.1.6 Offset Value

General characteristics

EEPROM	yes
Class	S
Unit	User units

EtherNet/IP

Data type	DINT
Access	Get/Set
Instance	1564d / 61Ch
Web server	1564

Service protocol

Read command	E05
Write command	F05+xxxxxxx

Display

Menu	PARAM CHANGE \ POSIT \ OFFSEt
------	-------------------------------

Value range

Value	Display	Description
-999999 ... 999999		
0 (default)		

### 5.1.7 Delta Inch

General characteristics

EEPROM	yes
Class	S
Unit	User units

EtherNet/IP

Data type	DINT
Access	Get/Set
Instance	1553d / 611h
Web server	1553



## Service protocol

Read command	E04
Write command	F04+xxxxxxx

## Display

Menu	PARAM CHANGE \ POSIT \ dInch
------	------------------------------

## Value range

Value	Display	Description
-1000000 ... 1000000		
1024 (default)		

## 5.1.8 Inpos Mode

<b>NOTICE</b>	Is only significant for drives without brake in the positioning operating mode.
---------------	---

## General characteristics

EEPROM	yes
Class	S
Unit	-

## EtherNet/IP

Data type	USINT
Access	Get/Set
Instance	1558d / 616h
Web server	1558

## Service protocol

Read command	G016
Write command	H016xxxxx

## Display

Menu	PARAM CHANGE \ POSIT \ InPOS
------	------------------------------

## Value range

Value	Display	Service protocol	Description
0 (default)	Cntrl	H0160000	Permanent positioning regulation to set point
1	Short	H0160001	Positioning control OFF and short circuit of the motor windings
2	FrEE	H0160002	Positioning control OFF and activation of the drive

### 5.1.9 Pos Type

<b>NOTICE</b>	Loop positioning is executed in the positioning mode only.
---------------	--

#### General characteristics

EEPROM	yes
Class	S
Unit	-

#### EtherNet/IP

Data type	USINT
Access	Get/Set
Instance	1555d / 613h
Web server	1555

#### Service protocol

Read command	-
Write command	Lx

#### Display

Menu	PARAM CHANGE \ POSIT \ PoSTYP
------	-------------------------------

#### Value range

Value	Display	Service protocol	Description
0 (default)	DIRECT	L0	Direct traveling from actual position to target value.
1	POS	L1	Traveling to the target value is always in positive direction to compensate for spindle play.
2	NEG	L2	Traveling to the target value is always in negative direction to compensate for spindle play.

### 5.1.10 Loop Length

#### General characteristics

EEPROM	yes
Class	S
Unit	User units

#### EtherNet/IP

Data type	INT
Access	Get/Set
Instance	1559d / 617h
Web server	1559

## Service protocol

Read command	G017
Write command	H017xxxxx

## Display

Menu	PARAM CHANGE \ POSIT \ LooPLE
------	-------------------------------

## Value range

Value	Display	Description
0 ... 30000		
512 (default)		

### 5.1.11 Calibration Value

## General characteristics

EEPROM	yes
Class	S
Unit	User units

## EtherNet/IP

Data type	DINT
Access	Get/Set
Instance	1550d / 60Eh
Web server	1550

## Service protocol

Read command	E03
Write command	F03+xxxxxxx

## Display

Menu	PARAM CHANGE \ POSIT \ CALVAL
------	-------------------------------

## Value range

Value	Display	Description
-999999 ... 999999		
0 (default)		

### 5.1.12 Control Word

## General characteristics

EEPROM	no
Class	PD
Unit	-

## EtherNet/IP

Data type	UINT
Access	Get/Set
Instance	2d / 2h
Web server	2

## Service protocol

Read command	-
Write command	-

## Display

Menu	-
------	---

## Data type UINT

Value	Display	Description
-		
no default		

## 5.1.13 Status Word

## General characteristics

EEPROM	no
Class	PD
Unit	-

## EtherNet/IP

Data type	UINT
Access	Get
Instance	258d / 102h
Web server	258

## Service protocol

Read command	-
Write command	-

## Display

Menu	-
------	---

## Data type UINT

Value	Display	Description
-		
no default		

### 5.1.14 Target Value

General characteristics

EEPROM	no
Class	PD
Unit	Positioning mode: User units Speed mode: rpm

EtherNet/IP

Data type	DINT
Access	Get/Set
Instance	3d / 3h
Web server	3

Service protocol

Read command	E00
Write command	F00+xxxxxxx

Display

Menu	TARGET
------	--------

Data type DINT

Value	Display	Description
-		
no default		

### 5.1.15 Actual Value

General characteristics

EEPROM	no
Class	PD
Unit	Positioning mode: User units Speed mode: rpm

EtherNet/IP

Data type	DINT
Access	Get
Instance	259d / 103h
Web server	259

Service protocol

Read command	Z
Write command	-

Display

Menu	Line 1
------	--------

Data type DINT

Value	Display	Description
-		
no default		

### 5.1.16 System Status Word

General characteristics

EEPROM	no
Class	-
Unit	-

EtherNet/IP

Data type	UINT
Access	Get
Instance	2572d / A0Ch
Web server	2572

Service protocol

Read command	R
Write command	-

Display

Menu	-
------	---

Data type UINT

Bit	State	Description
Bit 0	0	Irrelevant
Bit 1	0	Irrelevant
Bit 2	0	Irrelevant
Bit 3		<b>Operating mode: Positioning mode: In Position</b>
	1	Actual position is within the positioning window of the programmed target value.
	0	Actual position is outside the positioning window of the programmed target value.
		<b>Operating mode: Speed mode: In Position</b>
	1	Actual speed is inside the specified tolerance window of target speed.
	0	Actual speed is outside the specified tolerance window.
Bit 4		<b>Actuator travels</b>
	1	Actuator travels
	0	Actuator stands still (rotational speed <2 rpm)

Bit	State	Description
Bit 5		<b>Operating mode: Positioning mode: Upper limit</b>
	1	Actual position is above the programmed limiting value. Traveling is possible only in negative direction in inching operation.
	0	Actual position is below the programmed limiting value.
Bit 6		<b>Operating mode: Positioning mode: Lower limit</b>
	1	Actual position is below the programmed limiting value. Traveling is possible only in positive direction in inching operation.
	0	Actual position is above the programmed limiting value.
Bit 7		<b>Driver state:</b>
	1	Motor is activated
	0	Motor in control
Bit 8		<b>Error:</b>
	1	Actuator has switched to error. The cause of the error must be removed and acknowledged.
	0	No error present
Bit 9		<b>Operating mode: Positioning mode: Loop travel</b>
	1	If travel direction unequal start direction (with loop travel).
	0	If travel direction equal start direction.
Bit 10		<b>Output stage operating voltage</b>
	1	No voltage, no travelling possible
	0	Voltage applied
Bit 11		<b>Ready for travel:</b>
	1	Not ready for travel
	0	Ready for travel: Actuator not in error state No active positioning Operating voltage of the output stage is applied Actual position within limits (only positioning mode)
Bit 12	0	Irrelevant
Bit 13		<b>Current limiting:</b>
	1	Current limiting active.
	0	Current limiting not active.
Bit 14		<b>Operating mode: Positioning mode: Status</b>
	1	Positioning active in positioning mode.
	0	Positioning inactive.
		<b>Operating mode: Speed mode: Status</b>
	1	Enable target speed
	0	Target speed disabled

Bit	State	Description
Bit 15		<b>Contouring error:</b>
	1	Contouring error ⇒ the actuator cannot reach the preset speed due to too high load. The actuator switches the contouring error fault. Remedy: reduce programmed speed!
	0	No contouring error ⇒ actual speed corresponds with required speed
no default		

Table 6: System Status Word

The system status word consists of 2 bytes and reflects the state of the drive.

High Byte								Low Byte							
Bit number															
15	14	13	12	11	10	9	8	7	6	5	4	3	2	1	0
0	0	1	0	1	0	0	1	0	1	0	0	1	0	0	0
2				9				4				8			

Fig. 17: Structure of the system status word

Example (gray background):

binary: ⇒ 0010 1001 0100 1000

hex: ⇒ 2 9 4 8

## 5.2 Actuator

### 5.2.1 Operating Mode

General characteristics

EEPROM	yes
Class	S
Unit	-

EtherNet/IP

Data type	USINT
Access	Get/Set
Instance	1556d / 614h
Web server	1556

Service protocol

Read command	-
Write command	X0 / X1



## Display

Menu	PARAM CHANGE \ DRIVE \ OPModE
------	-------------------------------

## Value range

Value	Display	Service protocol	Description
0 (default)	POS	X0	Positioning mode
1	VEL	X1	Speed mode

## 5.2.2 A-Pos

## General characteristics

EEPROM	yes
Class	C
Unit	%, 100 % $\triangleq$ 4 U/s <sup>2</sup>

## EtherNet/IP

Data type	INT
Access	Get/Set
Instance	1540d / 604h
Web server	1540

## Service protocol

Read command	G003
Write command	H003xxxxx

## Display

Menu	PARAM CHANGE \ DRIVE \ A POS
------	------------------------------

## Value range

Value	Display	Description
1 ... 100		
50 (default)		

## 5.2.3 V-Pos

## General characteristics

EEPROM	yes
Class	C
Unit	U/min

## EtherNet/IP

Data type	INT
Access	Get/Set
Instance	1541d / 605h
Web server	1541

## Service protocol

Read command	G004
Write command	H004xxxxx

## Display

Menu	PARAM CHANGE \ DRIVE \ V POS
------	------------------------------

## Value range

Value	Display	Description
i=30.6: 1 ... 150 i=50.0: 1 ... 90 i=70.8: 1 ... 64		
10 (default)		

## 5.2.4 D-Pos

## General characteristics

EEPROM	yes
Class	C
Unit	%, 100 % $\cong$ 4 U/s <sup>2</sup>

## EtherNet/IP

Data type	INT
Access	Get/Set
Instance	1542d / 606h
Web server	1542

## Service protocol

Read command	G044
Write command	H044xxxxx

## Display

Menu	PARAM CHANGE \ DRIVE \ D POS
------	------------------------------

## Value range

Value	Display	Description
1 ... 101		101 % = the delay is determined by the A-Pos parameter.
101 (default)		

### 5.2.5 A-Inch

#### General characteristics

EEPROM	yes
Class	C
Unit	%, 100 % $\cong$ 4 U/s <sup>2</sup>

#### EtherNet/IP

Data type	INT
Access	Get/Set
Instance	1544d / 608h
Web server	1544

#### Service protocol

Read command	G007
Write command	H007xxxxx

#### Display

Menu	PARAM CHANGE \ DRIVE \ A INCH
------	-------------------------------

#### Value range

Value	Display	Description
1 ... 100		
50 (default)		

### 5.2.6 V-Inch

#### General characteristics

EEPROM	yes
Class	C
Unit	rpm

#### EtherNet/IP

Data type	INT
Access	Get/Set
Instance	1545d / 609h
Web server	1545

#### Service protocol

Read command	G008
Write command	H008xxxxx

#### Display

Menu	PARAM CHANGE \ DRIVE \ V INCH
------	-------------------------------

Value range

Value	Display	Description
i=30.6: 1 ... 150 i=50.0: 1 ... 90 i=70.8: 1 ... 64		
10 (default)		

### 5.2.7 Inching 2 Offset

General characteristics

EEPROM	no
Class	S
Unit	%

EtherNet/IP

Data type	USINT
Access	Get/Set
Instance	1562d / 61Ah
Web server	1562

Service protocol

Read command	G027
Write command	H027xxxxx

Display

Menu	PARAM CHANGE \ DRIVE \ OFFIn2
------	-------------------------------

Value range

Value	Display	Description
10 ... 100		
100 (default)		

### 5.2.8 A-Rot

General characteristics

EEPROM	yes
Class	C
Unit	%, 100 % $\triangleq$ 4 U/s <sup>2</sup>

EtherNet/IP

Data type	INT
Access	Get/Set
Instance	1543d / 607h
Web server	1543

Service protocol

Read command	G005
Write command	H005xxxxx

Display

Menu	PARAM CHANGE \ DRIVE \ A ROT
------	------------------------------

Value range

Value	Display	Description
1 ... 100		
50 (default)		

### 5.3 Limiting values

#### 5.3.1 Software Limit 1

General characteristics

EEPROM	yes
Class	S
Unit	User units

EtherNet/IP

Data type	DINT
Access	Get/Set
Instance	1551d / 60Fh
Web server	1551

Service protocol

Read command	E01
Write command	F01±xxxxxxxx

Display

Menu	PARAM CHANGE \ BOUNDS \ SwLIM1
------	--------------------------------

Value range

Value	Display	Description
-2097152 ... 2097151		
999999 (default)		

### 5.3.2 Software Limit 2

General characteristics

EEPROM	yes
Class	S
Unit	User units

EtherNet/IP

Data type	DINT
Access	Get/Set
Instance	1552d / 610h
Web server	1552

Service protocol

Read command	E02
Write command	F02±xxxxxxx

Display

Menu	PARAM CHANGE \ BOUNDS \ SwLIM2
------	--------------------------------

Value range

Value	Display	Description
-2097152 ... 2097151		
-199999 (default)		

### 5.3.3 Peak Current Limit

General characteristics

EEPROM	yes
Class	S
Unit	mA

EtherNet/IP

Data type	INT
Access	Get/Set
Instance	577d / 241h
Web server	577

Service protocol

Read command	G080
Write command	H080xxxxx

Display

Menu	PARAM CHANGE \ BOUNDS \ PKCurL
------	--------------------------------

Value range

Value	Display	Description
0 ... 12000		
12000 (default)		

### 5.3.4 Peak Current Time

General characteristics

EEPROM	yes
Class	S
Unit	x100 ms

EtherNet/IP

Data type	INT
Access	Get/Set
Instance	578d / 242h
Web server	578

Service protocol

Read command	G081
Write command	H081xxxxx

Display

Menu	PARAM CHANGE \ BOUNDS \ PKCurT
------	--------------------------------

Value range

Value	Display	Description
0 ... 40		
40 (default)		

### 5.3.5 Continuous Current

General characteristics

EEPROM	yes
Class	S
Unit	mA

EtherNet/IP

Data type	INT
Access	Get/Set
Instance	579d / 243h
Web server	579

## Service protocol

Read command	G082
Write command	H082xxxxx

## Display

Menu	PARAM CHANGE \ BOUNDS \ CoCurL
------	--------------------------------

## Value range

Value	Display	Description
0 ... 7500		
7500 (default)		

### 5.3.6 Contouring Error Limit

## General characteristics

EEPROM	yes
Class	S
Unit	Steps

## EtherNet/IP

Data type	INT
Access	Get/Set
Instance	1560d / 618h
Web server	1560

## Service protocol

Read command	G018
Write command	H018xxxxx

## Display

Menu	PARAM CHANGE \ BOUNDS \ CoErrL
------	--------------------------------

## Value range

Value	Display	Description
1 ... 30000		
1024 (default)		

### 5.3.7 Travel Against Load Trigger

## General characteristics

EEPROM	yes
Class	S
Unit	mA



## EtherNet/IP

Data type	INT
Access	Get/Set
Instance	2049d / 801h
Web server	2049

## Service protocol

Read command	G070
Write command	H070xxxxx

## Display

Menu	PARAM CHANGE \ BOUNDS \ TALTrG
------	--------------------------------

## Value range

Value	Display	Description
0 ... 7500		
0 (default)		Load approach function deactivated

### 5.3.8 Travel Against Load Direction

## General characteristics

EEPROM	yes
Class	S
Unit	-

## EtherNet/IP

Data type	USINT
Access	Get/Set
Instance	2050d / 802h
Web server	2050

## Service protocol

Read command	G071
Write command	H071xxxxx

## Display

Menu	PARAM CHANGE \ BOUNDS \ TALDir
------	--------------------------------

## Value range

Value	Display	Description
0 (default)	POS	positive sense of rotation
1	NEG	negative sense of rotation

## 5.4 Visualization

### 5.4.1 Display Orientation

General characteristics

EEPROM	yes
Class	V
Unit	-

EtherNet/IP

Data type	USINT
Access	Get/Set
Instance	1795d / 703h
Web server	1795

Service protocol

Read command	G030
Write command	H030xxxxx

Display

Menu	PARAM CHANGE \ VISUAL \ dISP 0
------	--------------------------------

Value range

Value	Display	Description
0 (default)	0	Orientation 0°
1	180	Orientation 180°

### 5.4.2 Display Divisor

Divisor diminishing the display accuracy vs the measurement resolution.

General characteristics

EEPROM	yes
Class	V
Unit	-

EtherNet/IP

Data type	USINT
Access	Get/Set
Instance	1793d / 701h
Web server	1793

Service protocol

Read command	G031
Write command	H031xxxxx

## Display

Menu	PARAM CHANGE \ VISUAL \ DIV
------	-----------------------------

## Value range

Value	Display	Divisor
0 (default)	1	1
1	10	10
2	100	100
3	1000	1000

### 5.4.3 Display Divisor Application

## General characteristics

EEPROM	yes
Class	V
Unit	-

## EtherNet/IP

Data type	USINT
Access	Get/Set
Instance	1794d / 702h
Web server	1794

## Service protocol

Read command	G035
Write command	H035xxxxx

## Display

Menu	PARAM CHANGE \ VISUAL \ DIVAPL
------	--------------------------------

## Value range

Value	Display	Description
0 (default)	ALL	Application to the displayed value and the true value of the target and actual positions.
1	DISPL	Application only to the displayed value of the target and actual positions.

### 5.4.4 Decimal Places

## General characteristics

EEPROM	yes
Class	V
Unit	-

## EtherNet/IP

Data type	USINT
Access	Get/Set
Instance	1796d / 704h
Web server	1796

## Service protocol

Read command	G032
Write command	H032xxxxx

## Display

Menu	PARAM CHANGE \ VISUAL \ dECI P
------	--------------------------------

## Value range

Value	Display	Number of decimal place
0 (default)	0	0
1	0.1	1
2	0.02	2
3	0.003	3
4	0.0004	4

### 5.4.5 Direction Indication Function

## General characteristics

EEPROM	yes
Class	V
Unit	-

## EtherNet/IP

Data type	USINT
Access	Get/Set
Instance	1797d / 705h
Web server	1797

## Service protocol

Read command	G033
Write command	H033xxxxx

## Display

Menu	PARAM CHANGE \ VISUAL \ IndIcF
------	--------------------------------

Value range

Value	Display	Description
0 (default)	ON	On
1	InVErt	inverted
2	OFF	Off

#### 5.4.6 Displayed Value 2nd Line

General characteristics

EEPROM	yes
Class	V
Unit	-

EtherNet/IP

Data type	USINT
Access	Get/Set
Instance	1798d / 706h
Web server	1798

Service protocol

Read command	G043
Write command	H043xxxxx

Display

Menu	PARAM CHANGE \ VISUAL \ LinE2
------	-------------------------------

Value range

Value	Display	Description	Chapter
0 (default)	TARGET	Target Value	<a href="#">5.1.14</a>
1	OS DEG	Output Stage Temperature	<a href="#">5.9.1</a>
2	VM DEG	Virtual Motor Temperature	<a href="#">5.9.2</a>
3	C VOLT	Voltage of Control	<a href="#">5.9.3</a>
4	P VOLT	Voltage of Output Stage	<a href="#">5.9.4</a>
5	MotCur	Motor Current	<a href="#">5.9.5</a>
6	POS	Actual Position	<a href="#">5.9.6</a>
7	VEL	Actual Rotational Speed	<a href="#">5.9.7</a>
8	OVLOAD	Overload	<a href="#">5.9.8</a>
9	ConErr	Actual Contouring Error	<a href="#">5.9.9</a>

## 5.5 Options

### 5.5.1 Key Enable Time

General characteristics

EEPROM	yes
Class	V
Unit	s

EtherNet/IP

Data type	USINT
Access	Get/Set
Instance	1799d / 707h
Web server	1799

Service protocol

Read command	G029
Write command	H029xxxxx

Display

Menu	PARAM CHANGE \ OPTION \ CdELAY
------	--------------------------------

Value range

Value	Display	Description
1 ... 60		
3 (default)		

### 5.5.2 Key Function Enable

General characteristics

EEPROM	yes
Class	V
Unit	-

EtherNet/IP

Data type	USINT
Access	Get/Set
Instance	1800d / 708h
Web server	1800

Service protocol

Read command	G028
Write command	H028xxxxx

## Display

Menu	PARAM CHANGE \ OPTION \ bUTTON
------	--------------------------------

## Value range

Value	Display	Description
0 (default)	ON	All functions enabled via key
1	OFF	All functions disabled via key

### 5.5.3 Inching 2 Acceleration Type

The acceleration type in Inching operation 2 can be influenced via this parameter.

## General characteristics

EEPROM	yes
Class	S
Unit	-

## EtherNet/IP

Data type	USINT
Access	Get/Set
Instance	1563d / 61Bh
Web server	1563

## Service protocol

Read command	G039
Write command	H039xxxxx

## Display

Menu	PARAM CHANGE \ OPTION \ AccTYP
------	--------------------------------

## Value range

Value	Display	Description
0 (default)	StAt	Static acceleration Acceleration occurs to final speed as defined under parameter A-Inch (see chapter 5.2.5).
1	dYN	Incremental acceleration Acceleration occurs to final speed as defined under parameter A-Inch (see chapter 5.2.5) with the following increments: 4 s to 20 % of final speed 2 s to 50 % of final speed 1 s to 100 % of final speed

### 5.5.4 Inching 2 Stop Mode

The delay ramp in Inching operation 2 can be influenced via this parameter.

General characteristics

EEPROM	yes
Class	S
Unit	-

EtherNet/IP

Data type	USINT
Access	Get/Set
Instance	1557d / 615h
Web server	1557

Service protocol

Read command	G015
Write command	H015xxxxx

Display

Menu	PARAM CHANGE \ OPTION \ StoP2
------	-------------------------------

Value range

Value	Display	Description
0 (default)	HARd	Stop with maximum delay
1	SOFT	Stop with programmed delay

### 5.5.5 PIN Change

Required PIN to enable changing of parameters via keys and display.

General characteristics

EEPROM	yes
Class	V
Unit	-

EtherNet/IP

Data type	DINT
Access	Get/Set
Instance	1801d / 709h
Web server	1801

Service protocol

Read command	G041
Write command	H041xxxxx



## Display

Menu	PARAM CHANGE \ OPTION \ PIN
------	-----------------------------

## Value range

Value	Display	Description
0 ... 99999		
0 (default)		

### 5.5.6 Generic Mapping Parameter

This parameter defines the content of the Generic Mapping Channel, which is a component of the process data.

## General characteristics

EEPROM	yes
Class	N
Unit	-

## EtherNet/IP

Data type	USINT
Access	Get/Set
Instance	546d / 222h
Web server	546

## Service protocol

Read command	G160
Write command	H160xxxxx

## Display

Menu	PARAM CHANGE \ OPTION \ GENMAP
------	--------------------------------

## Value range

Value	Display	Description	Chapter
0 (default)	TARGET	Target Value	<a href="#">5.1.14</a>
1	OS DEG	Output Stage Temperature	<a href="#">5.9.1</a>
2	VM DEG	Virtual Motor Temperature	<a href="#">5.9.2</a>
3	C VOLT	Voltage of Control	<a href="#">5.9.3</a>
4	P VOLT	Voltage of Output Stage	<a href="#">5.9.4</a>
5	MotCur	Motor Current	<a href="#">5.9.5</a>
6	POS	Actual Position	<a href="#">5.9.6</a>
7	VEL	Actual Rotational Speed	<a href="#">5.9.7</a>
8	OVLOAD	Overload	<a href="#">5.9.8</a>
9	ConErr	Actual Contouring Error	<a href="#">5.9.9</a>
10	ERROR	Actual Error	<a href="#">3.3.2.1</a>

### 5.5.7 Configuration

This parameter configures various functions of the actuator.

General characteristics

EEPROM	yes
Class	S
Unit	-

EtherNet/IP

Data type	UINT
Access	Get/Set
Instance	2849d / B21h
Web server	2849

Service protocol

Read command	G061
Write command	H061xxxxx

Display

Menu	PARAM CHANGE \ OPTION \ CONFIG
------	--------------------------------

Value range

Bit	Description
0	SHICP (Secure Host IP Configuration Protocol) 0 = switched off 1 = switched on (default) Changes are only adopted after reset.
1	Web server 0 = switched off 1 = switched on (default) Changes are only adopted after reset.
2	Parameter access via web server 0 = switched off 1 = switched on (default) Changes are only adopted after reset.
3	FTP Server 0 = switched off 1 = switched on (default) Changes are only adopted after reset.
4	FTP Server administrator rights 0 = no (default) 1 = yes Changes are only adopted after reset.
5	Reserved, always 0

Bit	Description
6	Auto reset in the EXCEPTION state 0 = switched off (default): In the EXCEPTION state, the drive stops participating in network traffic and can no longer be addressed. To exit this state, a Power On Reset is required. 1 = switched on: In the EXCEPTION state, the drive automatically performs a reset. After the restart, the EXCEPTION fault is triggered.
7 ... 15	Reserved, always 0

### 5.5.8 S-Command

#### General characteristics

EEPROM	no
Class	-
Unit	-

#### EtherNet/IP

Data type	USINT
Access	Get/Set
Instance	3073d / C01h
Web server	3073

#### Service protocol

Read command	-
Write command	Sxxxxx / K

#### Display

Menu	PARAM CHANGE \ OPTION \ LOAdP
------	-------------------------------

#### Value range

Value	Display	Service protocol	Description
0	NO	-	No function
1	ALL	S11100	Reset all parameters (C, N, S, and V) to factory settings
2	StAnd	S11101	Reset only standard parameters (Class S) to factory settings
3	CONTR	S11102	Reset only controller parameters (Class C) to factory settings
4	VISUAL	S11003	Reset only visualization parameters (Class V) to factory settings
5	NETW	S11004	Reset only network parameters (Class N) to factory settings
6	AckErr	S11103	Acknowledge error
7	CALIB	S11104	Calibrate
8	dLErr	S11105	Delete error memory (Class E)

Value	Display	Service protocol	Description
9	RESET	K	Execute soft start
no default			

## 5.6 Controller parameter

### 5.6.1 Controller Parameter P

The setting applies to all operating modes.

General characteristics

EEPROM	yes
Class	C
Unit	-

EtherNet/IP

Data type	INT
Access	Get/Set
Instance	1537d / 601h
Web server	1537

Service protocol

Read command	G000
Write command	H000xxxxx

Display

Menu	PARAM CHANGE \ CONTR \ CPAr P
------	-------------------------------

Value range

Value	Display	Description
1 ... 500		
300 (default)		

### 5.6.2 Controller Parameter I

The setting applies to all operating modes.

General characteristics

EEPROM	yes
Class	C
Unit	-

## EtherNet/IP

Data type	INT
Access	Get/Set
Instance	1538d / 602h
Web server	1538

## Service protocol

Read command	G001
Write command	H001xxxxx

## Display

Menu	PARAM CHANGE \ CONTR \ CPAr I
------	-------------------------------

## Value range

Value	Display	Description
0 ... 500		
2 (default)		

### 5.6.3 Controller Parameter D

The setting applies to all operating modes.

## General characteristics

EEPROM	yes
Class	C
Unit	-

## EtherNet/IP

Data type	INT
Access	Get/Set
Instance	1539d / 603h
Web server	1539

## Service protocol

Read command	G002
Write command	H002xxxxx

## Display

Menu	PARAM CHANGE \ CONTR \ CPAr D
------	-------------------------------

## Value range

Value	Display	Description
0 ... 500		
0 (default)		

## 5.7 Digital input/output

### 5.7.1 Digital Input 1 Functionality

This parameter determines the functionality of digital input 1.

With a value greater than 0 set, a function is assigned to the digital input.

The functional state can be read from the Digital Input Functionalities State register.

General characteristics

EEPROM	yes
Class	S
Unit	-

EtherNet/IP

Data type	USINT
Access	Get/Set
Instance	1025d / 401h
Web server	1025

Service protocol

Read command	G049
Write command	H049xxxxx

Display

Menu	PARAM CHANGE \ DIG IO \ F DI 1
------	--------------------------------

Value range

Value	Display	Description
0 (default)	GENEPL	General use No function is assigned to the digital input.
1	LIMSw1	Limit switch 1
2	LIMSw2	Limit switch 2
3	INch2P	Inching operation 2 positive direction
4	INch2N	Inching operation 2 negative direction
5	CALib	Calibrate
6	AckErr	Acknowledge error
7	INch1	Inching operation 1, direction as programmed
8	PCMAbS	PCM Start absolute
9	PCMIN1	PCM input 1
10	PCMIN2	PCM input 2
11	PCMIN3	PCM input 3
12	INch1P	Inching operation 1 positive direction
13	INch1N	Inching operation 1 negative direction
14	PCMREL	PCM Start relative
15	RESET	Run warm start

Table 7: Configuration of digital inputs

### 5.7.2 Digital Input 2 Functionality

This parameter determines the functionality of digital input 2.

With a value greater than 0 set, a function is assigned to the digital input.

The functional state can be read from the Digital Input Functionalities State register.

General characteristics

EEPROM	yes
Class	S
Unit	-

EtherNet/IP

Data type	USINT
Access	Get/Set
Instance	1026d / 402h
Web server	1026

Service protocol

Read command	G050
Write command	H050xxxxx

Display

Menu	PARAM CHANGE \ DIG IO \ F DI 2
------	--------------------------------

Value range

Value	Display	Description
0 ... 15		
0 (default)		

Description, see [Table 7](#).

### 5.7.3 Digital Input 3 Functionality

This parameter determines the functionality of digital input 3.

With a value greater than 0 set, a function is assigned to the digital input.

The functional state can be read from the Digital Input Functionalities State register.

General characteristics

EEPROM	yes
Class	S
Unit	-

EtherNet/IP

Data type	USINT
-----------	-------

Access	Get/Set
Instance	1027d / 403h
Web server	1027

Service protocol

Read command	G051
Write command	H051xxxxx

Display

Menu	PARAM CHANGE \ DIG IO \ F DI 3
------	--------------------------------

Value range

Value	Display	Description
0 ... 15		
0 (default)		

Description, see [Table 7](#).

#### 5.7.4 Digital Input 4 Functionality

This parameter determines the functionality of digital input 4.

With a value greater than 0 set, a function is assigned to the digital input.

The functional state can be read from the Digital Input Functionalities State register.

General characteristics

EEPROM	yes
Class	S
Unit	-

EtherNet/IP

Data type	USINT
Access	Get/Set
Instance	1028d / 404h
Web server	1028

Service protocol

Read command	G052
Write command	H052xxxxx

Display

Menu	PARAM CHANGE \ DIG IO \ F DI 4
------	--------------------------------

Value range

Value	Display	Description
0 ... 15		
0 (default)		

Description, see [Table 7](#).



### 5.7.5 Digital Inputs Polarity

This parameter determines the switching behavior individually for every digital input. A bit that defines the switching logics is assigned to every digital input.

General characteristics

EEPROM	yes
Class	S
Unit	-

EtherNet/IP

Data type	USINT
Access	Get/Set
Instance	1030d / 406h
Web server	1030

Service protocol

Read command	G054
Write command	H054xxxxx

Value range

Bit	Menu	Description
0	PARAM CHANGE \ DIG IO \ P DI 1	Digital input 1 polarity
1	PARAM CHANGE \ DIG IO \ P DI 2	Digital input 2 polarity
2	PARAM CHANGE \ DIG IO \ P DI 3	Digital input 3 polarity
3	PARAM CHANGE \ DIG IO \ P DI 4	Digital input 4 polarity
4 ... 7		Not assigned

Bit-Wert	Display	Description
0 (default)	HIGH	positive logics
1	LOW	negative logics

### 5.7.6 Digital Input Functionalities State

The states of the digital inputs are mapped in this register according to the functionalities set. A bit is assigned to every function.

General characteristics

EEPROM	no
Class	-
Unit	-

EtherNet/IP

Data type	UDINT
Access	Get

Instance	1029d / 405h
Web server	1029

Service protocol

Read command	U1029
Write command	-

Display

Menu	-
------	---

Value range

Bit	Description
0	Limit switch 1
1	Limit switch 2
2	Inching operation 2 positive direction
3	Inching operation 2 negative direction
4	Calibrate
5	Acknowledge error
6	Inching operation 1, direction as programmed
7	PCM Start absolute
8	PCM input 1
9	PCM input 2
10	PCM input 3
11	Inching operation 1 positive direction
12	Inching operation 1 negative direction
13	PCM Start relative
14	Execute soft start
15 ... 31	Not assigned
no default	

Table 8: States of the digital inputs

### 5.7.7 Digital Inputs State

General characteristics

Default	no
EEPROM	no
Class	PD
Unit	-

EtherNet/IP

Data type	UINT
Access	Get
Instance	257d / 101h
Web server	257

## Service protocol

Read command	B005 (Decimal notation)
Write command	-

## Display

Menu	PARAM RoPARA \ DI4321
------	-----------------------

## Data type UINT

Bit	Description
0	State of digital input 1
1	State of digital input 2
2	State of digital input 3
3	State of digital input 4
4 ... 15	Not assigned
no default	

### 5.7.8 Digital Output 1 Functionality

This parameter determines the function of digital output 1.

This setting determines the bit position in the Digital Outputs Status register, which governs the state of the digital output.

## General characteristics

EEPROM	yes
Class	S
Unit	-

## EtherNet/IP

Data type	USINT
Access	Get/Set
Instance	769d / 301h
Web server	769

## Service protocol

Read command	G046
Write command	H046xxxxx

## Display

Menu	PARAM CHANGE \ DIG IO \ F DO 1
------	--------------------------------

## Value range

Value	Display	Description
0 (default)	GENEERL	General use Control of the control output is directly via bit D01 in the process data.
1	FAULT	The output is switched active in case of fault.

Value	Display	Description
2	INPOS	The state of bit Inpos in the status word defines the state of the digital output.
3	ON	The output is switched on permanently.
4	OP EN	The output is active in the Operation enabled status.
5	NOTMOV	Drive is idle

### 5.7.9 Digital Outputs Polarity

This parameter determines the switching behavior individually for every digital output. A bit that defines the switching logics is assigned to every digital output.

General characteristics

EEPROM	yes
Class	S
Unit	-

EtherNet/IP

Data type	USINT
Access	Get/Set
Instance	771d / 303h
Web server	771

Service protocol

Read command	G048
Write command	H048xxxxx

Value range

Bit	Menu	Description
0	PARAM CHANGE \ DIG IO \ P DO 1	Digital output 1 polarity
1 ... 7		Not assigned

Bit value	Display	Description
0 (default)	HIGH	positive logics
1	LOW	negative logics

### 5.7.10 Digital Output Functionalities State

The functional states that can be assigned to the digital output can be read from this register.

General characteristics

EEPROM	no
Class	-

Unit	-
------	---

## EtherNet/IP

Data type	UDINT
Access	Get
Instance	770d / 302h
Web server	770

## Service protocol

Read command	U0770
Write command	-

## Display

Menu	-
------	---

## Value range

Bit	Description
0	Error 0 = no error 1 = error active
1	Inpos 0 = actual value outside the positioning window 1 = actual value inside the positioning window
2	Output on The bit is permanently set.
3	Operation enabled 0 = operation not enabled 1 = operation enabled
4	Drive stands still 0 = Drive does not stand still 1 = drive stands still
5 ... 31	Not assigned
no default	

### 5.7.11 Digital Outputs Control

## General characteristics

EEPROM	no
Class	PD
Unit	-

## EtherNet/IP

Data type	UINT
Access	Get/Set
Instance	1d / 1h
Web server	1

## Service protocol

Read command	G060
Write command	H060xxxxx

## Display

Menu	-
------	---

## Value range

Bit	Description
0	Digital output 1
1 ... 15	Reserved, always 0
no default	

### 5.7.12 Service Interface Baud Rate

## General characteristics

EEPROM	yes
Class	S
Unit	-

## EtherNet/IP

Data type	USINT
Access	Get/Set
Instance	545d / 221h
Web server	545

## Service protocol

Read command	G025
Write command	H025xxxxx

## Display

Menu	PARAM CHANGE \ DIG IO \ BAUD
------	------------------------------

## Value range

Value	Display	Description
0	19.2	19.2 kBit/s
1 (default)	57.6	57.6 kBit/s
2	115.2	115.2 kBit/s
3	9.6	9.6 kBit/s

## 5.8 Position Control Mode

### 5.8.1 PCM Position 1

General characteristics

EEPROM	yes
Class	S
Unit	User units

EtherNet/IP

Data type	DINT
Access	Get/Set
Instance	2338d / 922h
Web server	2338

Service protocol

Read command	E10
Write command	F10+xxxxxxx

Display

Menu	PARAM CHANGE \ PCM \ PCM SET 1 \ POS 1
------	--

Value range

Value	Display	Description
-2097152 ... 2097151		
0 (default)		

### 5.8.2 PCM Position 2

General characteristics

EEPROM	yes
Class	S
Unit	User units

EtherNet/IP

Data type	DINT
Access	Get/Set
Instance	2339d / 923h
Web server	2339

Service protocol

Read command	E11
Write command	F11+xxxxxxx

Display

Menu	PARAM CHANGE \ PCM \ PCM SET 2 \ POS 2
------	--

Value range

Value	Display	Description
-2097152 ... 2097151		
0 (default)		

### 5.8.3 PCM Position 3

General characteristics

EEPROM	yes
Class	S
Unit	User units

EtherNet/IP

Data type	DINT
Access	Get/Set
Instance	2340d / 924h
Web server	2340

Service protocol

Read command	E12
Write command	F12+xxxxxxx

Display

Menu	PARAM CHANGE \ PCM \ PCM SET 3 \ POS 3
------	--

Value range

Value	Display	Description
-2097152 ... 2097151		
0 (default)		

### 5.8.4 PCM Position 4

General characteristics

EEPROM	yes
Class	S
Unit	User units

EtherNet/IP

Data type	DINT
Access	Get/Set
Instance	2341d / 925h



Web server	2341
------------	------

Service protocol

Read command	E13
Write command	F13+xxxxxxx

Display

Menu	PARAM CHANGE \ PCM \ PCM SET 4 \ POS 4
------	--

Value range

Value	Display	Description
-2097152 ... 2097151		
0 (default)		

### 5.8.5 PCM Position 5

General characteristics

EEPROM	yes
Class	S
Unit	User units

EtherNet/IP

Data type	DINT
Access	Get/Set
Instance	2342d / 926h
Web server	2342

Service protocol

Read command	E14
Write command	F14+xxxxxxx

Display

Menu	PARAM CHANGE \ PCM \ PCM SET 5 \ POS 5
------	--

Value range

Value	Display	Description
-2097152 ... 2097151		
0 (default)		

### 5.8.6 PCM Position 6

General characteristics

EEPROM	yes
Class	S

Unit	User units
------	------------

## EtherNet/IP

Data type	DINT
Access	Get/Set
Instance	2343d / 927h
Web server	2343

## Service protocol

Read command	E15
Write command	F15+xxxxxxx

## Display

Menu	PARAM CHANGE \ PCM \ PCM SET 6 \ POS 6
------	--

## Value range

Value	Display	Description
-2097152 ... 2097151		
0 (default)		

### 5.8.7 PCM Position 7

## General characteristics

EEPROM	yes
Class	S
Unit	User units

## EtherNet/IP

Data type	DINT
Access	Get/Set
Instance	2344d / 928h
Web server	2344

## Service protocol

Read command	E16
Write command	F16+xxxxxxx

## Display

Menu	PARAM CHANGE \ PCM \ PCM SET 7 \ POS 7
------	--

## Value range

Value	Display	Description
-2097152 ... 2097151		
0 (default)		

### 5.8.8 PCM Acceleration 1

General characteristics

EEPROM	yes
Class	S
Unit	%, 100 % $\cong$ 4 U/s <sup>2</sup>

EtherNet/IP

Data type	INT
Access	Get/Set
Instance	2370d / 942h
Web server	2370

Service protocol

Read command	G100
Write command	H100xxxxx

Display

Menu	PARAM CHANGE \ PCM \ PCM SET 1 \ ACC 1
------	--

Value range

Value	Display	Description
1 ... 100		
50 (default)		

### 5.8.9 PCM Acceleration 2

General characteristics

EEPROM	yes
Class	S
Unit	%, 100 % $\cong$ 4 U/s <sup>2</sup>

EtherNet/IP

Data type	INT
Access	Get/Set
Instance	2371d / 943h
Web server	2371

Service protocol

Read command	G101
Write command	H101xxxxx

Display

Menu	PARAM CHANGE \ PCM \ PCM SET 2 \ ACC 2
------	--

Value range

Value	Display	Description
1 ... 100		
50 (default)		

### 5.8.10 PCM Acceleration 3

General characteristics

EEPROM	yes
Class	S
Unit	%, 100 % $\cong$ 4 U/s <sup>2</sup>

EtherNet/IP

Data type	INT
Access	Get/Set
Instance	2372d / 944h
Web server	2372

Service protocol

Read command	G102
Write command	H102xxxxx

Display

Menu	PARAM CHANGE \ PCM \ PCM SET 3 \ ACC 3
------	--

Value range

Value	Display	Description
1 ... 100		
50 (default)		

### 5.8.11 PCM Acceleration 4

General characteristics

EEPROM	yes
Class	S
Unit	%, 100 % $\cong$ 4 U/s <sup>2</sup>

EtherNet/IP

Data type	INT
Access	Get/Set
Instance	2373d / 945h
Web server	2373

## Service protocol

Read command	G103
Write command	H103xxxxx

## Display

Menu	PARAM CHANGE \ PCM \ PCM SET 4 \ ACC 4
------	--

## Value range

Value	Display	Description
1 ... 100		
50 (default)		

**5.8.12 PCM Acceleration 5**

## General characteristics

EEPROM	yes
Class	S
Unit	%, 100 % $\triangleq$ 4 U/s <sup>2</sup>

## EtherNet/IP

Data type	INT
Access	Get/Set
Instance	2374d / 946h
Web server	2374

## Service protocol

Read command	G104
Write command	H104xxxxx

## Display

Menu	PARAM CHANGE \ PCM \ PCM SET 5 \ ACC 5
------	--

## Value range

Value	Display	Description
1 ... 100		
50 (default)		

**5.8.13 PCM Acceleration 6**

## General characteristics

EEPROM	yes
Class	S
Unit	%, 100 % $\triangleq$ 4 U/s <sup>2</sup>

## EtherNet/IP

Data type	INT
Access	Get/Set
Instance	2375d / 947h
Web server	2375

## Service protocol

Read command	G105
Write command	H105xxxxx

## Display

Menu	PARAM CHANGE \ PCM \ PCM SET 6 \ ACC 6
------	--

## Value range

Value	Display	Description
1 ... 100		
50 (default)		

## 5.8.14 PCM Acceleration 7

## General characteristics

EEPROM	yes
Class	S
Unit	%, 100 % $\cong$ 4 U/s <sup>2</sup>

## EtherNet/IP

Data type	INT
Access	Get/Set
Instance	2376d / 948h
Web server	2376

## Service protocol

Read command	G106
Write command	H106xxxxx

## Display

Menu	PARAM CHANGE \ PCM \ PCM SET 7 \ ACC 7
------	--

## Value range

Value	Display	Description
1 ... 100		
50 (default)		

**5.8.15 PCM Velocity 1**

## General characteristics

EEPROM	yes
Class	S
Unit	rpm

## EtherNet/IP

Data type	INT
Access	Get/Set
Instance	2402d / 962h
Web server	2402

## Service protocol

Read command	G120
Write command	H120xxxxx

## Display

Menu	PARAM CHANGE \ PCM \ PCM SET 1 \ VEL 1
------	--

## Value range

Value	Display	Description
i=30.6: 1 ... 150		
i=50.0: 1 ... 90		
i=70.8: 1 ... 64		
10 (default)		

**5.8.16 PCM Velocity 2**

## General characteristics

EEPROM	yes
Class	S
Unit	rpm

## EtherNet/IP

Data type	INT
Access	Get/Set
Instance	2403d / 963h
Web server	2403

## Service protocol

Read command	G121
Write command	H121xxxxx

## Display

Menu	PARAM CHANGE \ PCM \ PCM SET 2 \ VEL 2
------	--

Value range

Value	Display	Description
i=30.6: 1 ... 150 i=50.0: 1 ... 90 i=70.8: 1 ... 64		
10 (default)		

### 5.8.17 PCM Velocity 3

General characteristics

EEPROM	yes
Class	S
Unit	rpm

EtherNet/IP

Data type	INT
Access	Get/Set
Instance	2404d / 964h
Web server	2404

Service protocol

Read command	G122
Write command	H122xxxxx

Display

Menu	PARAM CHANGE \ PCM \ PCM SET 3 \ VEL 3
------	--

Value range

Value	Display	Description
i=30.6: 1 ... 150 i=50.0: 1 ... 90 i=70.8: 1 ... 64		
10 (default)		

### 5.8.18 PCM Velocity 4

General characteristics

EEPROM	yes
Class	S
Unit	rpm

EtherNet/IP

Data type	INT
Access	Get/Set



Instance	2405d / 965h
Web server	2405

Service protocol

Read command	G123
Write command	H123xxxxx

Display

Menu	PARAM CHANGE \ PCM \ PCM SET 4 \ VEL 4
------	--

Value range

Value	Display	Description
i=30.6: 1 ... 150		
i=50.0: 1 ... 90		
i=70.8: 1 ... 64		
10 (default)		

### 5.8.19 PCM Velocity 5

General characteristics

EEPROM	yes
Class	S
Unit	rpm

EtherNet/IP

Data type	INT
Access	Get/Set
Instance	2406d / 966h
Web server	2406

Service protocol

Read command	G124
Write command	H124xxxxx

Display

Menu	PARAM CHANGE \ PCM \ PCM SET 5 \ VEL 5
------	--

Value range

Value	Display	Description
i=30.6: 1 ... 150		
i=50.0: 1 ... 90		
i=70.8: 1 ... 64		
10 (default)		

**5.8.20 PCM Velocity 6**

## General characteristics

EEPROM	yes
Class	S
Unit	rpm

## EtherNet/IP

Data type	INT
Access	Get/Set
Instance	2407d / 967h
Web server	2407

## Service protocol

Read command	G125
Write command	H125xxxxx

## Display

Menu	PARAM CHANGE \ PCM \ PCM SET 6 \ VEL 6
------	--

## Value range

Value	Display	Description
i=30.6: 1 ... 150		
i=50.0: 1 ... 90		
i=70.8: 1 ... 64		
10 (default)		

**5.8.21 PCM Velocity 7**

## General characteristics

EEPROM	yes
Class	S
Unit	rpm

## EtherNet/IP

Data type	INT
Access	Get/Set
Instance	2408d / 968h
Web server	2408

## Service protocol

Read command	G126
Write command	H126xxxxx

## Display

Menu	PARAM CHANGE \ PCM \ PCM SET 7 \ VEL 7
------	--

Value range

Value	Display	Description
i=30.6: 1 ... 150 i=50.0: 1 ... 90 i=70.8: 1 ... 64		
10 (default)		

### 5.8.22 PCM Deceleration 1

General characteristics

EEPROM	yes
Class	S
Unit	%, 100 % $\cong$ 4 U/s <sup>2</sup>

EtherNet/IP

Data type	INT
Access	Get/Set
Instance	2434d / 982h
Web server	2434

Service protocol

Read command	G140
Write command	H140xxxxx

Display

Menu	PARAM CHANGE \ PCM \ PCM SET 1 \ DEC 1
------	--

Value range

Value	Display	Description
1 ... 101		101 % = the delay is determined by the PCM Acceleration 1 parameter.
101 (default)		

### 5.8.23 PCM Deceleration 2

General characteristics

EEPROM	yes
Class	S
Unit	%, 100 % $\cong$ 4 U/s <sup>2</sup>

EtherNet/IP

Data type	INT
Access	Get/Set
Instance	2435d / 983h

Web server	2435
------------	------

Service protocol

Read command	G141
Write command	H141xxxxx

Display

Menu	PARAM CHANGE \ PCM \ PCM SET 2 \ DEC 2
------	--

Value range

Value	Display	Description
1 ... 101		101 % = the delay is determined by the PCM Acceleration 2 parameter.
101 (default)		

### 5.8.24 PCM Deceleration 3

General characteristics

EEPROM	yes
Class	S
Unit	%, 100 % $\cong$ 4 U/s <sup>2</sup>

EtherNet/IP

Data type	INT
Access	Get/Set
Instance	2436d / 984h
Web server	2436

Service protocol

Read command	G142
Write command	H142xxxxx

Display

Menu	PARAM CHANGE \ PCM \ PCM SET 3 \ DEC 3
------	--

Value range

Value	Display	Description
1 ... 101		101 % = the delay is determined by the PCM Acceleration 3 parameter.
101 (default)		

### 5.8.25 PCM Deceleration 4

General characteristics

EEPROM	yes
--------	-----

Class	S
Unit	%, 100 % $\cong$ 4 U/s <sup>2</sup>

## EtherNet/IP

Data type	INT
Access	Get/Set
Instance	2437d / 985h
Web server	2437

## Service protocol

Read command	G143
Write command	H143xxxxx

## Display

Menu	PARAM CHANGE \ PCM \ PCM SET 4 \ DEC 4
------	--

## Value range

Value	Display	Description
1 ... 101		101 % = the delay is determined by the PCM Acceleration 4 parameter.
101 (default)		

## 5.8.26 PCM Deceleration 5

## General characteristics

EEPROM	yes
Class	S
Unit	%, 100 % $\cong$ 4 U/s <sup>2</sup>

## EtherNet/IP

Data type	INT
Access	Get/Set
Instance	2438d / 986h
Web server	2438

## Service protocol

Read command	G144
Write command	H144xxxxx

## Display

Menu	PARAM CHANGE \ PCM \ PCM SET 5 \ DEC 5
------	--

## Value range

Value	Display	Description
1 ... 101		101 % = the delay is determined by the PCM Acceleration 5 parameter.

Value	Display	Description
101 (default)		

### 5.8.27 PCM Deceleration 6

General characteristics

EEPROM	yes
Class	S
Unit	%, 100 % $\cong$ 4 U/s <sup>2</sup>

EtherNet/IP

Data type	INT
Access	Get/Set
Instance	2439d / 987h
Web server	2439

Service protocol

Read command	G145
Write command	H145xxxxx

Display

Menu	PARAM CHANGE \ PCM \ PCM SET 6 \ DEC 6
------	--

Value range

Value	Display	Description
1 ... 101		101 % = the delay is determined by the PCM Acceleration 6 parameter.
101 (default)		

### 5.8.28 PCM Deceleration 7

General characteristics

EEPROM	yes
Class	S
Unit	%, 100 % $\cong$ 4 U/s <sup>2</sup>

EtherNet/IP

Data type	INT
Access	Get/Set
Instance	2440d / 988h
Web server	2440

Service protocol

Read command	G146
--------------	------

Write command	H146xxxxx
---------------	-----------

Display

Menu	PARAM CHANGE \ PCM \ PCM SET 7 \ DEC 7
------	--

Value range

Value	Display	Description
1 ... 101		101 % = the delay is determined by the PCM Acceleration 7 parameter.
101 (default)		

## 5.9 Device information

### 5.9.1 Output Stage Temperature

General characteristics

EEPROM	no
Class	-
Unit	1/10 °C

EtherNet/IP

Data type	INT
Access	Get
Instance	2561d / A01h
Web server	2561

Service protocol

Read command	B000
Write command	-

Display

Menu	PARAM RoPARA \ OS DEG
------	-----------------------

Value range

Value	Display	Description
-		
no default		

### 5.9.2 Virtual Motor Temperature

Motor temperature based on a 2<sup>nd</sup> order thermal model.

General characteristics

EEPROM	no
--------	----

Class	-
Unit	1/10 °C

## EtherNet/IP

Data type	INT
Access	Get
Instance	2575d / A0Fh
Web server	2575

## Service protocol

Read command	B007
Write command	-

## Display

Menu	PARAM RoPARA \ VM DEG
------	-----------------------

## Value range

Value	Display	Description
-		
no default		

### 5.9.3 Voltage of Control

## General characteristics

EEPROM	no
Class	-
Unit	1/10 V

## EtherNet/IP

Data type	INT
Access	Get
Instance	2562d / A02h
Web server	2562

## Service protocol

Read command	B001
Write command	-

## Display

Menu	PARAM RoPARA \ C VOLT
------	-----------------------

## Value range

Value	Display	Description
-		
no default		



### 5.9.4 Voltage of Output Stage

General characteristics

EEPROM	no
Class	-
Unit	1/10 V

EtherNet/IP

Data type	INT
Access	Get
Instance	2563d / A03h
Web server	2563

Service protocol

Read command	B002
Write command	-

Display

Menu	PARAM RoPARA \ P VOLT
------	-----------------------

Value range

Value	Display	Description
-		
no default		

### 5.9.5 Motor Current

General characteristics

EEPROM	no
Class	-
Unit	mA

EtherNet/IP

Data type	INT
Access	Get
Instance	2565d / A05h
Web server	2565

Service protocol

Read command	B004
Write command	-

Display

Menu	PARAM RoPARA \ MotCur
------	-----------------------

Value range

Value	Display	Description
-		
no default		

### 5.9.6 Actual Position

General characteristics

EEPROM	no
Class	-
Unit	User units

EtherNet/IP

Data type	DINT
Access	Get
Instance	2566d / A06h
Web server	2566

Service protocol

Read command	Z
Write command	-

Display

Menu	PARAM RoPARA \ POS
------	--------------------

Value range

Value	Display	Description
-		
no default		

### 5.9.7 Actual Rotational Speed

General characteristics

EEPROM	no
Class	-
Unit	rpm

EtherNet/IP

Data type	INT
Access	Get
Instance	2567d / A07h
Web server	2567

## Service protocol

Read command	V
Write command	-

## Display

Menu	PARAM RoPARA \ VEL
------	--------------------

## Value range

Value	Display	Description
-		
no default		

## 5.9.8 Overload

## General characteristics

EEPROM	no
Class	-
Unit	%

## EtherNet/IP

Data type	USINT
Access	Get
Instance	2576d / A10h
Web server	2576

## Service protocol

Read command	B008
Write command	-

## Display

Menu	PARAM RoPARA \ OVLOAD
------	-----------------------

## Value range

Value	Display	Description
-		
no default		

## 5.9.9 Actual Contouring Error

## General characteristics

EEPROM	no
Class	-
Unit	Steps

## EtherNet/IP

Data type	DINT
Access	Get
Instance	2577d / A11h
Web server	2577

## Service protocol

Read command	E99
Write command	-

## Display

Menu	PARAM RoPARA \ ConErr
------	-----------------------

## Value range

Value	Display	Description
-		
no default		

## 5.9.10 Gear Reduction

## General characteristics

EEPROM	yes
Class	-
Unit	-

## EtherNet/IP

Data type	INT
Access	Get
Instance	2571d / A0Bh
Web server	2571

## Service protocol

Read command	A4
Write command	-

## Display

Menu	PARAM RoPARA \ REduc
------	----------------------

## Value range

Value	Display	Description
-		
no default		

### 5.9.11 Encoder Resolution

General characteristics

EEPROM	yes
Class	-
Unit	Steps

EtherNet/IP

Data type	INT
Access	Get
Instance	2573d / A0Dh
Web server	2573

Service protocol

Read command	G034
Write command	-

Display

Menu	PARAM RoPARA \ EncRES
------	-----------------------

Value range

Value	Display	Description
-		
no default		

### 5.9.12 Serial Number

General characteristics

EEPROM	yes
Class	-
Unit	-

EtherNet/IP

Data type	DINT
Access	Get
Instance	2568d / A08h
Web server	2568

Service protocol

Read command	A5
Write command	-

Display

Menu	PARAM RoPARA \ SEr No
------	-----------------------

Value range

Value	Display	Description
-		
no default		

### 5.9.13 SW Motor Controller

General characteristics

EEPROM	yes
Class	-
Unit	-

EtherNet/IP

Data type	DINT
Access	Get
Instance	2570d / A0Ah
Web server	2570

Service protocol

Read command	A1
Write command	-

Display

Menu	PARAM RoPARA \ VErDrv
------	-----------------------

Value range

Value	Display	Description
-		
no default		

### 5.9.14 SW Ethernet Module

General characteristics

EEPROM	yes
Class	-
Unit	-

EtherNet/IP

Data type	DINT
Access	Get
Instance	-
Web server	-

## Service protocol

Read command	A2
Write command	-

## Display

Menu	PARAM RoPARA \ VErMod
------	-----------------------

## Value range

Value	Display	Description
-		
no default		

**5.9.15 Production Date**

## General characteristics

EEPROM	yes
Class	-
Unit	DDMMJJJJ

## EtherNet/IP

Data type	DINT
Access	Get
Instance	2569d / A09h
Web server	2569

## Service protocol

Read command	A6
Write command	-

## Display

Menu	PARAM RoPARA \ DtProd
------	-----------------------

## Value range

Value	Display	Description
-		
no default		

**5.9.16 Device ID**

## General characteristics

EEPROM	yes
Class	-
Unit	-

## EtherNet/IP

Data type	USINT
Access	Get
Instance	2574d / A0Eh
Web server	2574

## Service protocol

Read command	-
Write command	-

## Display

Menu	-
------	---

## Value range

Value	Display	Description
3		AG24

### 5.9.17 Generic Mapping Channel

Device information can be transmitted in the Generic Mapping Channel (see chapter [5.5.6](#)).

## General characteristics

EEPROM	no
Class	PD
Unit	-

## EtherNet/IP

Data type	DINT
Access	Get
Instance	260d / 104h
Web server	260

## Service protocol

Read command	-
Write command	-

## Display

Menu	-
------	---

## Value range

Value	Display	Description
-		
no default		



## 5.10 Error memory

### 5.10.1 Number of Errors

General characteristics

EEPROM	yes
Class	E
Unit	-

EtherNet/IP

Data type	USINT
Access	Get
Instance	2817d / B01h
Web server	2817

Service protocol

Read command	J00
Write command	-

Display

Menu	PARAM ErrBuF \ Err No
------	-----------------------

Value range

Value	Display	Description
-		
no default		

### 5.10.2 Error Number 1

General characteristics

EEPROM	yes
Class	E
Unit	-

EtherNet/IP

Data type	USINT
Access	Get
Instance	2818d / B02h
Web server	2818

Service protocol

Read command	J01
Write command	-

Display

Menu	PARAM ErrBuF \ Err 01
------	-----------------------

Value range

Value	Display	Description
-		
no default		

### 5.10.3 Error Number 2

General characteristics

EEPROM	yes
Class	E
Unit	-

EtherNet/IP

Data type	USINT
Access	Get
Instance	2819d / B03h
Web server	2819

Service protocol

Read command	J02
Write command	-

Display

Menu	PARAM ErrBuF \ Err 02
------	-----------------------

Value range

Value	Display	Description
-		
no default		

### 5.10.4 Error Number 3

General characteristics

EEPROM	yes
Class	E
Unit	-

## EtherNet/IP

Data type	USINT
Access	Get
Instance	2820d / B04h
Web server	2820

## Service protocol

Read command	J03
Write command	-

## Display

Menu	PARAM ErrBuF \ Err 03
------	-----------------------

## Value range

Value	Display	Description
-		
no default		

## 5.10.5 Error Number 4

## General characteristics

EEPROM	yes
Class	E
Unit	-

## EtherNet/IP

Data type	USINT
Access	Get
Instance	2821d / B05h
Web server	2821

## Service protocol

Read command	J04
Write command	-

## Display

Menu	PARAM ErrBuF \ Err 04
------	-----------------------

## Value range

Value	Display	Description
-		
no default		

### 5.10.6 Error Number 5

General characteristics

EEPROM	yes
Class	E
Unit	-

EtherNet/IP

Data type	USINT
Access	Get
Instance	2822d / B06h
Web server	2822

Service protocol

Read command	J05
Write command	-

Display

Menu	PARAM ErrBuF \ Err 05
------	-----------------------

Value range

Value	Display	Description
-		
no default		

### 5.10.7 Error Number 6

General characteristics

EEPROM	yes
Class	E
Unit	-

EtherNet/IP

Data type	USINT
Access	Get
Instance	2823d / B07h
Web server	2823

Service protocol

Read command	J06
Write command	-

Display

Menu	PARAM ErrBuF \ Err 06
------	-----------------------

Value range

Value	Display	Description
-		
no default		

### 5.10.8 Error Number 7

General characteristics

EEPROM	yes
Class	E
Unit	-

EtherNet/IP

Data type	USINT
Access	Get
Instance	2824d / B08h
Web server	2824

Service protocol

Read command	J07
Write command	-

Display

Menu	PARAM ErrBuF \ Err 07
------	-----------------------

Value range

Value	Display	Description
-		
no default		

### 5.10.9 Error Number 8

General characteristics

EEPROM	yes
Class	E
Unit	-

EtherNet/IP

Data type	USINT
Access	Get
Instance	2825d / B09h
Web server	2825

## Service protocol

Read command	J08
Write command	-

## Display

Menu	PARAM ErrBuF \ Err 08
------	-----------------------

## Value range

Value	Display	Description
-		
no default		

**5.10.10 Error Number 9**

## General characteristics

EEPROM	yes
Class	E
Unit	-

## EtherNet/IP

Data type	USINT
Access	Get
Instance	2826d / B0Ah
Web server	2826

## Service protocol

Read command	J09
Write command	-

## Display

Menu	PARAM ErrBuF \ Err 09
------	-----------------------

## Value range

Value	Display	Description
-		
no default		

**5.10.11 Error Number 10**

## General characteristics

EEPROM	yes
Class	E
Unit	-

## EtherNet/IP

Data type	USINT
Access	Get
Instance	2827d / B0Bh
Web server	2827

## Service protocol

Read command	J10
Write command	-

## Display

Menu	PARAM ErrBuF \ Err 10
------	-----------------------

## Value range

Value	Display	Description
-		
no default		

## 6 Service protocol

<b>NOTICE</b>	If there is process data exchange with a network master, writing of parameters and execution of commands via the service protocol are disabled. In this case, the drive replies with the error code "?03", no operating authorization.
---------------	--

### 6.1 General Information

The service protocol enables parameterization and control of the drive by ASCII commands via an ASCII terminal.

#### 6.1.1 Communication

#### 6.1.2 Settings

Available baud rates: 9.6 kBit/s / 19.2 kBit/s / 57.6 kBit/s (factory setting), 115.2 kBit/s  
Additional settings: no parity, 8 data bits, 1 stop bit, no handshake

#### 6.1.3 ASCII commands

An ASCII command consists of an ASCII character and additional arguments such as parameter address, mathematical sign and value.

Length and format of an ASCII command are defined unchangeably.

### 6.1.4 Responses

Except for a few cases, the actuator responds to ASCII commands with a terminating string (ASCII-character ">" + Carriage Return "<CR>"). The responses to read commands contain return values in addition. Length and format of the response are defined unchangeably.

## 6.2 Commands

### 6.2.1 Start travel job

Command	Description	Chapter
M	Positioning mode: - start of positioning process to programmed set point Speed mode: - start of speed mode	<a href="#">6.6</a>

### 6.2.2 Start of inching mode1

Command	Description	Chapter
Y	only in positioning mode	<a href="#">6.6</a>

### 6.2.3 Start inching mode 2 positive travel direction

Command	Description	Chapter
, (2Ch)	Drive travels in positive direction as long as the "," ASCII character is permanently sent (only in positioning mode).	<a href="#">6.6</a>

### 6.2.4 Start inching mode 2 negative travel direction

Command	Description	Chapter
. (2E)	Drive travels in negative direction as long as the "." ASCII character is permanently sent (only in positioning mode).	<a href="#">6.6</a>

### 6.2.5 Cancel current travel job in positioning mode

Command	Description	Chapter
I (49)	Motor remains in control state	<a href="#">6.6</a>



**6.2.6 Motor stop fast**

<b>NOTICE</b>	If a contouring error is pending at the time of the "N" command, the motor will be enabled.
---------------	---

Command	Description	Chapter
N	Motor decelerates with maximum delay. Motor remains in control state!	<a href="#">6.6</a>

**6.2.7 Motor stop**

<b>NOTICE</b>	If a contouring error is pending at the time of the "O" command, the motor will be enabled.
---------------	---

Command	Description	Chapter
O	Motor decelerates with programmed delay. Motor remains in control state!	<a href="#">6.6</a>

**6.2.8 Activate motor**

Command	Description	Chapter
P	Motor is activated.	<a href="#">6.6</a>

**6.2.9 Factory setting: all parameters**

Command	Description	Chapter
S11100	Reset all parameters to factory settings	<a href="#">6.6</a>

**6.2.10 Factory setting: Standard parameter**

Command	Description	Chapter
S11101	Reset only standard parameters to factory settings	<a href="#">6.6</a>

**6.2.11 Factory setting: Controller parameter**

Command	Description	Chapter
S11102	Reset only controller parameters to factory settings	<a href="#">6.6</a>

**6.2.12 Factory setting: Visualization parameters**

Command	Description	Chapter
S11003	Reset only visualization parameters to factory setting	<a href="#">6.6</a>

**6.2.13 Factory setting: Network parameters**

Command	Description	Chapter
S11004	Reset only network parameters to factory setting	<a href="#">6.6</a>

**6.2.14 Acknowledge error**

Command	Description	Chapter
S11103	Acknowledge active error	<a href="#">6.6</a>

**6.2.15 Calibrate**

Command	Description	Chapter
S11104	Calibrate actuator	<a href="#">6.6</a>

**6.2.16 Delete error memory**

Command	Description	Chapter
S11105	Deleting of the error memory	<a href="#">6.6</a>

**6.2.17 Software reset**

Command	Description	Chapter
K	Execute software reset	<a href="#">6.6</a>

### 6.3 Flow charts

#### 6.3.1 Flow chart: Operating mode: Positioning mode

The flow chart below shows the control of positioning in the positioning mode via service protocol (see chapter 6).

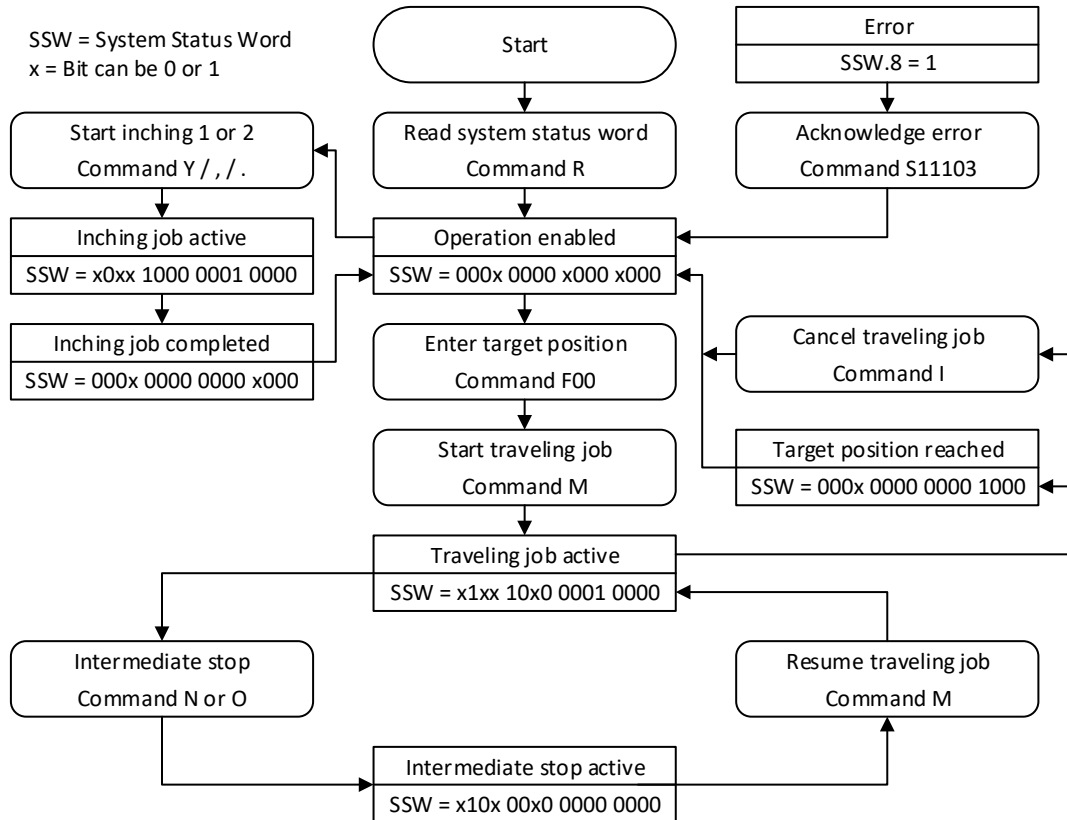

Fig. 18: Flowchart positioning mode service protocol

### 6.3.2 Flow chart: Operating mode: Speed mode

The flow chart below illustrates the control in the rotational speed mode via service protocol (see chapter 6).

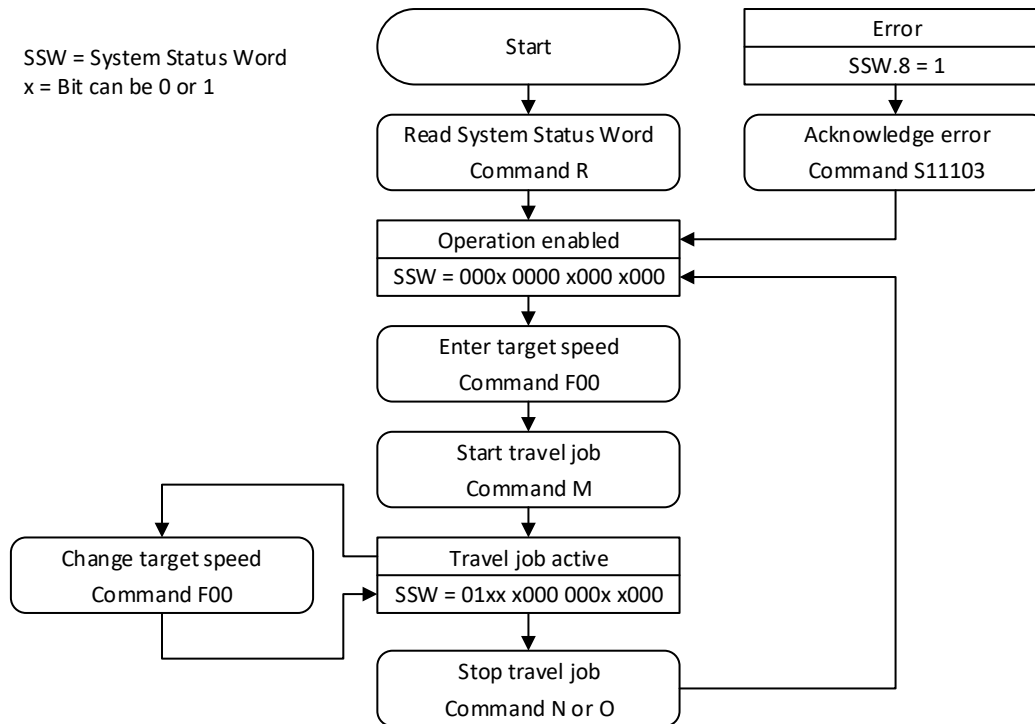

Fig. 19: Flow chart speed mode service protocol

### 6.4 Error number encoding

Faulty inputs are acknowledged with an error message. An error message is always prefixed by a question mark, followed by a two-digit error code. The error message ends with a carriage return "<CR>".

Code	Description
?01	Input of illegal parameter number
?02	Illegal value range
?03	No operating authorization (active process data exchange with network master)
?04	Input disabled due to operating state
?05	Limit switch 1 active
?06	Limit switch 2 active
?07	Actual or target value > upper software limit
?08	Actual or target value < lower software limit
?09	Set point entered exceeds limiting value
?10	Error
?11	Active EEPROM write access
?12	Actual or target value < lower area limit
?13	Actual or target value > upper area limit
?14	Operating voltage of control missing

## 6.5 Examples

### 6.5.1 Write and read set point +500

Write command: F0+0000500 (10 characters)

Reply: ><CR> (2 characters)

Read command: E00 (2 characters)

Reply: +0000500><CR> (10 characters)

### 6.5.2 Start travel job

Command: M (1 character)

Reply: ><CR> (2 characters)

## 6.6 ASCII command structure

Command	Length	Access	Reply	CR	Length	Description
Ay	2	read	xxxxxxx>	x	10	Device information (constants) y = address xxxxxxx = string
Byyy	4	read	±xxxxxxx>	x	10	Device information (actual values) yyy = address ±xxxxxxx = decimal value
Eyy	3	read	±xxxxxxx>	x	10	Read parameter (3-byte) yy = address ±xxxxxxx = decimal value
Fyy±xxxxxxx	11	write	>	x	2	Write parameter (3-byte) yy = address ±xxxxxxx = decimal value
Gyyy	4	read	xxxxx>	x	7	Read parameter (2-byte) yyy = address xxxxx = decimal value
Hyyyxxxx	9	write	>	x	2	Write parameter (2-byte) yyy = address xxxxx = decimal value
I	1	write	>	x	2	Cancel current travel job in positioning mode
Jyy	3	read	0xhh>	x	6	Error memory yy = address hh = hexadecimal value
K	1	write	>	x	2	Software reset
Lx	2	write	>	x	2	Type of positioning x = decimal value
M	1	write	>	x	2	Start travel job

Command	Length	Access	Reply	CR	Length	Description
N	1	write	>	x	2	Motor stop fast
O	1	write	>	x	2	Motor stop
P	1	write	>	x	2	Activate motor
Q	1	read	0xhh>	x	6	Flag register hh = hexadecimal value
R	1	read	0xhll>	x	8	System status word hh = hexadecimal value High byte ll = hexadecimal value Low byte
Sxxxxx	6	write	>	x	2	System command xxxxx = code
Tx	2	write	>	x	2	Sense of rotation x = decimal value
Uxxxx	5	read	bbbb		4	Read parameter (4-byte) bbbb = binary value in the Big-Endian format
V	1	read	±xxxx>	x	7	Actual rotational speed ±xxxx = decimal value with arithmetical sign
W	1	read	bbbb		4	Position value in binary format bbbb = binary value in the Big-Endian format
Xy	2	write	>	x	2	Operating mode y = decimal value
Y	1	write	>	x	2	Start of inching mode 1
Z	1	read	±xxxxxxxx>	x	10	Position value ±xxxxxxxx decimal value
, (2Ch)	1	write			0	Start inching mode 2 positive travel direction
. (2Eh)	1	write			0	Start inching mode 2 negative travel direction

## 6.7 Commissioning aids

The ProTool DL programming software serves easy commissioning and analysis via the service protocol. The RS232 interface is connected via the AIF01 programming tool and the M12/RS232 cable adapter from the SIKO accessory program.

## 7 Ethernet Functions

### 7.1 Web server

**NOTICE**

No parameters that are components of process data can be changed. Drive control via web server is not possible. Only an authorized network master can access the process data via the network.

The inbuilt web server enables configuration and parameterization without network master via the Ethernet interface.

The web server can be accessed via the set IP address.

Settings for IP and Ethernet can be made via the Configuration menu.

The screenshot shows the 'Configuration' menu in the SIKO web server interface. The 'IP Configuration' section includes fields for DHCP (Disabled), IP Address (10.20.3.50), Subnet Mask (255.255.255.0), Gateway Address (0.0.0.0), Host Name, Domain name, DNS Server #1 (0.0.0.0), and DNS Server #2 (0.0.0.0). The 'Ethernet Configuration' section shows Port config set to Auto. A red box highlights the 'Configuration' menu item in the left sidebar.

Fig. 20: Web server/Configuration

Below, the parameter menu is shown. The process data is within the red mark.

The screenshot shows the 'Parameters' menu in the SIKO web server interface. It displays a table of parameters with columns for #, Name, and Value. A red box highlights the 'Configuration' menu item in the left sidebar and the 'Generic Mapping Channel' parameter (ID 260) in the table.

#	Name	Value	
1	Digital Outputs Control	0	Set
2	Control Word	0	Set
3	Target Value	0	Set
257	Digital Inputs State	0	
258	Status Word	33	
259	Actual Value	0	
260	Generic Mapping Channel	0	
545	Service Interface Baud Rate	1	Set
546	Generic Mapping Parameter	0	Set
577	Peak Current Limit	10000	Set

Fig. 21: Web server/Parameters

The web server can be activated or deactivated via the Configuration parameter (see chapter 5.5.7).

The web server is activated in the factory settings.

## 7.2 FTP-Server

The integrated FTP server enables access to the file system of the Ethernet module via a FTP client. Thus, the firmware of the Ethernet module can be updated via the network.

The following port numbers are used for FTP communication:

- TCP, Port 20 (FTP data transmission)
- TCP, Port 21 (FTP control)

The FTP server can be activated ore deactivated via the Configuration parameter (see chapter [5.5.7](#)).

The FTP server is activated in the factory settings.

## 7.3 Secure Host IP Configuration Protocol (Secure HICP)

The drive supports the Secure HICP protocol, which is used by the Anybus IPconfig application for changing the setting of IP address, subnet mask and DHCP via the network.

The protocol can be activated ore deactivated via the Configuration parameter (see chapter [5.5.7](#)).

The protocol is activated in the factory settings.

The HICP protocol communicates via UDP port 3250.



## 8 Block diagram

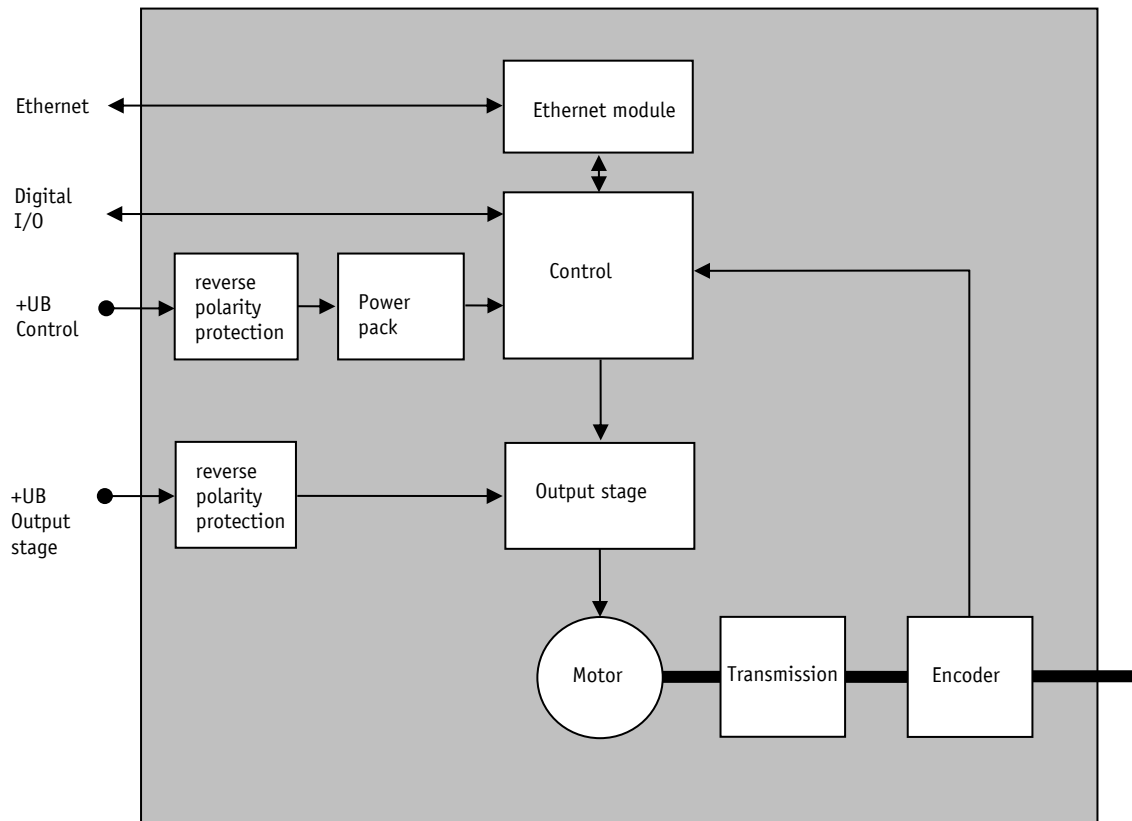

Fig. 22: Block diagram



**SIKO GmbH**

Weihermattenweg 2  
79256 Buchenbach

**Phone**

+ 49 7661 394-0

**Fax**

+ 49 7661 394-388

**E-Mail**

[info@siko-global.com](mailto:info@siko-global.com)

**Internet**

[www.siko-global.com](http://www.siko-global.com)

**Service**

[support@siko-global.com](mailto:support@siko-global.com)