

AP20

Absolute Position Indicator
with ETHERNET **POWERLINK** interface

User manual



Table of contents

1	General Information	7
1.1	Documentation	7
1.1.1	History	7
1.2	Definitions	7
1.3	Intended use	7
1.4	Switching on the operating voltage.....	8
2	Display and control keys	8
2.1	General	8
2.2	LCD display.....	9
2.2.1	Extended display range	9
2.3	LED display.....	9
2.3.1	Positioning status	9
2.3.1.1	Device status LED1, LED2.....	10
2.3.2	POWERLINK module status.....	10
2.3.2.1	BS Status LED3.....	10
2.3.2.2	Link/Activity LED4, LED5	10
2.3.2.3	BE Error LED6.....	11
2.4	Control keys.....	11
3	Functional Description	11
3.1	Operating modes	11
3.1.1	Position-bound operating modes	11
3.1.1.1	Target window	12
3.1.1.2	Directional arrows.....	13
3.1.1.3	LED display.....	13
3.1.1.4	Loop positioning	14
3.1.2	Control word: Position-dependent operating modes	14
3.1.3	Status word: Position-dependent operating modes.....	15
3.1.4	Alpha-numeric display operating mode.....	16
3.1.5	Control word: Alpha-numeric display operating mode	17
3.1.6	Status word: Alpha-numeric display operating mode.....	18
3.2	Battery buffering.....	18
3.3	Parameterization of the position indicator	19
3.3.1	Manual parameterization	19
3.3.1.1	Starting parameterization	19
3.3.1.2	Value input.....	19
3.3.1.3	Value selection.....	19
3.3.1.4	Overview of the operating menu	20
3.3.1.5	"Changeable parameters" menu	21
3.3.1.6	Quick Setup	21
3.3.1.7	POWERLINK.....	21
3.3.1.8	Positioning.....	22

3.3.1.9	Visualization.....	22
3.3.1.10	LED function.....	22
3.3.1.11	Device options.....	23
3.3.2	Parameterization via interface.....	23
3.4	Calibration.....	23
3.5	Additional functions.....	24
3.5.1	Device data.....	24
3.5.2	Diagnosis.....	24
3.5.2.1	Reading the error memories.....	24
3.5.2.2	Presentation.....	25
3.5.3	Restore factory settings.....	25
3.6	Warnings / Errors.....	25
3.6.1	Warnings.....	25
3.6.2	Errors.....	26
4	Parameters.....	27
4.1	Parameter overview.....	27
4.2	Positioning.....	29
4.2.1	Resolution.....	29
4.2.2	Decimal Places.....	30
4.2.3	Counting Direction.....	31
4.2.4	Calibration Value.....	31
4.2.5	Offset Application.....	32
4.2.6	Target Window.....	32
4.2.7	Target Window Extended.....	33
4.2.8	Loop Type.....	33
4.2.9	Loop Length.....	34
4.2.10	Control Word.....	35
4.2.11	Status Word.....	35
4.2.12	Target Value.....	36
4.2.13	Actual Value.....	36
4.2.14	Speed Value.....	36
4.3	Visualization.....	37
4.3.1	Display Orientation.....	37
4.3.2	Direction Indicators.....	38
4.3.3	Displayed Value 2nd Line.....	38
4.3.4	Target Window Extended Visualization.....	39
4.3.5	Active LCD Backlight White.....	39
4.3.6	Active LCD Backlight Red.....	40
4.3.7	Active LCD Backlight Flashing.....	41
4.4	LEDs.....	41
4.4.1	LED1 Green Mode.....	41
4.4.2	LED1 Red Mode.....	42
4.4.3	LED2 Green Mode.....	42

4.4.4	LED2 Red Mode	43
4.4.5	Active LED Flashing	44
4.5	Options	44
4.5.1	Operating Mode	44
4.5.2	Display Data	45
4.5.3	Display String Mode.....	45
4.5.4	Display String1	46
4.5.5	Display String2	47
4.5.6	Difference Value.....	47
4.5.7	Difference Value Mode	48
4.5.8	Display Factor.....	48
4.5.9	Display Divisor.....	50
4.5.10	Display Divisor Mode	51
4.5.11	Key Enable Time.....	51
4.5.12	Key Configuration	52
4.5.13	Key Calibration	52
4.5.14	Key Incremental.....	53
4.5.15	Key Acknowledgment Mode.....	54
4.5.16	PIN Change	54
4.5.17	CODE Input	55
4.5.18	Generic Mapping Parameter	55
4.5.19	System Configuration.....	56
4.5.20	Module Parameters	57
4.5.21	System Command	57
4.6	Device information	58
4.6.1	Battery Voltage.....	58
4.6.2	Operation Voltage	59
4.6.3	Temperature	59
4.6.4	Actual Calibration Value	60
4.6.5	Software Version Application	60
4.6.6	Software Version Ethernet Module	61
4.6.7	Serial Number	61
4.6.8	Production Date.....	62
4.6.9	MAC Address.....	62
4.6.10	Device Identification	63
4.6.11	Generic Mapping Channel	63
4.7	Error Memory	64
4.7.1	Error Count	64
4.7.2	Error Number 1	64
4.7.3	Error Number 2	65
4.7.4	Error Number 3	65
4.7.5	Error Number 4	66
4.7.6	Error Number 5	66
4.7.7	Error Number 6	67

4.7.8	Error Number 7	67
4.7.9	Error Number 8	68
4.7.10	Error Number 9	68
4.7.11	Error Number 10.....	69
4.7.12	Error Status.....	69
5	Ethernet POWERLINK®.....	70
5.1	Description.....	70
5.1.1	IP Configuration	70
5.1.2	Cyclic data exchange	70
5.1.3	Acyclic data exchange	71
5.1.4	Operating modes and synchronization.....	71
5.2	Directory of objects	71
5.2.1	Parameter description of standard objects	71
5.2.1.1	1000h: NMT_DeviceType_U32	71
5.2.1.2	1001h: ERR_ErrorRegister_U8	71
5.2.1.3	1006h: NMT_CycleLen_U32	71
5.2.1.4	1008h: NMT_ManufactDevName_VS	72
5.2.1.5	1009h: NMT_ManufactHwVers_VS	72
5.2.1.6	100Ah: NMT_ManufactSwVers_VS	72
5.2.1.7	1018h: Identity Object.....	72
5.2.1.8	1020h: CFM_VerifyConfiguration_REC.....	73
5.2.1.9	1021h: CFM_StoreDevDescrFile_DOM.....	74
5.2.1.10	1022h: CFM_StoreDevDescrFormat_U16.....	74
5.2.1.11	1030h: NMT_InterfaceGroup_00h_REC	75
5.2.1.12	1300h: SDO_SequLayerTimeout_U32.....	77
5.2.1.13	1400h: PDO_RxCommParam_00h_REC	77
5.2.1.14	1600h: PDO_RxMappParam_00h_AU64.....	77
5.2.1.15	1800h: PDO_TxCommParam_00h_REC.....	78
5.2.1.16	1A00h: PDO_TxMappParam_00h_AU64.....	79
5.2.1.17	1C0Bh: DLL_CNLossSoC_REC	80
5.2.1.18	1C0Fh: DLL_CNCRCErrror_REC	81
5.2.1.19	1C14h: DLL_CNLossOfSocTolerance_U32	82
5.2.1.20	1F50h: PDL_DownloadProgData_ADOM.....	82
5.2.1.21	1F51h: PDL_ProgCtrl_AU8	82
5.2.1.22	1F52h: PDL_LocVerApplSw_REC.....	83
5.2.1.23	1F81h: NMT_NodeAssignment_AU32.....	83
5.2.1.24	1F82h: NMT_FeatureFlags_U32	84
5.2.1.25	1F83h: NMT_EPLVersion_U8	84
5.2.1.26	1F8Ch: NMT_CurrNMTState_U8	84
5.2.1.27	1F8Dh: NMT_PresPayloadLimitList_AU16	85
5.2.1.28	1F93h: NMT_EPLNodeID_REC	85
5.2.1.29	1F98h: NMT_CycleTiming_REC.....	86
5.2.1.30	1F99h: NMT_CNBasicEthernetTimeout_U32	87

5.2.1.31	1F9Bh: NMT_MultiplCycleAssign_AU8.....	88
5.2.1.32	1F9Eh: NMT_ResetCmd_U8	88
5.2.2	Parameter description of manufacturer-specific objects	88
5.3	Commissioning aids	88
6	Block diagram	89

1 General Information

1.1 Documentation

The following documents are associated with this document:

- The data sheet describes the technical data, the dimensions, the pin assignment, the accessories and the order key.
- The installation instructions describe the mechanical and electrical installation with all safety-relevant conditions and the associated technical specifications.
- The User manual for actuator commissioning and integration into a fieldbus system.

You can also download these documents at <http://www.siko-global.com/p/ap20>.

Additional information and guidance regarding this device can also be found there.

1.1.1 History

Mod. status	Date	Description
247/22	December 5, 2022	from firmware V2.00 Chapter 1.1.1 History new added Chapter 3.6.2 Errors Set added Chapter 4.2.1 Resolution Value range changed Chapter 4.5.1 Operating Mode Set added Chapter 4.5.15 Key Acknowledgment Mode Value range changed Chapter 4.5.21 System Command Parameter selection value 3 changed
198/23	November 20, 2023	from firmware V2.01 Chapter 4.5.8 Display Factor Text extended

1.2 Definitions

If not explicitly stated otherwise, decimal values are given as figures without an extension (e. g. 1234), binary values are marked after the figure with a b (e. g. 1011b), hexadecimal values with an h (e. g. 280h). Individual bits of larger logic units are named with their value after a dot (e. g., CW.9; control word bit 9).

1.3 Intended use

For the further functional description, normal operation of the system with unchanged factory setting is assumed unless otherwise described.

The present device is an absolute position indicator with integrated Industrial Ethernet interface and a hollow shaft for direct shaft mounting. Indicators, control buttons and interface are only active with external power supply. The sensor of measurement encoder works magnetically incrementally. Without an external power supply, encoder changes are recorded with battery support. The status of the replaceable battery is monitored. A volatile target value can be displayed below the actual value via the backlit two-line LC display. A direction display (indicator) is displayed if there is a deviation between the actual value and the target window (target value including Target Window parameter). The indicator direction indicates in which direction the sensor must be moved to reach the target window. In addition, the position status of two two-color LEDs (green and red) is displayed. Device malfunctions or inadmissible operating states are recorded in an error memory.

The buttons can be used to select various functions and to adapt the device parameters stored in a non-volatile memory to the application. The actual value can be queried via the interface, the target value can be changed and all device parameters can be adjusted.

1.4 Switching on the operating voltage

The AP20 will be initialized after switching on the supply voltage. A system and display test is executed during initialization, the LEDs are lighted consecutively and the parameters are loaded from the non-volatile memory into the RAM of the controller. At first use, the default values are used during initialization. After the return of the external power supply or software reset (warm start), the AP20 works with the last saved parameters. Unless a fault has been detected, the AP20 starts normal operation.

2 Display and control keys

2.1 General

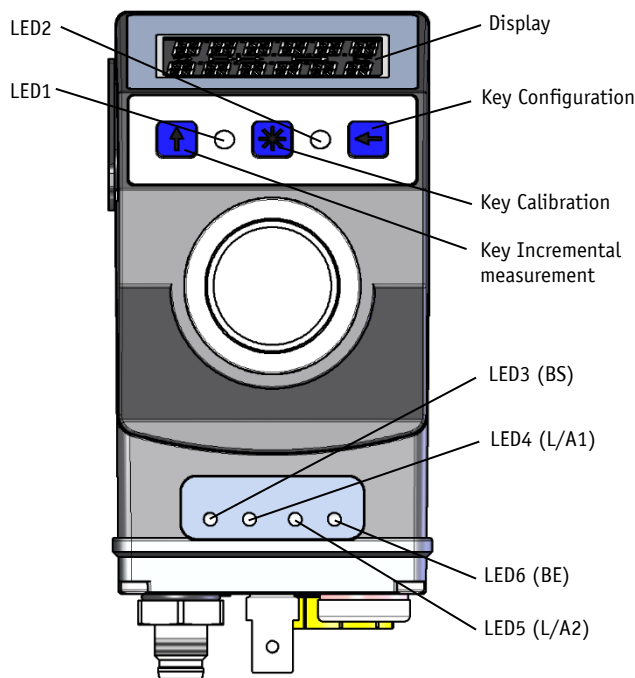



Fig. 1: Display and control elements

2.2 LCD display

NOTICE	The display range is limited to -199999 ... 999999. Values outside this range are displayed with "FULL".
---------------	--

The actual value is displayed in the first line and "----" in the second line. The target value can be declared valid by means of CW.9 = 1 and displayed in the second line. If necessary, a direction indicator (arrow) is also displayed.

The battery status is indicated by the battery symbol . If battery voltage Target value acknowledgment mode critical value, the battery symbol on the display will flash. If the value falls below a minimum value or if the battery is missing, the symbol lights permanently.

With incremental measurement function activated, the incremental measurement symbol  is shown.

This is signaled in red letters in the event of a fault.

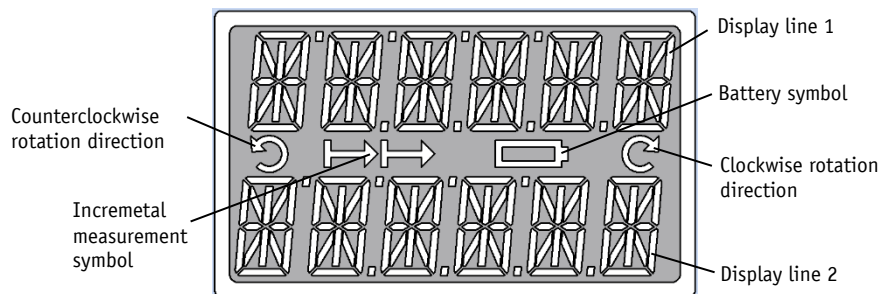

Fig. 2: Two-line 14 segment LCD display

2.2.1 Extended display range

Values up to -199999 can be displayed by means of the control word. If the relevant bit has been set and the value to be displayed is between -199999 and -999999, then the negative sign and the digit of the highest order will flash alternately. If the value range drops below -999999, "FULL" will be displayed.

2.3 LED display

2.3.1 Positioning status

NOTICE	A test sequence is executed on these LEDs during initialization.
---------------	--

When the target value is displayed, the LED1, LED2 inform about a deviation between the actual value and the target window. The function of positioning status LEDs can be configured.

2.3.1.1 Device status LED1, LED2

LED states valid at factory setting.

LED state	Description
off	No operating voltage or no valid target value.
green	Valid target value, actual value in the target window.
red	Valid target value, actual value outside target window.

In order for LED1 or LED2 to be controlled via the control word, this function of the LEDs must be activated by means of parameters.

2.3.2 POWERLINK module status

NOTICE	A test sequence is executed on these LEDs during initialization.
---------------	--

LED3, LED4, LED5, and LED6 inform about the status of the Ethernet module. The functions of the Ethernet module LEDs are permanently defined and cannot be changed.

2.3.2.1 BS Status LED3

LED state	Description
off	no error or no operating voltage
green, quickly flashing (50 ms on / 50 ms off)	no POWERLINK traffic detected
green, flashing 1x	NMT_CS_PRE_OPERATIONAL_1 only asynchronous data
green, flashing 2x	NMT_CS_PRE_OPERATIONAL_2 asynchronous and synchronous data no PDO data
green, flashing 2x	NMT_CS_READY_TO_OPERATE ready to operate
green	NMT_CS_OPERATIONAL in operation PDO data is sent and received.
green, slowly flashing (200 ms on / 200 ms off)	module stopped (e. g. for controlled shutdown) no PDO data
red	a fatal event has occurred if the ERROR LED is also red

2.3.2.2 Link/Activity LED4, LED5

LED state	Description
off	no connection, no activity
green	connection (100 Mbit/s) established
green, flickers	activity (100 Mbit/s)

2.3.2.3 BE Error LED6

LED state	Description
off	no error or no operating voltage
red	A non-fatal error has occurred if the STATUS LED is not red. A fatal error has occurred if the STATUS LED is red.

2.4 Control keys

Pressing  the Incremental button switches the increment function or a relative measurement on or off.

Pressing  the Calibration button starts the calibration and acknowledges an existing fault. In the "Alphanumeric display" operating mode, the receipt of a set point is acknowledged by this action.

Pressing  the Configuration button starts the parameterization.

See also [Fig. 1](#).

3 Functional Description

3.1 Operating modes

The following position-dependent operating modes are differentiated: **Absolute position**, **Differential value**, **Modulo** and the position-independent operating mode **Alpha-numeric display**.

3.1.1 Position-bound operating modes

The measured absolute position value is displayed, calculated depending on the Resolution, Display Divisor, Decimal Places and Display Factor parameters. Via the interface, the actual value can be provided to an upstream control and a target value specified.

Absolute position:

Linear absolute actual values are displayed

Line 1: actual value; CW.9 = 0, 2. Line: "----" or CW.9 = 1, Line 2: target value

Calculation of the actual value:

$$\text{Actual value} = \frac{\text{Position value} \times \text{calculation factor}}{\text{Display divisor}} \quad \text{Position value} = \text{internally measured value} + \text{calibration value} + \text{offset value}$$

Differential value display:

A linear absolute actual value and a differential value are displayed. The differential value is calculated as follows: Differential value = actual value – target value.

Line 1: actual value; CW.9 = 0, 2. Line: "----" or CW.9 = 1, Line 2: Differential value

The calculation of the differential value can be set via the parameter Difference Value Mode (see chapter 4.5.7).

Modulo display:

Actual values ranging from 0° to 360° are displayed.

Line 1: actual value; CW.9 = 0, 2. Line: "----" or CW.9 = 1, Line 2: target value

Using the parameter Decimal Places (see chapter 4.2.2) the resolution and the modulo point of the displayed values are set.

Decimal places	Display resolution	Value range
0	1°	0°...360°
1	1/10°	0.0°...360.0°
2	1/100°	0.00°...360.00°
3	1/1000°	0.000°...360.000°
4	1/10000°	0.0000°...360.0000°

Table 1: Modulo display

3.1.1.1 Target window

A target window is formed to be able to define a tolerance range.

Target window = Target Value ± Target Window

Example Position monitoring:

Target Window = 5

Target Value = 100

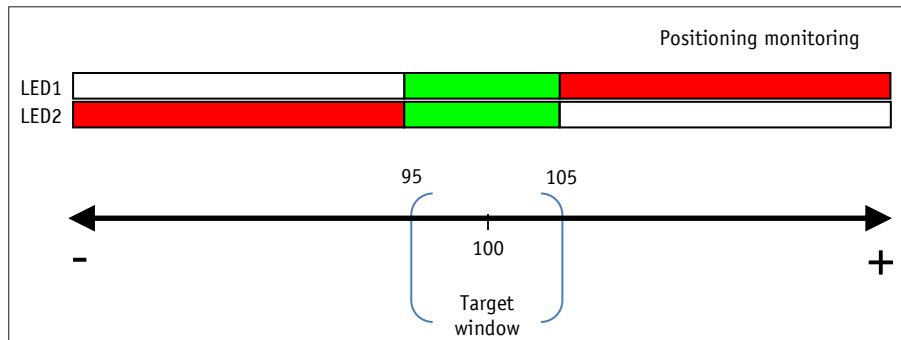

Fig. 3: Positioning monitoring with Target Window

An additional, extended target window and an associated visualization of the extended target window can be additionally parameterized (see chapter 4.2.7 or 4.3.4).

Example of position monitoring with additionally activated Target Window Extended parameter:

Target Window Extended = 15

Target Window Extended Visible = 1

Target Value = 100

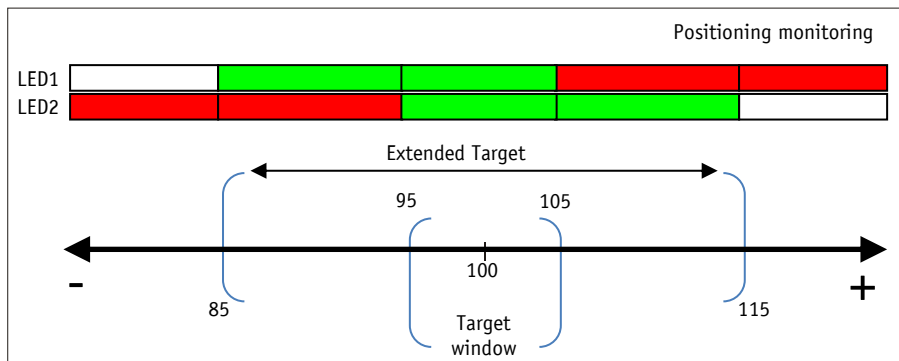

Fig. 4: Positioning monitoring with Target Window Extended

3.1.1.2 Directional arrows

To assist in positioning, direction arrows are displayed in the display as long as the current actual value is outside the valid target window. The arrow direction indicates in which direction the shaft must be moved to reach the target window.

3.1.1.3 LED display

With factory setting, the LED glows green as long as the actual value is within the programmed window. When leaving target window, the LED glows red. The shaft must be rotated in the direction of the glowing LED in order to arrive at the target value. The red glowing LED1 (left): counter-clockwise (ccw) rotation required. Red glowing LED2 (right): clockwise (cw) rotation required.

With factory settings, the LED display (see Fig. 1) has the following meaning:

Operating state	LED	Meaning
There is no valid target value or no operating voltage.	Both LEDs inactive	No position monitoring active.
There is a valid target value.	Both LEDs green	The actual value is within the programmed target window.
	LED1 red	The actual value is outside the programmed target window. The axis must be rotated counterclockwise to reach the target window.
	LED2 red	The actual value is outside the programmed target window. The axis must be rotated clockwise to reach the target window.

Table 2: LED display

3.1.1.4 Loop positioning

NOTICE	Target window is also applied to the loop length.
---------------	---

NOTICE	The behavior of the clearance compensation is independent of the set counting direction of the display. The loop type must be changed to change the clearance compensation.
---------------	---

If the position indicator is operated on a spindle or an additional gear, the spindle or external gear backlash can be compensated by means of loop positioning. Therefore, movement towards the target value is always in the same direction. This direction of approach can be defined.

Example:

The direction, in which each setpoint position is to be moved to, is positive.

- Case1 ⇒ the new position is greater than actual value:
Die Sollposition wird direkt im Uhrzeigersinn (CW) angefahren.
- **Case 2** ⇒ the new position is smaller than actual value:
The directional arrows of the position indicator indicate that the loop length is to be moved counterclockwise (CCW) beyond the target position. Then the target value is approached clockwise.

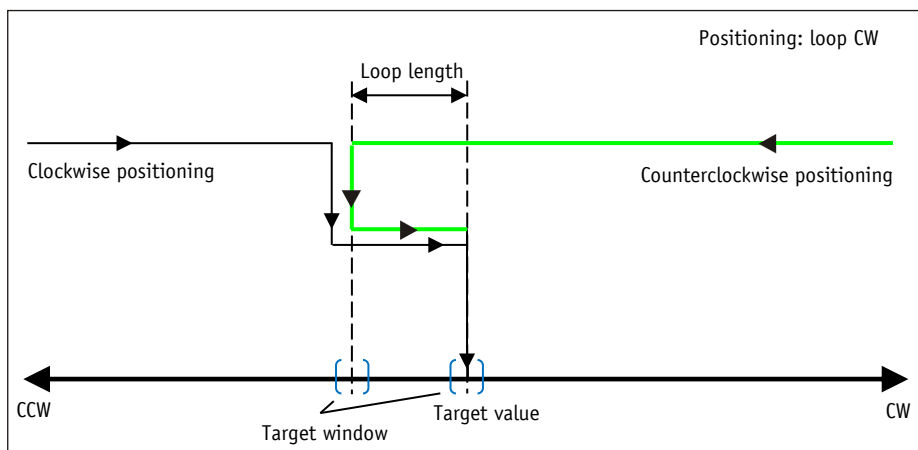

Fig. 5: Positioning Loop CW

3.1.2 Control word: Position-dependent operating modes

The control word consists of 16 bits and differs in function depending on the operating mode.

Control word															
15	14	13	12	11	10	9	8	7	6	5	4	3	2	1	0
MSB								LSB							
High Byte								Low Byte							

The designation of the individual bits of the control word as well as their meaning:

Bit	Meaning	Value = 0	Value = 1
0	Calibration execute	-	Trigger calibration (edge-controlled, positive)

Bit	Meaning		Value = 0	Value = 1
1	reserved		ever 0	-
2	reserved		ever 0	-
3	Display range		Normal display area	Extended display area
4	reserved		ever 0	-
5	Error acknowledge		-	Acknowledge error
6	reserved		ever 0	-
7	reserved		ever 0	-
8	reserved		ever 0	-
9	Target value activation		-	Activate target value
10	reserved		ever 0	-
11	LED1 green	Release via LED parameters required	Deactivate LED	Activate LED
12	LED1 red		Deactivate LED	Activate LED
13	LED2 green		Deactivate LED	Activate LED
14	LED2 red		Deactivate LED	Activate LED
15	LED blinking		Deactivate LED	Activate LED

Table 3: Control word operating mode Abs, Diff, Modulo

3.1.3 Status word: Position-dependent operating modes

NOTICE	The response to a target write command contains a status word that has not yet been updated.
---------------	--

The Status Word shows the current status of the AP20. It is composed of eight bits.

Status word																	
15	14	13	12	11	10	9	8	7	6	5	4	3	2	1	0		
MSB								Low Byte								LSB	

The designation of the individual bits of the control word as well as their meaning:

Bit	Meaning	Value= 0	Value= 1
0	Direction indication CW	Counterclockwise target value	Clockwise target value
1	Direction indication CCW	Clockwise target value	Counterclockwise target value
2	Calibration executed	No calibration is currently being carried out	A calibration is currently being carried out
3	Target window extended reached	Extended target window is not reached	Extended target window is reached
4	reserved	ever 0	-
5	Target window reached	Target window is not reached	Target window is reached
6	Deviation	Deviation Actual value \leq target value	Deviation Actual value $>$ target value
7	General error	No error	There is an error





Bit	Meaning	Value= 0	Value= 1
8	reserved	ever 0	-
9	Actual value = incremental measurement	Increment measurement is deactivated	Increment measurement is activated
10	Target value activation	Target value is not activated	Target value is activated
11	Battery state	Battery Charging state is OK	Battery Charging state is critical
12	Sensor error	There is no sensor error	There is a sensor error
13	Key Configuration 	Button is not pressed	Button is pressed
14	Key Calibration 	Button is not pressed	Button is pressed
15	Key Incremental 	Button is not pressed	Button is pressed

Table 4: Status word operating mode Abs, Diff, Modulo

3.1.4 Alpha-numeric display operating mode

Two 6-digit target values can be displayed in this operating mode. With factory settings, the target values are acknowledged by pressing the  key (see chapter 2.4 and parameter 4.5.15).

Alpha-numeric display:

Both lines are freely writable. The content of the display line can be transmitted via the Display Data parameter, and the content of the display line can be transmitted via the Target Value parameter. In this case, the bit for data identification must be set correctly in the respective control word. The data identifier is used to distinguish whether the data is interpreted and displayed as a number or as an alphanumeric character (ASCII) (see chapter 4.2.10, 4.2.12 and 4.5.2).

Alternatively, you can write directly in each display line using the Display String parameter in connection with the respective Display String1 or Display String2 (see chapter 4.5.2, 4.5.4 and 4.5.5)

LCD display:

If there is no valid target value, the 1st display line is displayed blank. "----" appears in the 2nd display line.

A valid target value is displayed flashing until its receipt is acknowledged. If neither target value has been acknowledged, both values are acknowledged jointly by pressing the  key.

LED display:

Status LED1 and LED2:

With factory settings, the LED display (LED1, LED2) works according to the following table.

Operating state	State	Meaning
There is no valid target value.	Both LEDs off	

Operating state	State	Meaning
There is a valid target value.	LED1 red	Display data not acknowledged
	LED1 green	Display data acknowledged
	LED2 red	Target value not acknowledged
	LED2 green	Target value acknowledged

Table 5: Status LED display in the alpha-numeric display operating mode

3.1.5 Control word: Alpha-numeric display operating mode

In the control word, the relevant type (number or character string) and the validity of the target value is transmitted to the display. As an additional option, the target value can be acknowledged via the control word.

The control word is composed of 16 bits.

Control word																
15	14	13	12	11	10	9	8	7	6	5	4	3	2	1	0	
MSB								Low Byte								LSB
High Byte																

The designation of the individual bits of the control word as well as their meaning:

Bit	Meaning	Value = 0	Value = 1	
0	reserved	ever 0	-	
1	reserved	ever 0	-	
2	Display data activation (display line 1)	-	Activate Display data	
3	Display range	standard	extended	
4	reserved	ever 0	-	
5	Error acknowledge	-	Acknowledge error	
6	Target value acknowledgment mode (display line 2)	Manually acknowledge target value	Acknowledge target value	
7	Target value data type (display line 2)	Interpret target value as a number	Interpret target value as ASCII character	
8	Display data data type (display line 1)	Interpret display data as a number	Interpret display data as ASCII character	
9	Target value activation (display line 2)	-	Activate target value	
10	Display data acknowledgment mode	Manually acknowledge display data	Acknowledge display data	
11	LED1 green	Function controlled via parameters LED1, LED2	Deactivate LED	Activate LED
12	LED1 red		Deactivate LED	Activate LED
13	LED2 green		Deactivate LED	Activate LED
14	LED2 red		Deactivate LED	Activate LED
15	LED blinking		Deactivate LED	Activate LED

Table 6: Control word alpha-numeric display operating mode

3.1.6 Status word: Alpha-numeric display operating mode

NOTICE	The response to a target write command contains a status word that has not yet been updated.
---------------	--

Type, validity and acknowledgment status of the target values are fed back in the status word. The status word is composed of 16 bits.

Status word																
15	14	13	12	11	10	9	8	7	6	5	4	3	2	1	0	
MSB								Low Byte								LSB

The designation of the individual bits of the control word as well as their meaning:





Bit	Meaning	Value = 0	Value = 1
0	reserved	ever 0	-
1	reserved	ever 0	-
2	Display data activation (display line 1)	Display data deactivated	Activate display data
3	Target value acknowledged (display line 2)	Target value not acknowledged	Target value acknowledged
4	reserved	ever 0	-
5	Display data acknowledged (display line 1)	Display data not acknowledged	Display data acknowledged
6	reserved	ever 0	-
7	General error	No error	An error exists
8	Display data format (display line 1)	Display data are interpreted as a number	Display data are interpreted as an ASCII character
9	Target value format (display line 2)	Target value is interpreted as a number	Target value is interpreted as an ASCII character
10	Target value activation (display line 2)	Target value is deactivated	Target value is activated
11	Battery state	Battery Charging state is OK	Battery Charging state is critical
12	Sensor error	There is no sensor error	There is a sensor error
13	Key Configuration 	Button is not pressed	Button is pressed
14	Key Calibration 	Button is not pressed	Button is pressed
15	Key Incremental 	Button is not pressed	Button is pressed

Table 7: Status word alpha-numeric display operating mode

3.2 Battery buffering

Without an external power supply, encoder changes are recorded with battery support. Depending on the duration of battery operation (including storage) and the frequency of adjustments without an external power supply, the battery life is approximately 8 years.

Battery voltage is checked at intervals of approx. 10 min. If battery voltage drops below a specified value, the battery symbol  will blink on the display. If the battery voltage continues to drop,  will be displayed permanently. The battery should be replaced within approx. three months after the first appearance of the battery symbol. For battery replacement it is mandatory to follow the instructions of the installation instructions. Replacement can also take place at the SIKO distribution partners or in the SIKO main plant.

Behavior of the status word

The charge status of the battery is signified in the status word. In the case of a critical charging voltage, bit 11 is set, and in the case of an empty or non-existing battery, a fault is additionally signaled with bit 7.

3.3 Parameterization of the position indicator



The position indicator can be fully parameterized via the bus interface. All parameters can also be set manually with the help of the keyboard.

3.3.1 Manual parameterization

3.3.1.1 Starting parameterization

The time until menu release is displayed when the  button is pressed. Parameterization starts if it is actuated for the duration of the enable time (see chapter 2.4 and 4.5.14).

3.3.1.2 Value input

Enter values via the  key and the  key. Confirm values entered by pressing the  key.



 - decimal place selection key

 - value input key

3.3.1.3 Value selection

For some parameters you can select values from a list.

Direct value input is not possible there.

Pressing the  key, the value can be selected from the list. By pressing the  key, the selection is confirmed.

3.3.1.4 Overview of the operating menu

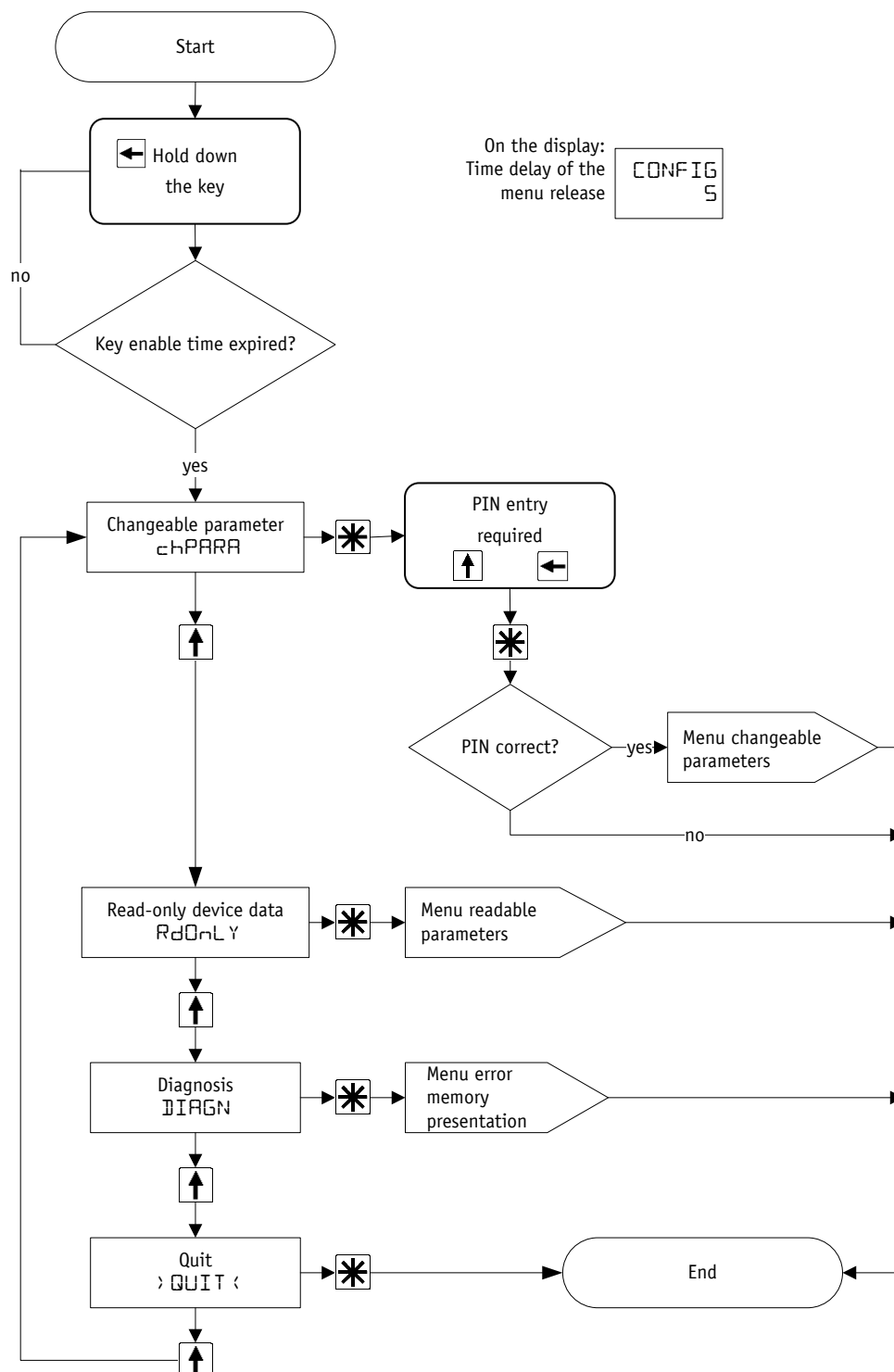

Fig. 6: Operating menu

All device parameters can be viewed and changed in the "Changeable parameters" ("cHPARA") submenu (see chapter 3.3.1.5).

All fixed device data are displayed in the "Readable parameters" (Read Only = "RdONLY") submenu (see chapter 3.5.1).

The "Diagnosis" ("DIAGN") submenu provides various diagnostic options (see chapter 3.5.2).

3.3.1.5 "Changeable parameters" menu

When choosing the "Changeable parameters" submenu, a PIN must be entered first. In the standard delivery condition, this is: "00000".

After confirming the correct PIN, you can choose among the following parameter menus.

Description	Display	Chapter
Quick Setup	QUICK SETUP	3.3.1.6
POWERLINK	SETEPL	3.3.1.7
Positioning	POSI	3.3.1.8
Visualization	VISUAL	3.3.1.9
LED function	LEDS	3.3.1.10
Device options	OPTION	3.3.1.11
Menu end	<QUIT>	

Table 8: "Changeable parameters" menu structure

3.3.1.6 Quick Setup

The following parameters can be set in the QUICK SETUP menu:

Description	Display	Chapter
Display direction	DISPL	4.3.1
Network configuration address	SET ID	Fig. 7
Resolution	RESOL	4.2.1
Decimal places	DEC PL	4.2.2
Counting direction	Cnt DIR	4.2.3
Target window	TW	4.2.6
Restart	RESET YES No	
Menu end	<QUIT>	

Table 9: "QUICK SETUP" menu

3.3.1.7 POWERLINK

The following parameters can be set in the "Interface parameter" menu:

Description	Display	Chapter
Network configuration address	SET ID	Fig. 7
Restart selection	RESET YES No	
Menu end	<QUIT>	

Table 10: "POWERLINK" menu

3.3.1.8 Positioning

The following parameters can be set in the "Positioning" menu:

Description	Display	Chapter
Resolution	RESOL	4.2.1
Decimal places	DEC PL	4.2.2
Display divisor	DISDIV	4.5.9
Counting direction	CntDIR	4.2.3
Enter calibration value	CALVAL	4.2.4
Calibrate selection	CALVAL YES No	
Application Offset	OFFSET	4.2.5
Target window	TW	4.2.6
Extended target window	TWX	4.2.7
Loop positioning	LOOP	4.2.8
Loop length	LOOP L	4.2.9
Menu end	<QUIT>	

Table 11: "Positioning" menu

3.3.1.9 Visualization

The following parameters can be set in the "Visualization" menu:

Description	Display	Chapter
Display orientation	DISPL	4.3.1
Visualization of extended target window	TWXVIS	4.3.4
Direction of rotation indicator	INDICA	4.3.2
Display in the 2 nd row	DLINE2	4.3.3
White display backlight	BL WT	4.3.5
Red display backlight	BL RD	4.3.6
Display backlight blinking	BL FL	4.3.7
Menu end	<QUIT>	

Table 12: "Visualization" menu

3.3.1.10 LED function

The following parameters can be set in the "LED function" menu:

Description	Display	Chapter
LED1 green	LED 1GN	4.4.1
LED1 red	LED 1RD	4.4.2
LED2 green	LED 2GN	4.4.3
LED2 red	LED 2RD	4.4.4

Description	Display	Chapter
LED blinking	LED FL	4.4.5
Menu end	<QUIT>	

Table 13: LED function" menu

3.3.1.11 Device options

The following parameters can be set in the "Additional device options" menu:

Description	Display	Chapter
Restart Selection	RESET YES No	
Key enable time / parameterization delay	K TIME	4.5.11
Calibration enable	K CAL	4.5.13
Incremental measurement enable	K INC	4.5.14
Type of difference calculation	DIFFMD	4.5.7
Operating mode	OPMODE	4.5.1
Display factor	D FACT	4.5.8
Application of the display divisor	DDIVMD	4.5.10
Acknowledgment mode	K ACKN	4.5.15
Mapping channel assignment	GEMAPA	4.5.18
Change the PIN	PIN	4.5.16
Load the factory setting	LOAD P	3.5.3
Input mask for command codes	CODE	4.5.17
Menu end	<QUIT>	

Table 14: "Additional device options" menu

3.3.2 Parameterization via interface

The position indicator can be completely parameterized in the interface (see chapter 5).

3.4 Calibration

Two steps are required for executing calibration:

1. Write calibration value (see parameter [Calibration Value](#))
2. Execute calibration (reset) (via control keys see chapter [2.4](#) or control word Bit 0 = 1 see chapter [3.1.2](#))

Since the measuring system is an absolute system, calibration is necessary only once with commissioning. With calibration, the calibration value is adopted for calculation of the actual value. In the case of calibration (time), the following applies:

Actual value = 0 + calibration value + offset value

Calibration value (see chapter [4.2.4](#))

Offset value (see chapter [4.2.5](#))

3.5 Additional functions

3.5.1 Device data

The following values can be read in the "Read Only" menu:

Description	Display	Chapter
Battery voltage	B VOLT	4.6.1
Operating voltage	OPVOLT	4.6.2
Device temperature	TEMP	
Display of the currently used calibration value	CALACT	
Firmware version number of application	SW APP	
Firmware version number of EPL module	SW RTE	
Serial number	SN DEV	
Production date alternating between year and day/month	P DATE	
ECT parameter	ECT INFO	
Device address	DEV ID	

Table 15: "Device data" menu

3.5.2 Diagnosis

The AP20 features various diagnostic options, which can be selected from the "Diagnosis" submenu. The following diagnostic options are differentiated:

Description	Display	Chapter
Reading the error memories	Error	3.5.2.1
Presentation	PRSENT	3.5.2.2

Table 16: "Diagnosis" menu

3.5.2.1 Reading the error memories

The error history can be output at this point.

The list "AP20" contains faults detected by the device such as "Battery undervoltage" or "Timeout".

With errors occurring, the error number and overall quantity are output on the upper line. The error type appears in the bottom line. The error number 1 contains the oldest error. The most recent error is output with the highest error number. "noErr" appears if no errors have been detected so far.

The error memory of the AP20 can be deleted via the interface with "System command" with data content 8 (see chapter [4.5.21](#)).

3.5.2.2 Presentation

In presentation mode, a fixed target value (850) is set and validated. With it, the device function can be presented without having to specify a target value via an interface. In presentation mode, changes to parameters are not permanently changed in the device memory. Restarting the device will exit presentation mode and reset the device to the last valid configuration.

3.5.3 Restore factory settings

There are various options for restoring the factory settings of the device:

Access	Coding		Factory settings are restored
Manual	CODE (chapter 4.5.17)	1 1 100	all parameters
		1 1 102	all except bus parameters
		1 1 105	only bus parameters
	Load Default	All	all parameters
		Standard	all except bus parameters (standard)
		NETWORK	only bus parameters
Interface (Parameter System Command see chapter 4.5.21)	FFh	1	all parameters
		2	all except bus parameters
		3	only bus parameters

Table 17: Access to factory settings

3.6 Warnings / Errors

3.6.1 Warnings

Warnings do not influence the acquisition of the absolute actual value. Warnings are deleted after removing the cause.

Possible warnings:

- Battery voltage for absolute position detection is below limit ⇒ immediately exchange battery!
This warning is displayed with a blinking battery symbol . Warning messages are output via the interface via the status word.



Display	Bit assignment in the status word	Error
 flashing	Bit 11	Low battery voltage (critical) Actual value is still valid!

Table 18: Warnings

3.6.2 Errors

NOTICE Calibration may also be required Depending on the error type.

Error states are signaled via display (written in red or battery symbol) and interface. To return to normal operation, the cause must be removed. Error signaling (display flashes red) can then be acknowledged or deleted with the  button or via the interface.

If calibration is required, this is indicated in the display as "CALIB REQUEST". Independent of acknowledgment of the error status.

All sensor and velocity disturbances are detected and output with a delay of up to 10 s.



Display	Error code		Bit assignment in the status word	Error
	EPL-Interface	Web server		
 permanent	0x0006h	6	Bit 11 & Bit 7	Battery undervoltage (dead)
SPEED	0x0019h	25	Bit 12 & Bit 7	Travel speed exceeded
SEnSIC	0x0020h	32	Bit 7	Sensor chip error
TOCYcL	0x0081h	129	Bit 7	Timeout EPL interface
M WDER	0x0014h	20	Bit 7	Ethernet module "Watchdog" error
M ERRO	0x0015h	21	Bit 7	Error in Ethernet module runtime
M EXCE	0x00FEh	254	Bit 7	Error in the Ethernet module in the "Exception" state
None	0x0013h	19	Bit 7	EEPROM read/write error

Table 19: Error messages

Display	Error	Possible effect	Corrective actions
 permanent	Battery empty	Actual value not reliable	Battery change + calibration travel
SPEED	Permissible travel speed exceeded (see installation instruction)	Actual value not reliable	Traversing speed + calibration travel
SEnSIC	Communication sensor chip defective	No valid position values	Internal error
TOCYcL	Timeout in acyclic data exchange	Communication error	Check cycle time of the controller
M WDER	Ethernet-Module Watchdog	Communication error	Internal error
M ERRO	Ethernet module in the ERROR state during an active travel order	Communication error	Internal error
M EXCE	Ethernet module in the "Exception" state	Communication error	Internal error The behavior of the position display when this fault occurs can be determined with this parameter System Configuration, bit 6 (see chapter 4.5.19).

Display	Error	Possible effect	Corrective actions
None	EEPROM read/write error	Incorrect parameterization at restart	Contact support

Table 20: Corrective actions

A list of errors that occurred can be read in the Diagnosis/Error memory operating menu (see chapter 3.5.2.1). This error memory can be deleted via the EPL interface with the system command FFh with data content.

4 Parameters

Parameters are classified. The classes E, N, S, V and PD can be separately reset to factory settings if necessary (see chapter 3.5.3).

Parameter classes	Character
Error memory	E
Network parameters	N
Standard parameters	S
Visualization parameters	V
Process data	PD

Chapter	starting with page
Network configuration	70
Positioning	29
Visualization	37
LEDs	41
Options	44
Device information	58
Error memory	64

4.1 Parameter overview

Name	Description	see page
2001h: Control Word	Control word	35
2002h: Display Data	Display content in display mode	45
2003h: Target Value	Target value	36
2004h: Status Word	Status word	35
2005h: Actual Value	Actual value	36
2007h: Generic Mapping Channel	Selectable data channel	63
2008h: Error Status	Error status	69
200Ah: Module Parameters	Internal parameter of the network module	57
200Ch: Generic Mapping Parameter	Data channel selection parameter	55

Name	Description	see page
2012h: PIN Change	Menu lock code	54
2013h: Key Enable Time	Time period, during which the button must be pressed to start parameterization.	51
2014h: Key Calibration	Key to trigger calibration	52
2015h: Key Incremental	Key to trigger increment	53
2016h: Key Configuration	Key to trigger configuration	52
2018h: Key Acknowledgment Mode	Key to trigger acknowledgment	54
2019h: Decimal Places	Number of decimal places	30
201Ah: Display Divisor	Display divisor ADI	50
201Bh: Direction Indicators	Display of the direction indicators	38
201Ch: Display Orientation	Display orientation	37
201Dh: Resolution	Resolution	29
201Eh: Counting Direction	Counting direction	31
202Dh: Offset Application	The offset value is added to the position value in the encoder.	32
202Eh: Calibration Value	The calibration value is set during calibration.	31
2030h: Loop Type	Direction in which the target value is approached.	33
2031h: Loop Length	Loop length (clearance compensation)	34
2032h: Target Window	If the actual value lies within the target window, the target value is reached.	32
2033h: Target Window Extended	Extended target window for better positioning at high travel speed.	33
2034h: Target Window Extended Visualization	Visualization of extended target window	39
2037h: Operating Mode	Operating mode	44
2038h: Display Factor	Display factor	48
2039h: Display String Mode	Display mode operation	45
203Ah: Display String1	Data content line 1 with active display string mode	46
203Bh: Display String2	Data content line 2 with active display string mode	47
203Fh: Displayed Value 2nd Line	Controls the display of the 2nd line of the display	38
2042h: Display Divisor Mode	Application of the display divisor ADI	51
2043h: Difference Value Mode	Formation of the differential value	48
2044h: Active LED Flashing	Flashing of all LEDs	44
2045h: LED1 Green Mode	LED1 green mode	41
2046h: LED1 Red Mode	LED1 red mode	42
2047h: LED2 Green Mode	LED2 green mode	42
2048h: LED2 Red Mode	LED2 red mode	43
2049h: Active LCD Backlight Flashing	Flashing of the LCD backlight	41

Name	Description	see page
204Ah: Active LCD Backlight White	LCD backlight white	39
204Bh: Active LCD Backlight Red	LCD backlight red	40
2061h: Device Identification	Device type number	63
2062h: Software Version Application	Software version of the device	60
2063h: Serial Number	Serial number	61
2064h: Production Date	Production date	62
2080h: Error Count	Error counter	64
2081h: Error Number 1	Error memory 1	64
2082h: Error Number 2	Error memory 2	65
2083h: Error Number 3	Error memory 3	65
2084h: Error Number 4	Error memory 4	66
2085h: Error Number 5	Error memory 5	66
2086h: Error Number 6	Error memory 6	67
2087h: Error Number 7	Error memory 7	67
2088h: Error Number 8	Error memory 8	68
2089h: Error Number 9	Error memory 9	68
208Ah: Error Number 10	Error memory 10	69
20C1h: Speed Value	Speed monitoring	36
20C3h: Difference Value	Difference value between actual value and target value. Depending on the mode (Difference Value Mode)	47
20C4h: Battery Voltage	Battery voltage	58
20C5h: Operation Voltage	Operating voltage	59
20E0h: Message Control Timeout	Network communication monitoring time	
20FEh: System Configuration	Network module configuration	56
20FFh: System Command	System command	57

Table 21: Parameter description

4.2 Positioning

4.2.1 Resolution

This parameter determines the number of measurement steps per revolution (display/revolution = APU).

General characteristics

EEPROM	yes
Class	S
Unit	-

POWERLINK

Data type	UNSIGNED32
Access	rw
Object	201Dh
Sub-index	00h

Display

Menu	RESOL (cHPARA \ POSI \ RESOL)
------	-------------------------------

Data type UNSIGNED32

Value range	1 ... 65535
Default	880 (default)

4.2.2 Decimal Places

General characteristics

EEPROM	yes
Class	V
Unit	-

POWERLINK

Data type	UNSIGNED8
Access	rw
Object	2019h
Sub-index	00h

Display

Menu	DEC PL (cHPARA \ POSI \ DEC PL)
------	---------------------------------

Data type UNSIGNED8

Value range	0 ... 4
Default	0 (default)

Parameter selection

Value	Display	Description
0	0	0
1	0.1	0.1
2	0.02	0.02
3	0.003	0.003
4	0.0004	0.0004

4.2.3 Counting Direction

General characteristics

EEPROM	yes
Class	S
Unit	-

POWERLINK

Data type	UNSIGNED8
Access	rw
Object	201Eh
Sub-index	00h

Display

Menu	C _n +DIR (chPARAM \ POSI \ C _n +DIR)
------	--

Data type UNSIGNED8

Value range	0 ... 1
Default	0 (default)

Parameter selection

Value	Display	Description
0	CW	clockwise
1	CCW	counter-clockwise

CW counting direction: ascending position values with clockwise shaft rotation (CW, view on the display).

CCW counting direction: ascending position values with counter-clockwise shaft rotation (CCW, view on the display).

4.2.4 Calibration Value

The current calibration value is always displayed in the ReadOnly menu (see chapter 3.5.1); it is always replaced with the parameter value only after an executed calibration.

To perform a calibration, the system command "Calibration" must be executed (see chapter 3.4).

General characteristics

EEPROM	yes
Class	S
Unit	-

POWERLINK

Data type	INTEGER32
Access	rw
Object	202Eh
Sub-index	00h

Display

Menu	CALVAL (CHPARAM \ POSI \ CALVAL)
------	----------------------------------

Data type INTEGER32

Value range	-999999 ... 999999
Default	0 (default)

4.2.5 Offset Application

This parameter sets the offset value.

With the offset, it is possible to move the scaled value range. The offset value is added to the position value in the encoder. Both positive and negative values are permitted. Position value = measurement value + calibration value.

General characteristics

EEPROM	yes
Class	S
Unit	-

POWERLINK

Data type	INTEGER16
Access	rw
Object	202Dh
Sub-index	00h

Display

Menu	OFFSET (CHPARAM \ POSI \ OFFSET)
------	----------------------------------

Data type INTEGER16

Value range	-29999 ... 29999
Default	0 (default)

4.2.6 Target Window

If the actual value lies within the target window, the target value is reached.

General characteristics

EEPROM	yes
Class	S
Unit	User units

POWERLINK

Data type	UNSIGNED16
Access	rw
Object	2032h
Sub-index	00h

Display

Menu	TW (cHPARA \ POSI \ TW)
------	-------------------------

Data type UNSIGNED16

Value range	0 ... 9999
Default	5 (default)

4.2.7 Target Window Extended

Extended target window for better positioning at high travel speed.

General characteristics

EEPROM	yes
Class	S
Unit	User units

POWERLINK

Data type	UNSIGNED16
Access	rw
Object	2033h
Sub-index	00h

Display

Menu	TWX (cHPARA \ POSI \ TWX)
------	---------------------------

Data type UNSIGNED16

Value range	0 ... 9999
Default	0 (default)

4.2.8 Loop Type

This parameter specifies the positioning type, the loop type. This selects the direction in which the target value is to be approached.

General characteristics

EEPROM	yes
Class	S
Unit	-

POWERLINK

Data type	UNSIGNED8
Access	rw
Object	2030h
Sub-index	00h

Display

Menu	LOOP (cHPARA \ POSI \ LOOP)
------	-----------------------------

Data type UNSIGNED8

Value range	0 ... 2
Default	0 (default)

Parameter selection

Value	Display	Description
0	DIR	direct, no loop
1	CW	clockwise
2	CCW	counter-clockwise

4.2.9 Loop Length

General characteristics

EEPROM	yes
Class	S
Unit	User units

POWERLINK

Data type	UNSIGNED16
Access	rw
Object	2031h
Sub-index	00h

Display

Menu	LOOP L (cHPARA \ POSI \ LOOP L)
------	---------------------------------

Data type UINT

Value range	0 ... 9999
Default	0 (default)

4.2.10 Control Word

General characteristics

EEPROM	no
Class	PD
Unit	-

POWERLINK

Data type	UNSIGNED16
Access	rw
Object	2001h
Sub-index	00h

Display

Menu	
------	--

Data type UNSIGNED16

Value range	-
Default	no default

4.2.11 Status Word

General characteristics

EEPROM	no
Class	PD
Unit	-

POWERLINK

Data type	UNSIGNED16
Access	ro
Object	2004h
Sub-index	00h

Display

Menu	
------	--

Data type UNSIGNED16

Value range	0 ... 65535
Default	0 (default)

4.2.12 Target Value

General characteristics

EEPROM	no
Class	PDO
Unit	-

POWERLINK

Data type	INTEGER32
Access	rw
Object	2003h
Sub-index	00h

Display

Menu	
------	--

Data type INTEGER32

Value range	-2147483648 ... 2147483647
Default	0 (default)

4.2.13 Actual Value

General characteristics

EEPROM	no
Class	PD
Unit	-

POWERLINK

Data type	INTEGER32
Access	ro
Object	2005h
Sub-index	00h

Display

Menu	
------	--

Data type INTEGER32

Value range	-5242880 ... 5242880
Default	0 (default)

4.2.14 Speed Value

Display of the rotation speed directly or as a generic mapping parameter (see chapter [4.5.18](#)).

General characteristics

EEPROM	no
Class	-
Unit	U/Min

POWERLINK

Data type	INTEGER32
Access	ro
Object	20C1h
Sub-index	00h

Display

Menu	
------	--

Data type INTEGER32

Value range	-503316 ... 503316
Default	0 (default)

4.3 Visualization

4.3.1 Display Orientation

General characteristics

EEPROM	yes
Class	V
Unit	-

POWERLINK

Data type	UNSIGNED8
Access	rw
Object	201Ch
Sub-index	00h

Display

Menu	DISPL (cHPARA \ VISUAL \ DISPL)
------	---------------------------------

Data type UNSIGNED8

Value range	0 ... 1
Default	0 (default)

Parameter selection

Value	Display	Description
0	<input type="checkbox"/>	0° not rotated
1	<input type="checkbox"/>	180° rotated

4.3.2 Direction Indicators

Display of the direction indicators (CW, CCW).

General characteristics

EEPROM	yes
Class	V
Unit	-

POWERLINK

Data type	UNSIGNED8
Access	rw
Object	201Bh
Sub-index	00h

Display

Menu	INDICA (CHPARAM \ VISUAL \ INDICA)
------	------------------------------------

Data type UNSIGNED8

Value range	0 ... 2
Default	0 (default)

Parameter selection

Value	Display	Description
0	ON	On
1	INV	Inverted
2	OFF	Off

4.3.3 Displayed Value 2nd Line

General characteristics

EEPROM	yes
Class	V
Unit	-

POWERLINK

Data type	UNSIGNED8
Access	rw
Object	203Fh
Sub-index	00h

Display

Menu	DLINE2 (CHPARAM \ VISUAL \ DLINE2)
------	------------------------------------

Data type UNSIGNED8

Value range	0 ... 1
Default	0 (default)

Parameter selection

Value	Display	Description
0	POSIVRL	Target value or difference value
1	OFF	deactivated

4.3.4 Target Window Extended Visualization

General characteristics

EEPROM	yes
Class	S
Unit	-

POWERLINK

Data type	UNSIGNED8
Access	rw
Object	2034h
Sub-index	00h

Display

Menu	TWXVIS (CHPARAM \ VISUAL \ TWXVIS)
------	------------------------------------

Data type UNSIGNED8

Value range	0 ... 1
Default	0 (default)

Parameter selection

Value	Display	Description
0	OFF	Off
1	ON	On

4.3.5 Active LCD Backlight White

General characteristics

EEPROM	Yes
Class	V
Unit	-

POWERLINK

Data type	UNSIGNED8
Access	rw
Object	204Ah
Sub-index	00h

Display

Menu	BL WT (cHPARA \ VISUAL \ BL WT)
------	---------------------------------

Data type UNSIGNED8

Value range	0 ... 1
Default	1 (default)

Parameter selection

Value	Display	Description
0	OFF	Off
1	ON	On

4.3.6 Active LCD Backlight Red

General characteristics

EEPROM	yes
Class	V
Unit	-

POWERLINK

Data type	UNSIGNED8
Access	rw
Object	204Bh
Sub-index	00h

Display

Menu	BL RD (cHPARA \ VISUAL \ BL RD)
------	---------------------------------

Data type UNSIGNED8

Value range	0 ... 1
Default	1 (default)

Parameter selection

Value	Display	Description
0	OFF	Off
1	ON	On

4.3.7 Active LCD Backlight Flashing

General characteristics

EEPROM	yes
Class	V
Unit	-

POWERLINK

Data type	UNSIGNED8
Access	rw
Object	2049h
Sub-index	00h

Display

Menu	BL FL (CHPARAM \ VISUAL \ BL FL)
------	----------------------------------

Data type UNSIGNED8

Value range	0 ... 1
Default	0 (default)

Parameter selection

Value	Display	Description
0	OFF	Off
1	ON	On

4.4 LEDs

4.4.1 LED1 Green Mode

General characteristics

EEPROM	yes
Class	V
Unit	-

POWERLINK

Data type	UNSIGNED8
Access	rw
Object	2045h
Sub-index	00h

Display

Menu	LED 1GN (CHPARAM \ LEIDS \ LED 1GN)
------	-------------------------------------

Data type UNSIGNED8

Value range	0 ... 1
Default	1 (default)

Parameter selection

Value	Display	Description
0	CRWORD	Control word
1	POS	Position

4.4.2 LED1 Red Mode

General characteristics

EEPROM	yes
Class	V
Unit	-

POWERLINK

Data type	UNSIGNED8
Access	rw
Object	2046h
Sub-index	00h

Display

Menu	LED 1RD (CHPARAM \ LEDS \ LED 1RD)
------	------------------------------------

Data type UNSIGNED8

Value range	0 ... 1
Default	1 (default)

Parameter selection

Value	Display	Description
0	CRWORD	Control word
1	POS	Position

4.4.3 LED2 Green Mode

General characteristics

EEPROM	yes
Class	V
Unit	-

POWERLINK

Data type	UNSIGNED8
Access	rw
Object	2047h
Sub-index	00h

Display

Menu	LED2GN (CHPARAM \ LEIS \ LED2GN)
------	----------------------------------

Data type UNSIGNED8

Value range	0 ... 1
Default	1 (default)

Parameter selection

Value	Display	Description
0	CRWORD	Control word
1	POS	Position

4.4.4 LED2 Red Mode

General characteristics

EEPROM	yes
Class	V
Unit	-

POWERLINK

Data type	UNSIGNED8
Access	rw
Object	2048h
Sub-index	00h

Display

Menu	LED2RD (CHPARAM \ LEIS \ LED2RD)
------	----------------------------------

Data type UNSIGNED8

Value range	0 ... 1
Default	1 (default)

Parameter selection

Value	Display	Description
0	CRWORD	Control word
1	POS	Position

4.4.5 Active LED Flashing

General characteristics

EEPROM	yes
Class	V
Unit	-

POWERLINK

Data type	UNSIGNED8
Access	rw
Object	2044h
Sub-index	00h

Display

Menu	LED FL (cHPARA \ LEDS \ LED FL)
------	---------------------------------

Data type UNSIGNED8

Value range	0 ... 1
Default	0 (default)

Parameter selection

Value	Display	Description
0	OFF	No flashing, LEDs light when active
1	ON	LEDs flash when active

4.5 Options

4.5.1 Operating Mode

General characteristics

EEPROM	yes
Class	S
Unit	-

POWERLINK

Data type	UNSIGNED8
Access	rw
Object	2037h
Sub-index	00h

Display

Menu	OPMODE (cHPARA \ OPTION \ OPMODE)
------	-----------------------------------

Data type UNSIGNED8

Value range	0 ... 3
Default	0 (default)

Parameter selection

Value	Display	Description
0	ABSPOS	Absolute position
1	DIFF	Difference value
2	MODULO	Modulo (360° angle display)
3	DISPL	Alpha-numeric display

After each change between "Absolute position" and "Modulo" a device restart is required.

4.5.2 Display Data

If the target value is used for displaying (Display String Mode = 0), the data format can be selected between decimal or ASCII using the control word Bit8 Display data type and Bit9 Target value type.

General characteristics

EEPROM	no
Class	PD
Unit	-

POWERLINK

Data type	INTEGER32
Access	rw
Object	2002h
Sub-index	00h

Display

Menu	
------	--

Data type INTEGER32

Value range	$-2^{31} \dots 2^{31}-1$
Default	0 (default)

4.5.3 Display String Mode

In the **alphanumeric display** mode, this parameter selects the data source for the display. The Display String Mode = 1 is set to display Display String1 and Display String2. This is only possible when the data type ASCII is active; for this purpose, Bit7 = 1 or Bit8 = 1 must be set in the control word. As a result, it is possible to display 6 ASCII characters per line. Otherwise, the Target Value process data and Display Data are displayed.

General characteristics

EEPROM	yes
Class	V
Unit	-

POWERLINK

Data type	UNSIGNED8
Access	rw
Object	2039h
Sub-index	00h

Display

Menu	
------	--

Data type UNSIGNED8

Value range	0 ... 1
Default	0 (default)

Parameter selection

Value	Description
0	Target Value process data and Display Data are used as display value.
1	Display String1 and Display String2 are shown on the display.

4.5.4 Display String1

Data contents Line 1 with active display string mode.

General characteristics

EEPROM	no
Class	V
Unit	-

POWERLINK

Data type	UNSIGNED32
Access	rw
Object	203Ah
Sub-index	00h

Display

Menu	
------	--

Data type UNSIGNED32

Value range	0 ... 4294967295
Default	0 (default)

4.5.5 Display String2

Data content line 2 with active display string mode.

General characteristics

EEPROM	no
Class	V
Unit	-

POWERLINK

Data type	UNSIGNED32
Access	rw
Object	203Bh
Sub-index	00h

Display

Menu	
------	--

Data type UNSIGNED32

Value range	0 ... 4294967295
Default	0 (default)

4.5.6 Difference Value

The difference value can be read with this parameter. The formation of the difference value is set with the Difference Value Mode parameter.

General characteristics

EEPROM	no
Class	-
Unit	-

POWERLINK

Data type	INTEGER32
Access	ro
Object	20C3h
Sub-index	00h

Display

Menu	
------	--

Data type INTEGER32

Value range	-5242880 ... 5242880
Default	0 (default)

4.5.7 Difference Value Mode

General characteristics

EEPROM	yes
Class	V
Unit	-

POWERLINK

Data type	UNSIGNED8
Access	rw
Object	2043h
Sub-index	00h

Display

Menu	DIFFMD (CHPARAM \ VISUAL \ DIFFMD)
------	------------------------------------

Data type UNSIGNED8

Value range	0 ... 1
Default	0 (default)

Parameter selection

Value	Display	Description
0	POS-TR	DIFF = Actual - Target
1	TR-POS	DIFF = Target - Actual

4.5.8 Display Factor

If a display factor > 0 is set, all values on the display are indicated in inch.

It should be noted that the transmission values from and to the interface are present in the metric system (depending on resolution and ADI). The control delivers target, calibration and offset values as well as loop length and target window metrically as well. Device-internal position monitoring is metrical. Therefore, the superordinate control can only function in the metric system. The values for position, target value and the differential value if applicable are calculated by means of the following formula (for position value):

Display value = position value x calculation factor

$$\text{Calculation factor} = \frac{1}{0.254} \times 10^{4-\text{Display factor}}$$

9 different calculation factors can be set (see [Table 22](#)). The number of decimal places is selected via parameter Decimal Places.

A change to the parameter only takes effect after a device restart.

Display factor	Calculation factor	Meaning	Examples of indication (Resolution = 400) Position after 1 revolution = 400
0	1	Metric indication after APU and ADI	400
1	$\frac{10^3}{0.254} = \frac{1000}{0.254}$	Imperial indication (inch)	1574803
2	$\frac{10^2}{0.254} = \frac{100}{0.254}$		157480
3	$\frac{10^1}{0.254} = \frac{10}{0.254}$		15748
4	$\frac{10^0}{0.254} = \frac{1}{0.254}$		1575
5	$\frac{10^{-1}}{0.254} = \frac{0.1}{0.254}$		158
6	$\frac{10^{-2}}{0.254} = \frac{0.01}{0.254}$		16
7	$\frac{10^{-3}}{0.254} = \frac{0.001}{0.254}$		2
8	$\frac{10^{-4}}{0.254} = \frac{0.0001}{0.254}$		0

Table 22: Value table of display factor

General characteristics

EEPROM	yes
Class	S
Unit	User units

POWERLINK

Data type	UNSIGNED8
Access	rw
Object	2038h
Sub-index	00h

Display

Menu	Ⓜ FACT (CHPARAM \ OPTION \ Ⓜ FACT)
------	------------------------------------

Data type UNSIGNED8

Value range	0 ... 8
Default	0 (default)

4.5.9 Display Divisor

General characteristics

EEPROM	yes
Class	V
Unit	-

POWERLINK

Data type	UNSIGNED8
Access	rw
Object	201Ah
Sub-index	00h

Display

Menu	DISDIV (CHPARAM \ POSI \ DISDIV)
------	----------------------------------

Data type UNSIGNED8

Value range	0 ... 3
Default	0 (default)

Parameter selection

Value	Display	Description
0	1	1
1	10	10
2	100	100
3	1000	1000

Examples:

(Application of the Display Divisor see chapter 4.3.4)

Position value ascertained	DISDIV (12h)	DISDIVMOD-application (25h)	Display	Output interface	Target value received	Target attained
12348	2	0	123	123	123	yes
12348	2	1	123	12348	123	yes
12348	2	1	123	12348	12348	no
12348	1	2	1235	12348	12348	yes
12348	1	2	1235	12348	1235	no
12348	3	2	12	12348	12348	yes
12348	3	2	12	12348	1235	no

Table 23: ADI and ADI application

4.5.10 Display Divisor Mode

This parameter can be used to set the application of the display divisor for the determined position values (absolute position value, frozen position value) as well as the received target value (display divisor and examples see chapter 4.5.9).

General characteristics

EEPROM	yes
Class	V
Unit	-

POWERLINK

Data type	UNSIGNED8
Access	rw
Object	2042h
Sub-index	00h

Display

Menu	DDIVMD (CHPARAM \ OPTION \ DDIVMD)
------	------------------------------------

Data type UNSIGNED8

Value range	0 ... 2
Default	0 (default)

Parameter selection

Value	Display	Description
0	ALL	Display, target value and interface output are calculated with the divisor.
1	DI + TAR	Display and target value are calculated with the divisor.
2	DISPL	Display is calculated with the divisor.

4.5.11 Key Enable Time

This parameter sets the delay of the display of the parameter menu (release time buttons).

General characteristics

EEPROM	yes
Class	V
Unit	-

POWERLINK

Data type	UNSIGNED8
Access	rw
Object	2013h
Sub-index	00h

Display

Menu	K TIME (CHPARAM \ OPTION \ K TIME)
------	------------------------------------

Data type UNSIGNED8

Value range	1 ... 60
Default	5 (default)

4.5.12 Key Configuration

With this parameter, the parameterization is enabled at pressing of a key.

If the configuration is locked, a CODE query is displayed instead to be able to unlock a locked position display manually (see chapter 3.5.3).

General characteristics

EEPROM	yes
Class	V
Unit	-

POWERLINK

Data type	UNSIGNED8
Access	rw
Object	2016h
Sub-index	00h

Display

Menu	
------	--

Data type UNSIGNED8

Value range	0 ... 1
Default	1 (default)

4.5.13 Key Calibration

This parameter specifies whether the calibration of the position value is enabled by pressing a key.

General characteristics

EEPROM	yes
Class	V
Unit	-

POWERLINK

Data type	UNSIGNED8
Access	rw
Object	2014h
Sub-index	00h

Display

Menu	K CAL (cHPARA \ OPTION \ K CAL)
------	---------------------------------

Data type UNSIGNED8

Value range	0 ... 1
Default	1 (default)

Parameter selection

Value	Display	Description
0	DISABL	Blocked
1	ENABLE	Release

4.5.14 Key Incremental

This parameter specifies whether the setting of the position value is enabled by pressing a key.

General characteristics

EEPROM	yes
Class	V
Unit	-

POWERLINK

Data type	UNSIGNED8
Access	rw
Object	2015h
Sub-index	00h

Display

Menu	K INC (cHPARA \ OPTION \ K INC)
------	---------------------------------

Data type UNSIGNED8

Value range	0 ... 1
Default	1 (default)

Parameter selection

Value	Display	Description
0	DISABL	Blocked
1	ENABLE	Released

4.5.15 Key Acknowledgment Mode

This parameter can be used to specify which key is to be used as an acknowledgment key. The setting is only relevant in the **alphanumeric display** mode. In this case, a received target value is displayed flashing until its reception is acknowledged by the pressing of a button.

General characteristics

EEPROM	yes
Class	V
Unit	-

POWERLINK

Data type	UNSIGNED8
Access	rw
Object	2018h
Sub-index	00h

Display

Menu	K ACKN (CHPARAM \ OPTION \ K ACKN)
------	------------------------------------

Data type UNSIGNED8

Value range	0 ... 1
Default	0 (default)

Parameter selection

Value	Display	Description
0	ASTERX	Asterisk key ⇔ * - key
1	ARROW	Arrow key ⇔ ↑ - and ← -key

4.5.16 PIN Change

General characteristics

EEPROM	yes
Class	V
Unit	-

POWERLINK

Data type	INTEGER32
Access	rw
Object	2012h
Sub-index	00h

Display

Menu	PIN (CHPARAM \ OPTION \ PIN)
------	------------------------------

Data type INTEGER32

Value range	0 ... 99999
Default	0 (default)

4.5.17 CODE Input

The code can only be entered on the device. Either via the parameter menu options or with Key Configuration is the key is locked.

General characteristics

EEPROM	no
Class	-
Unit	-

POWERLINK

Data type	INTEGER32
Access	wo
Object	-
Sub-index	00h

Display

Menu	CODE (cHPARAM \ OPTION \ CODE)
------	--------------------------------

Data type INTEGER32

Value range	0 ... 999999
Default	0 (default)

Parameter selection

Value	Display	Description
100	000 100	Start alignment process
11100	0 1 1 100	Reset, all parameters
11102	0 1 1 102	Reset, all, except interface parameters
11105	0 1 1 105	Reset, interface parameters only

4.5.18 Generic Mapping Parameter

This parameter defines the content of the generic mapping channel, which is part of the process data.

General characteristics

EEPROM	yes
Class	N
Unit	-

POWERLINK

Data type	UNSIGNED8
Access	rw
Object	200Ch
Sub-index	00h

Display

Menu	GEMAPA (cHPARA \ OPTION \ CODE)
------	---------------------------------

Data type UNSIGNED8

Value range	0 ... 8
Default	0 (default)

Parameter selection

Value	Display	Description
0	TARGET	Target Value
1	OPVOLT	Operating voltage
2	B VOLT	Battery voltage
3	SPEED	Sensor speed
4	SENADC	Sensor raw data
5	PERCNT	Sensor rough value
6	OPTIME	Operating hours
7	DIFF	Difference value depending on mode
8	TEMP	Temperature

4.5.19 System Configuration

General characteristics

EEPROM	yes
Class	S
Unit	-

POWERLINK

Data type	UNSIGNED16
Access	rw
Object	20FEh
Sub-index	00h

Display

Menu	SYSCON (cHPARA \ OPTION \ SYSCON)
------	-----------------------------------

Data type UNSIGNED16

Value range	0 ... 127
Default	15 (default)

Parameter selection

Bit	Description
0	SHICP (Secure Host IP Configuration Protocol) 0 = switched off 1 = switched on (default) Changes are only adopted after reset.
1	Web server 0 = switched off 1 = switched on (default) Changes are only adopted after reset.
2	Parameter access via web server 0 = switched off 1 = switched on (default) Changes are only adopted after reset.
3	FTP Server 0 = switched off 1 = switched on (default) Changes are only adopted after reset.
4	FTP Server administrator rights 0 = no (default) 1 = yes Changes are only adopted after reset.
5	Reserved, ever 0
6	Auto reset in the EXCEPTION state 0 = switched off (default): In the EXCEPTION state, the position indicator stops participating in network traffic and can no longer be addressed. To exit this state, a Power On Reset is required. 1 = switched on: In the EXCEPTION state, the position indicator automatically performs a reset. After the restart, the EXCEPTION fault is triggered.
7 ... 15	Reserved, ever 0

4.5.20 Module Parameters

This parameter module parameters is for internal purposes only, and may not be described.

General characteristics

EEPROM	no
--------	----

4.5.21 System Command

General characteristics

EEPROM	no
Class	-
Unit	-

POWERLINK

Data type	UNSIGNED8
Access	wo
Object	20FFh
Sub-index	00h

Display

Menu	
------	--

Data type UNSIGNED8

Value range	0 ... 100
Default	0 (default)

Parameter selection

Value	Description
1	Set all parameters to factory settings
2	Only set standard parameters to factory settings
3	Only set network parameters to factory settings
6	Acknowledge error
7	Calibrate
8	Delete error memory
9	Software reset (warm start)
100	Start sensor alignment

4.6 Device information

4.6.1 Battery Voltage

This parameter can be used to read the battery voltage. The voltage is output in 10 mV resolution.

General characteristics

EEPROM	no
Class	-
Unit	Volt

POWERLINK

Data type	UNSIGNED16
Access	ro
Object	20C4h
Sub-index	00h

Display

Menu	B VOLT (RDONLY \ B VOLT)
------	--------------------------

Data type UNSIGNED16

Value range	0 ... 65535
Default	0 (default)

4.6.2 Operation Voltage

This parameter can be used to read the operating voltage. The voltage is output in 10 mV resolution.

General characteristics

EEPROM	no
Class	-
Unit	Volt

POWERLINK

Data type	UNSIGNED16
Access	ro
Object	20C5h
Sub-index	00h

Display

Menu	OPVOLT (RDONLY \ OPVOLT)
------	--------------------------

Data type UNSIGNED16

Value range	0 ... 65535
Default	0 (default)

4.6.3 Temperature

The device temperature can be read in the Readonly menu and in the Generic Generic Mapping Channel. The temperature is output in 0.1 °C resolution.

General characteristics

EEPROM	no
Class	-
Unit	°C

POWERLINK

Data type	UNSIGNED16
Access	-
Object	-
Sub-index	00h

Display

Menu	TEMP (RDONLY \ TEMP)
------	----------------------

Data type UNSIGNED16

Value range	0 ... 65535
Default	0 (default)

4.6.4 Actual Calibration Value

The Readonly menu displays the currently used calibration value, regardless of the Calibration Value (see chapter 4.2.4), only after a calibration to the current calibration value has been carried out.

General characteristics

EEPROM	yes
Class	S
Unit	-

POWERLINK

Data type	UNSIGNED32
Access	-
Object	-
Sub-index	00h

Display

Menu	ACTCAL (RdONLY \ ACTCAL)
------	--------------------------

Data type UNSIGNED32

Value range	-999999 ... 999999
Default	0 (default)

4.6.5 Software Version Application

General characteristics

EEPROM	yes
Class	-
Unit	-

POWERLINK

Data type	UNSIGNED16
Access	ro
Object	2062h
Sub-index	00h

Display

Menu	SW APP (RdONLY \ SW APP)
------	--------------------------

Data type UNSIGNED16

Value range	1 ... 999
Default	1 (default)

4.6.6 Software Version Ethernet Module

The version is displayed as a 3 byte value xxh:xxh:xxh.

General characteristics

EEPROM	yes
Class	-
Unit	-

POWERLINK

Data type	UNSIGNED32
Access	-
Object	-
Sub-index	00h

Display

Menu	SW RTE (RdONLY \ SW RTE)
------	--------------------------

Data type UNSIGNED32

Value range	0 ... 4294967295
Default	-

4.6.7 Serial Number

General characteristics

EEPROM	yes
Class	-
Unit	-

POWERLINK

Data type	UNSIGNED32
Access	ro
Object	2063h
Sub-index	00h

Display

Menu	SN DEV (RdONLY \ SN DEV)
------	--------------------------

Data type UNSIGNED32

Value range	0 ... 4294967295
Default	0 (default)

4.6.8 Production Date

General characteristics

EEPROM	yes
Class	-
Unit	-

POWERLINK

Data type	UNSIGNED32
Access	ro
Object	2064h
Sub-index	00h

Display

Menu	P DATE (RdONLY \ P DATE)
------	--------------------------

Data type UNSIGNED32

Value range	0 ... 4294967295
Default	0 (default)

4.6.9 MAC Address

The 3 bytes of the 6 byte large MAC address is displayed alternately.

MAC LO corresponds to the 3 lower bytes of the MAC address.

MAC HI corresponds to the 3 higher bytes of the MAC address.

General characteristics

EEPROM	yes (network module)
Class	-
Unit	-

POWERLINK

Data type	UNSIGNED32
Access	-
Object	-
Sub-index	00h

Display

Menu	MAC LO(HI) (RdONLY \ MAC LO, MAC HI)
------	--------------------------------------

Data type UNSIGNED32

Value range	0 ... 4294967295
Default	0 (default)

4.6.10 Device Identification

General characteristics

EEPROM	yes
Class	-
Unit	-

POWERLINK

Data type	UNSIGNED32
Access	ro
Object	2061h
Sub-index	00h

Display

Menu	
------	--

Data type UNSIGNED32

Value range	1 ... 8
Default	4 (default) = AP20

4.6.11 Generic Mapping Channel

In the general data channel, device information can be transmitted as part of the process data.

General characteristics

EEPROM	no
Class	PD
Unit	-

POWERLINK

Data type	INTEGER32
Access	ro
Object	2007h
Sub-index	00h

Display

Menu	
------	--

Data type INTEGER32

Value range	-2147483648 ... 2147483647
Default	0 (default)

4.7 Error Memory

Error display see chapter 3.5.2.1. The current error can be found under the parameter name 08h, and the most recent fault under the highest address. Error types see Table 19.

4.7.1 Error Count

See chapter 3.6.

General characteristics

EEPROM	no
Class	E
Unit	-

POWERLINK

Data type	UNSIGNED8
Access	ro
Object	2080h
Sub-index	00h

Display

Menu	Er "X"/"n" (DIAGN \ Error \ Er "X"/"n" oder noErr)
------	--

Data type UNSIGNED8

Value range	0 ... 10
Default	0 (default)

4.7.2 Error Number 1

General characteristics

EEPROM	yes
Class	E
Unit	-

POWERLINK

Data type	UNSIGNED16
Access	ro
Object	2081h
Sub-index	00h

Display

Menu	Er 1/"n" (DIAGN \ Error \ Er 1/"n")
------	-------------------------------------

Data type UNSIGNED16

Value range	0 ... 65535
Default	0 (default)

4.7.3 Error Number 2

General characteristics

EEPROM	yes
Class	E
Unit	-

POWERLINK

Data type	UNSIGNED16
Access	ro
Object	2082h
Sub-index	00h

Display

Menu	Er2/"n" (DIAGN \ Error \ Er2/"n")
------	-----------------------------------

Data type UNSIGNED16

Value range	0 ... 65535
Default	0 (default)

4.7.4 Error Number 3

General characteristics

EEPROM	yes
Class	E
Unit	-

POWERLINK

Data type	UNSIGNED16
Access	ro
Object	2083h
Sub-index	00h

Display

Menu	Er3/"n" (DIAGN \ Error \ Er3/"n")
------	-----------------------------------

Data type UNSIGNED16

Value range	0 ... 65535
Default	0 (default)

4.7.5 Error Number 4

General characteristics

EEPROM	yes
Class	E
Unit	-

POWERLINK

Data type	UNSIGNED16
Access	ro
Object	2084h
Sub-index	00h

Display

Menu	Er4/"n" (DIAGN \ Error \ Er4/"n")
------	-----------------------------------

Data type UNSIGNED16

Value range	0 ... 65535
Default	0 (default)

4.7.6 Error Number 5

General characteristics

EEPROM	yes
Class	E
Unit	-

POWERLINK

Data type	UNSIGNED16
Access	ro
Object	2085h
Sub-index	00h

Display

Menu	Er5/"n" (DIAGN \ Error \ Er5/"n")
------	-----------------------------------

Data type UNSIGNED16

Value range	0 ... 65535
Default	0 (default)

4.7.7 Error Number 6

General characteristics

EEPROM	yes
Class	E
Unit	-

POWERLINK

Data type	UNSIGNED16
Access	ro
Object	2086h
Sub-index	00h

Display

Menu	Er6/"n" (DIAGN \ Error \ Er6/"n")
------	-----------------------------------

Data type UNSIGNED16

Value range	0 ... 65535
Default	0 (default)

4.7.8 Error Number 7

General characteristics

EEPROM	yes
Class	E
Unit	-

POWERLINK

Data type	UNSIGNED16
Access	ro
Object	2087h
Sub-index	00h

Display

Menu	Er7/"n" (DIAGN \ Error \ Er7/"n")
------	-----------------------------------

Data type UNSIGNED16

Value range	0 ... 65535
Default	0 (default)

4.7.9 Error Number 8

General characteristics

EEPROM	yes
Class	E
Unit	-

POWERLINK

Data type	UNSIGNED16
Access	ro
Object	2088h
Sub-index	00h

Display

Menu	Er8/"n" (DIAGN \ Error \ Er8/"n")
------	-----------------------------------

Data type UNSIGNED16

Value range	0 ... 65535
Default	0 (default)

4.7.10 Error Number 9

General characteristics

EEPROM	yes
Class	E
Unit	-

POWERLINK

Data type	UNSIGNED16
Access	ro
Object	2089h
Sub-index	00h

Display

Menu	Er9/"n" (DIAGN \ Error \ Er9/"n")
------	-----------------------------------

Data type UNSIGNED16

Value range	0 ... 65535
Default	0 (default)

4.7.11 Error Number 10

General characteristics

EEPROM	yes
Class	E
Unit	-

POWERLINK

Data type	UNSIGNED16
Access	ro
Object	208Ah
Sub-index	00h

Display

Menu	Er 10/"n" (DIAGN \ Error \ Er 10/"n")
------	---------------------------------------

Data type UNSIGNED16

Value range	0 ... 65535
Default	0 (default)

4.7.12 Error Status

The current error status is output (see chapter [3.5.2.1](#)).

General characteristics

EEPROM	no
Class	PD
Unit	-

POWERLINK

Data type	INTEGER16
Access	ro
Object	2008h
Sub-index	00h

Display

Menu	
------	--

Data type INTEGER16

Value range	-32768 ... 32767
Default	0 (default)

5 Ethernet POWERLINK®

5.1 Description

The position indicator is an Ethernet POWERLINK Controlled Node (CN). The Ethernet POWERLINK communication profile is based on the DS301 and DS302 CANopen communication profiles.

5.1.1 IP Configuration

NOTICE

The node number can be reset to the factory setting by a System-Command (see chapter 4.5.21).
The Explicit Device ID is assigned to the parameter class N.

The node number is set via the display menu `cHPARA \ SETEPL \ SET`. The permissible range of the node number for the actuator is 1 ... 239.

The factory setting of the node number is 124.

The node number is in the `cHPARA \ SETEPL` display menu:

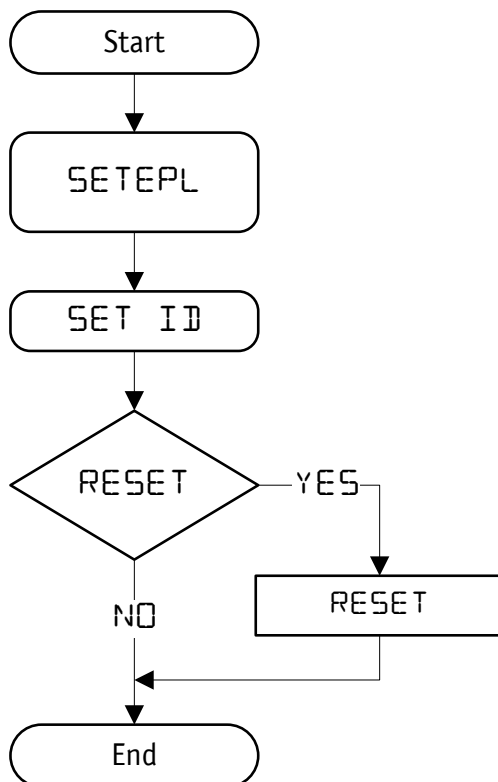

Fig. 7: Setting of the IP address

5.1.2 Cyclic data exchange

Cyclic process data is exchanged via PDO. The position indicator supports 1 TPDO and 1 RPDO. Mapping is static and cannot be changed.

5.1.3 Acyclic data exchange

Acyclic data is exchanged via SDO frames.

5.1.4 Operating modes and synchronization

The position indicator is not synchronized.

5.2 Directory of objects

5.2.1 Parameter description of standard objects

5.2.1.1 1000h: NMT_DeviceType_U32

Sub-index	00h
Description	Device profile
Access	const
PDO mapping	no
Data type	UNSIGNED32
Default	0000 0000h (no profile)

5.2.1.2 1001h: ERR_ErrorRegister_U8

Sub-index	00h
Description	Error register
Access	ro
PDO mapping	no
Data type	UNSIGNED8
Default	00h

5.2.1.3 1006h: NMT_CycleLen_U32

Sub-index	00h
Description	Cycle time in μ s
Access	rw, valid on reset
PDO mapping	no
Data type	UNSIGNED32
Default	200
Value range	200 ... 2147483

5.2.1.4 1008h: NMT_ManufactDevName_VS

Sub-index	00h
Description	Device name
Access	const
PDO mapping	no
Data type	VISIBLE_STRING64
Default	"SIKO Positionline AP20 EPL"

5.2.1.5 1009h: NMT_ManufactHwVers_VS

Sub-index	00h
Description	Hardware version
Access	const
PDO mapping	no
Data type	VISIBLE_STRING64
Default	"HW_02.00"

5.2.1.6 100Ah: NMT_ManufactSwVers_VS

Sub-index	00h
Description	Software version
Access	const
PDO mapping	no
Data type	VISIBLE_STRING64
Default	"SW_01.01"

5.2.1.7 1018h: Identity Object

Sub-index	00h
Description	Number of entries
Access	const
PDO mapping	no
Data type	UNSIGNED8
Default	04h

Sub-index	01h
Description	Vendor ID
Access	const
PDO mapping	no
Data type	UNSIGNED32
Default	0000 0195h

Sub-index	02h
Description	Product code
Access	const
PDO mapping	no
Data type	UNSIGNED32
Default	0000 0102h

Sub-index	03h
Description	Revision number
Access	const
PDO mapping	no
Data type	UNSIGNED32
Default	Current revision number

Sub-index	04h
Description	Serial number
Access	const
PDO mapping	no
Data type	UNSIGNED32
Default	Serial number of the device

5.2.1.8 1020h: CFM_VerifyConfiguration_REC

Sub-index	00h
Description	Number of entries
Access	const
PDO mapping	no
Data type	UNSIGNED8
Default	02h

Sub-index	01h
Description	Date of configuration
Access	rw, valid on reset
PDO mapping	no
Data type	UNSIGNED32
Default	0
Value range	0 ... FFFF FFFFh

Sub-index	02h
Description	Time of configuration
Access	rw, valid on reset
PDO mapping	no
Data type	UNSIGNED32
Default	0
Value range	0 ... FFFF FFFFh

5.2.1.9 1021h: CFM_StoreDevDescrFile_DOM

Sub-index	00h
Description	Content of an XDD file
Access	ro
PDO mapping	no
Data type	DOMAIN
Default	no XDD file existing

5.2.1.10 1022h: CFM_StoreDevDescrFormat_U16

Sub-index	00h
Description	Description of the content of object 1021h.
Access	ro
PDO mapping	no
Data type	UNSIGNED16
Default	FFh: Object 1021h contains no XDD file.

5.2.1.11 1030h: NMT_InterfaceGroup_00h_REC

Sub-index	00h
Description	Number of entries
Access	const
PDO mapping	no
Data type	UNSIGNED8
Default	09h

Sub-index	01h
Description	InterfaceIndex_U16: Interface Index
Access	ro
PDO mapping	no
Data type	UNSIGNED16
Default	0001h

Sub-index	02h
Description	InterfaceDescription_VSTR: InterfaceDescription
Access	const
PDO mapping	no
Data type	VISIBLE_STRING194
Default	"SIKO Positionline AP20 EPL "

Sub-index	03h
Description	InterfaceType_U8: InterfaceType
Access	const
PDO mapping	no
Data type	UNSIGNED8
Default	06h

Sub-index	04h
Description	InterfaceMtu_U16: Interface maximum transmission unit
Access	const
PDO mapping	no
Data type	UNSIGNED16
Default	1500 Bytes

Sub-index	05h
Description	InterfacePhysAddress_OSTR: Interface Physical Address
Access	const
PDO mapping	no
Data type	OCTET_STRING6
Default	MAC address

Sub-index	06h
Description	InterfaceName_VSTR: Interface Name
Access	ro
PDO mapping	no
Data type	VISIBLE_STRING11
Default	"Interface 1"

Sub-index	07h
Description	InterfaceOperStatus_U8: Interface Operational Status
Access	ro
PDO mapping	no
Data type	UNSIGNED8
Default	01h

Sub-index	08h
Description	InterfaceAdminState_U8: Interface Admin State
Access	rw
PDO mapping	no
Data type	UNSIGNED8
Default	01h

Sub-index	09h
Description	Valid_Bool: Valid
Access	rw
PDO mapping	no
Data type	BOOLEAN
Default	01h

5.2.1.12 1300h: SDO_SequLayerTimeout_U32

Sub-index	00h
Description	Timeout for detection of disconnection of the SDO sequence
Access	rw, valid on reset
PDO mapping	no
Data type	UNSIGNED32
Default	15000
Value range	100 ... FFFFFFFFh

5.2.1.13 1400h: PDO_RxCommParam_00h_REC

Sub-index	00h
Description	Number of entries
Access	const
PDO mapping	no
Data type	UNSIGNED8
Default	02h

Sub-index	01h
Description	NodeID_U8: Node ID
Access	rw
PDO mapping	no
Data type	UNSIGNED8
Default	00h

Sub-index	02h
Description	MappingVersion_U8: Mapping version
Access	ro
PDO mapping	no
Data type	UNSIGNED8
Default	00h

5.2.1.14 1600h: PDO_RxMappParam_00h_AU64

Sub-index	00h
Description	Number of entries
Access	ro
PDO mapping	no
Data type	UNSIGNED8
Default	03h

Sub-index	01h
Description	Mapped Object 001
Access	ro
PDO mapping	no
Data type	UNSIGNED64
Default	0020 0000 0000 2003h

Sub-index	02h
Description	Mapped Object 002
Access	ro
PDO mapping	no
Data type	UNSIGNED64
Default	0010 0020 0000 2002h

Sub-index	03h
Description	Mapped Object 003
Access	ro
PDO mapping	no
Data type	UNSIGNED64
Default	0010 0030 0000 2001h

5.2.1.15 1800h: PDO_TxCommParam_00h_REC

Sub-index	00h
Description	Number of entries
Access	const
PDO mapping	no
Data type	UNSIGNED8
Default	02h

Sub-index	01h
Description	NodeID_U8: Node ID
Access	rw
PDO mapping	no
Data type	UNSIGNED8
Default	00h

Sub-index	02h
Description	MappingVersion_U8: Mapping version
Access	ro
PDO mapping	no
Data type	UNSIGNED8
Default	00h

5.2.1.16 1A00h: PDO_TxMappParam_00h_AU64

Sub-index	00h
Description	Number of entries
Access	rw
PDO mapping	no
Data type	UNSIGNED8
Default	04h

Sub-index	01h
Description	Mapped Object 001
Access	ro
PDO mapping	no
Data type	UNSIGNED64
Default	0020 0000 0000 2103h

Sub-index	02h
Description	Mapped Object 002
Access	ro
PDO mapping	no
Data type	UNSIGNED64
Default	0020 0020 0000 2104h

Sub-index	03h
Description	Mapped Object 003
Access	ro
PDO mapping	no
Data type	UNSIGNED64
Default	0010 0040 0000 2102h

Sub-index	04h
Description	Mapped Object 004
Access	ro
PDO mapping	no
Data type	UNSIGNED64
Default	0010 0050 0000 2101h

5.2.1.17 1COBh: DLL_CNLossSoC_REC

Sub-index	00h
Description	Number of entries
Access	const
PDO mapping	no
Data type	UNSIGNED8
Default	03h

Sub-index	01h
Description	CumulativeCnt_U32: Cumulative count
Access	rw
PDO mapping	no
Data type	UNSIGNED32
Default	0
Value range	0 ... FFFFFFFFh

Sub-index	02h
Description	ThresholdCnt_U32: Threshold count
Access	ro
PDO mapping	no
Data type	UNSIGNED32
Default	0

Sub-index	03h
Description	Threshold_U32: Threshold
Access	rw
PDO mapping	no
Data type	UNSIGNED32
Default	Fh
Value range	0 ... FFFFFFFFh

5.2.1.18 1C0Fh: DLL_CNCRCErrror_REC

Sub-index	00h
Description	Number of entries
Access	const
PDO mapping	no
Data type	UNSIGNED8
Default	03h

Sub-index	01h
Description	CumulativeCnt_U32: Cumulative count
Access	rw
PDO mapping	no
Data type	UNSIGNED32
Default	0
Value range	0 ... FFFFFFFFh

Sub-index	02h
Description	ThresholdCnt_U32: Threshold count
Access	ro
PDO mapping	no
Data type	UNSIGNED32
Default	0

Sub-index	03h
Description	Threshold_U32: Threshold
Access	rw
PDO mapping	no
Data type	UNSIGNED32
Default	Fh
Value range	0 ... FFFFFFFFh

5.2.1.19 1C14h: DLL_CNLossOfSocTolerance_U32

Sub-index	00h
Description	Tolerance interval in [ns] to be applied for the CNs Loss of SoC error detection.
Access	rw
PDO mapping	no
Data type	UNSIGNED32
Default	100000
Value range	0 ... 2147483000

5.2.1.20 1F50h: PDL_DownloadProgData_AD0M

Sub-index	00h
Description	Number of entries
Access	ro
PDO mapping	no
Data type	UNSIGNED8
Default	01h

Sub-index	01h
Description	A HIFF file for updating the module firmware
Access	wo
PDO mapping	no
Data type	DOMAIN

5.2.1.21 1F51h: PDL_ProgCtrl_AU8

Sub-index	00h
Description	Number of entries
Access	ro
PDO mapping	no
Data type	UNSIGNED8
Default	01h

Sub-index	01h
Description	ProgCtrl: Program control
Access	rw
PDO mapping	no
Data type	UNSIGNED8
Default	01h Writing a value other than 1 results in an SDO abort message (error code 08000024h)

5.2.1.22 1F52h: PDL_LocVerApplSw_REC

Sub-index	00h
Description	Number of entries
Access	const
PDO mapping	no
Data type	UNSIGNED8
Default	02h

Sub-index	01h
Description	ApplSwDate_U32: Number of dates between 1984-01-01 and the time of software creation
Access	ro
PDO mapping	no
Data type	UNSIGNED32

Sub-index	02h
Description	ApplSwTime_U32: Milliseconds since midnight at the time of software reation
Access	ro
PDO mapping	no
Data type	UNSIGNED32

5.2.1.23 1F81h: NMT_NodeAssignment_AU32

Sub-index	00h
Description	Number of entries
Access	rw, valid on reset
PDO mapping	no
Data type	UNSIGNED8
Default	FEh
Value range	01h ... FEh

Sub-index	01h ... FEh
Description	NodeAssignment
Access	rw, valid on reset
PDO mapping	no
Data type	UNSIGNED32
Default	0

5.2.1.24 1F82h: NMT_FeatureFlags_U32

Sub-index	00h
Description	Feature Flags
Access	const
PDO mapping	no
Data type	UNSIGNED32
Default	48205h

5.2.1.25 1F83h: NMT_EPLVersion_U8

Sub-index	00h
Description	Ethernet POWERLINK Version
Access	const
PDO mapping	no
Data type	UNSIGNED8
Default	20h

5.2.1.26 1F8Ch: NMT_CurrNMTState_U8

Sub-index	00h
Description	Current NMT state
Access	ro
PDO mapping	no
Data type	UNSIGNED8

5.2.1.27 1F8Dh: NMT_PresPayloadLimitList_AU16

Sub-index	00h
Description	Number of entries
Access	rw, valid on reset
PDO mapping	no
Data type	UNSIGNED8
Default	FEh
Value range	01h ... FEh

Sub-index	01h ... FEh
Description	PresPayloadLimit
Access	rw, valid on reset
PDO mapping	no
Data type	UNSIGNED16
Default	36
Value range	0, 36 ... 1490, FFFFh

5.2.1.28 1F93h: NMT_EPLNodeID_REC

Sub-index	00h
Description	Number of entries
Access	const
PDO mapping	no
Data type	UNSIGNED8
Default	02h

Sub-index	01h
Description	NodeID_U8: NodeID
Access	ro
PDO mapping	no
Data type	UNSIGNED8
Default	Set NodeID

Sub-index	02h
Description	NodeIDByHW_BOOL: NodeID by hardware
Access	ro
PDO mapping	no
Data type	BOOLEAN
Default	01h

5.2.1.29 1F98h: NMT_CycleTiming_REC

Sub-index	00h
Description	Number of entries
Access	const
PDO mapping	no
Data type	UNSIGNED8
Default	08h

Sub-index	01h
Description	IsochrTxMaxPayload_U16
Access	const
PDO mapping	no
Data type	UNSIGNED16
Default	1490

Sub-index	02h
Description	IsochrRxMaxPayload_U16
Access	const
PDO mapping	no
Data type	UNSIGNED16
Default	1490

Sub-index	03h
Description	PresMaxLatency_U32
Access	const
PDO mapping	no
Data type	UNSIGNED32
Default	1000

Sub-index	04h
Description	PReqActPayloadLimit_U16
Access	rw, valid on reset
PDO mapping	no
Data type	UNSIGNED16
Default	36

Sub-index	05h
Description	PresActPayloadLimit_U16
Access	rw, valid on reset
PDO mapping	no
Data type	UNSIGNED16
Default	36

Sub-index	06h
Description	AsndMaxLatency_U32
Access	const
PDO mapping	no
Data type	UNSIGNED32
Default	1000

Sub-index	07h
Description	MultiplCycleCnt_U8
Access	rw, valid on reset
PDO mapping	no
Data type	UNSIGNED8
Default	0
Value range	0 ... 255

Sub-index	08h
Description	AsyncMTU_U16
Access	rw, valid on reset
PDO mapping	no
Data type	UNSIGNED16
Default	300
Value range	300 ... 1500

5.2.1.30 1F99h: NMT_CNBasicEthernetTimeout_U32

Sub-index	00h
Description	After booting, this is the maximum time in microseconds the module listens in mutely on the POWERLINK traffic before it decides whether it will switch over to the Basic Ethernet state (no EPL traffic) or Pre-Operational 1 state (with EPL traffic).
Access	rw, valid on reset
PDO mapping	no
Data type	UNSIGNED32
Default	5000000

5.2.1.31 1F9Bh: NMT_MultiplCycleAssign_AU8

Sub-index	00h
Description	Number of entries
Access	rw, valid on reset
PDO mapping	no
Data type	UNSIGNED8
Default	FEh
Value range	01h ... FEh

Sub-index	01h ... FEh
Description	Cycle number
Access	rw, valid on reset
PDO mapping	no
Data type	UNSIGNED8
Default	0
Value range	0 ... NMT_CylceTiming_REC.MultiplCycleCnt_U8 (the value of object 1F98h sub-index 7).

5.2.1.32 1F9Eh: NMT_ResetCmd_U8

Sub-index	00h
Description	Reset command
Access	rw
PDO mapping	no
Data type	UNSIGNED8
Default	FFh

5.2.2 Parameter description of manufacturer-specific objects

See chapter 4.

5.3 Commissioning aids

Service software, functional module or example projects including step-by-step instructions are available as commissioning aids.

6 Block diagram

Fig. 8: Block diagram



SIKO GmbH

Weihermattenweg 2
79256 Buchenbach

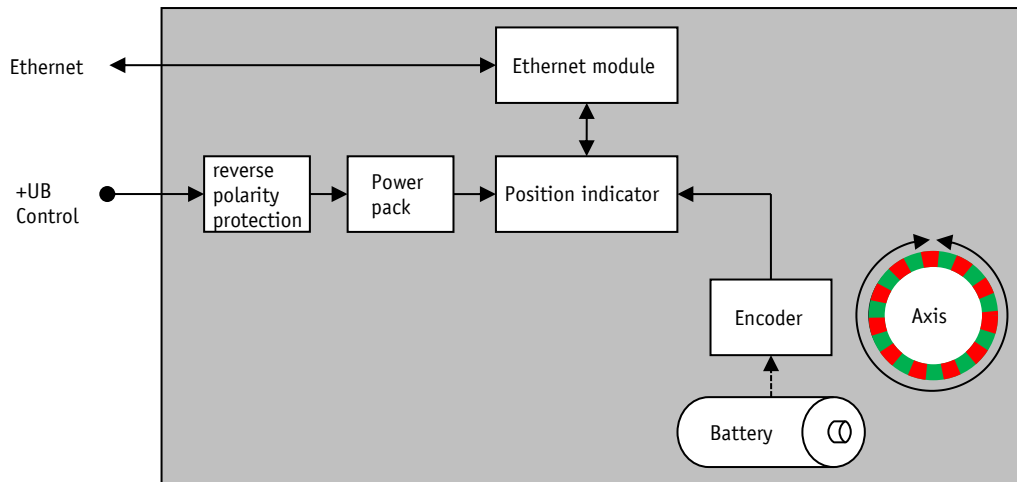
Phone

+ 49 7661 394-0

Fax

+ 49 7661 394-388

E-Mail

info@siko-global.com

Internet

www.siko-global.com

Service

support@siko-global.com