

AP05

Absolute Position Indicator with  IO-Link interface

User manual



Table of contents

1	General Information	5
1.1	Documentation	5
1.1.1	History	5
1.2	Definitions	5
1.3	Intended use	5
1.4	Switching on the operating voltage.....	6
2	Display and control elements.....	6
2.1	LCD display.....	6
2.1.1	Extended display range	7
2.2	LED display.....	7
2.2.1	Device status.....	7
2.2.2	Communication state.....	7
2.3	Control keys.....	8
2.3.1	Key lock and enable time	8
3	Functional Description	8
3.1	Operating modes	8
3.1.1	Absolute position operating mode	8
3.1.1.1	Positioning.....	8
3.1.1.2	Loop positioning	10
3.1.1.3	ControlWord in Absolute Position operating mode	10
3.1.1.4	StatusWord in Absolute Position operating mode	11
3.1.2	Alpha-numeric display operating mode.....	12
3.1.2.1	ControlWord: Alpha-numeric display	13
3.1.2.2	StatusWord: Alpha-numeric display	13
3.2	Battery buffering.....	14
3.3	Parameterization of the position indicator	14
3.3.1	Manual parameterization.....	15
3.3.1.1	Starting parameterization	15
3.3.1.2	Value input.....	15
3.3.1.3	Value selection.....	15
3.3.1.4	Overview of the operating menu	16
3.3.1.5	"Changeable parameters" menu	17
3.3.1.6	Positioning.....	17
3.3.1.7	Visualization.....	17
3.3.1.8	LED function.....	18
3.3.1.9	Device options	18
3.3.2	Parameterization via interface	18
3.4	Calibration	18
3.5	Additional functions	19
3.5.1	Device information.....	19
3.5.2	Diagnosis.....	19

3.5.2.1	Reading the error memories	19
3.5.2.2	Presentation	20
3.5.3	Restore factory settings	20
3.5.4	Operation hours counter	20
3.5.4.1	General operating hours counter	20
3.5.4.2	Customer-specific operating hours counter	21
3.6	Warnings / Errors.....	21
3.6.1	Warnings	21
3.6.2	Errors	22
3.6.2.1	Error memory	22
3.6.2.2	Error counter	23
3.6.3	Corrective actions	23
3.7	Adjustment run (already carried out at the factory for AP05)	23
4	Parameter	24
4.1	Process data	24
4.1.1	ControlWord	24
4.1.2	StatusWord	24
4.1.3	TargetValue	25
4.1.4	ActualValue	25
4.1.5	DisplayData	26
4.1.6	TargetValueLeft.....	26
4.2	Positioning.....	26
4.2.1	Resolution	26
4.2.2	DecimalPlaces.....	27
4.2.3	DisplayDivisor.....	28
4.2.4	CountingDirection	28
4.2.5	CalibrationValue.....	29
4.2.6	TargetWindow.....	29
4.2.7	LoopType	30
4.2.8	LoopLength.....	30
4.3	Visualization.....	31
4.3.1	DisplayOrientation	31
4.4	LEDs	31
4.4.1	LEDMode.....	31
4.4.2	Led1GreenMode	32
4.4.3	Led2GreenMode	32
4.4.4	Led1RedMode	33
4.4.5	Led2RedMode	33
4.4.6	ActiveLedsFlashing	34
4.5	Device options	34
4.5.1	KeyEnableTime.....	34
4.5.2	KeyCalibration	35
4.5.3	KeyIncremental.....	35

4.5.4	OperatingMode	36
4.5.5	PinChange.....	36
4.5.6	LoadDefault.....	37
4.5.7	CODE.....	37
4.6	Error counter	37
4.6.1	Event counter for the error "Battery dead".....	38
4.6.2	Event counter for the error "Permissible travel speed exceeded"	38
4.6.3	Event counter for the error "Sensor error, magnetic field faulty"	39
4.6.4	Event counter for the error "Sensor error, reader head faulty".....	39
4.6.5	Event counter for the error "Sensor error, SIN COS Monitoring"	39
4.6.6	Event counter for the error "Sensor error, internal error3".....	40
4.6.7	Event counter for the error "Sensor error, internal error4"	40
5	IO-Link	41
5.1	Process data input / output	41
5.1.1	Process data in Absolute position operating mode	42
5.1.1.1	Process data output (master ⇒ device)	42
5.1.1.2	Process data input (device ⇒ master).....	43
5.1.2	Process data in Alphanumeric display operating mode	44
5.1.2.1	Process data output (master ⇒ device)	44
5.1.2.2	Process data input (device ⇒ master).....	45
5.2	Directory of objects	46
5.2.1	IO-Link specific objects.....	46
5.3	SystemCommands	47
5.4	DeviceAccessLocks	47
5.5	EventCodes.....	47
5.6	ErrorCodes	48
6	Block diagram	49

1 General Information

1.1 Documentation

The following documents are associated with this document:

- The data sheet describes the technical data, the dimensions, the pin assignment, the accessories and the order key.
- The installation instructions describe the mechanical and electrical installation with all safety-relevant conditions and the associated technical specifications.
- User manual for connecting the display to an IO-Link master and for commissioning.
- IODD file (IO-Link Device Description); with the help of this file, the connection and configuration with an IO-Link master is possible by means of commercially available IO-Link masters and their configurators.

You can also download these documents at <http://www.siko-global.com/p/ap05>.

1.1.1 History

Mod. status	Date	Description
108/22	22.08.2022	Document prepared

1.2 Definitions

If not explicitly stated otherwise, decimal values are given as figures without an extension (e. g., 1234), binary values are marked after the figure with a "b" (e. g., 1011b), hexadecimal values with an "h" (e. g., 280h).

1.3 Intended use

Unless otherwise described normal operation of the system with unchanged factory setting is assumed for the further description of functions.

The present device is an absolute position indicator with integrated IO-Link interface and a hollow shaft for direct shaft mounting. Indicators, control buttons and interface are only active with external power supply. The sensor of measurement encoder works magnetically incrementally. Without an external power supply, encoder changes are recorded with battery support. The status of the replaceable battery is monitored. A volatile TargetValue can be displayed below the ActualValue via the backlit two-line LC display A direction display (indicator) is displayed if there is a deviation between the actual value and the target window (target value including TargetWindow parameter). The arrow direction indicates in which direction the shaft must be rotated to reach the target window. In addition, different visualization tasks can be realized with the help of two two-color LEDs (green and red). Device malfunctions or inadmissible operating conditions are displayed.

The 3 buttons can be used to select various functions and to adapt the device parameters of the application stored in non-volatile memory. The actual value can be queried via the interface, the target value can be changed and all device parameters can be adjusted.

1.4 Switching on the operating voltage

The AP05 will be initialized after switching on the supply voltage. A system and display test is executed during initialization, the LEDs are lighted consecutively and the parameters are loaded from the non-volatile memory into the RAM of the controller.

At first use, the default values are used during initialization. After the return of the external power supply or software reset (warm start), the AP05 works with the last saved parameters. If no fault has been detected, the AP05 starts normal operation and can communicate with an IO-Link Master.

2 Display and control elements

The position indicator has a two-line display with special characters and three control keys.

The actuator can be configured and controlled via the keys.

Two device status LEDs (LED1, LED2) serve for monitoring positioning.

A COM LED (COM LED) indicates the status of the IO-Link communication.

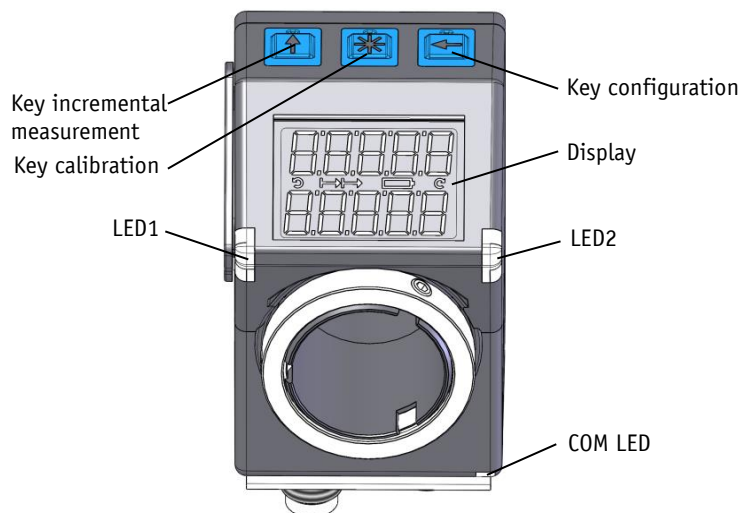



Fig. 1: Display and control elements

2.1 LCD display

NOTICE	The display range is limited to -199999 ... 999999. Values outside this range are displayed with "FULL".
---------------	--

When the operating voltage is applied, the actual value (absolute position value, ActualValue) is displayed in the first line. If there is no valid target value " --- ". appears in the second line. If a target value is declared valid by means of the control bit in the process data (see e. g., [bc09_TargetValueActive](#)), this is displayed in the 2nd line. The values displayed are determined by the operating mode.

Direction indicators (arrows) support positioning.

The battery symbol  is shown with a critical or insufficient battery status. If battery voltage drops to a critical value, the battery symbol on the display will flash. If it falls below the minimum value, the symbol will glow permanently.

With incremental measurement function activated, the incremental measurement symbol  is shown.

This is signaled in red letters in the event of a fault.

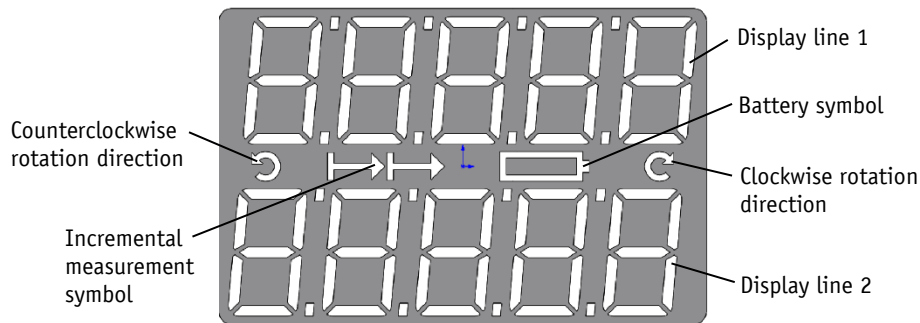

Fig. 2: Two-line 7 segment LCD display

2.1.1 Extended display range

Values up to -199999 can be displayed by means of the ControlWords (see [bc03_DisplayRange](#)). If the relevant bit has been set and the value to be displayed is between -199999 and -999999, then the negative sign and the digit of the highest order will flash alternately. If the value range drops below -999999, "FULL" will be displayed.

2.2 LED display

2.2.1 Device status

NOTICE	A test sequence is executed on these LEDs during initialization.
---------------	--

In its basic state (factory setting) the LED display has different meanings depending on the operating mode (see chapter [3.1](#)).

In order for LED1 or LED2 to be controlled via the ControlWord, this function of the LEDs must be activated by means of parameters (see chapter [3.1.1.3](#), [3.1.2.1](#), [4.4](#) and [5.1](#)).

2.2.2 Communication state

COM LED state	Description
green	Operating voltage OK
green, blinks 90:10	Operating voltage OK IO-Link SDCI communication active
off	Operating voltage too low

Table 1: COM LED state

2.3 Control keys

Pressing  the Incremental button switches the increment function or a relative measurement on or off.

Pressing  the Calibration button starts the calibration (see chapter 3.4) and acknowledges an existing fault (see chapter 3.6).

In the "Alphanumeric display" operating mode, the receipt of a target value is acknowledged by this action.

Pressing  the Configuration button starts the parameterization.

See also chapter 3.3.1 and Fig. 1.

2.3.1 Key lock and enable time

The key access to the chain dimension function and calibration can be generally blocked with the parameters KeyCalibration and KeyIncremental (see chapter 4.5.2). The time during which the button  must be pressed until you can enter the menu can be set in the Device options menu. Access via keys to the changeable device parameters can only be obtained after entering the PIN. This can be defined using the parameter PinChange (see chapter 4.5.5).

3 Functional Description

3.1 Operating modes

The following position-dependent operating modes are differentiated: **Absolute position** and the position-independent operating mode **Alpha-numeric display**.

Operating mode	Absolute position	Absolute position
Line 1	Actual value (ActualValue)	Target value 1 (DisplayData)
Line 2	Target value (TargetValue)	Target value 2 (TargetValue)

Table 2: Display with different operating modes

3.1.1 Absolute position operating mode

The measured absolute position value is calculated depending on the parameters Resolution, DisplayDivisor and DecimalPlaces and displayed as actual value. The actual value (ActualValue) of higher-level control can be provided via the interface and a target value can be set as a default. The target value must be set to valid in the ControlWord (bc09_TargetValueActive).

3.1.1.1 Positioning

Target window:

A target window is formed to be able to define a tolerance range.

Target window = $\text{TargetValue} \pm \text{TargetWindow}$

Example Position monitoring:

TargetWindow = 5
 TargetValue = 100

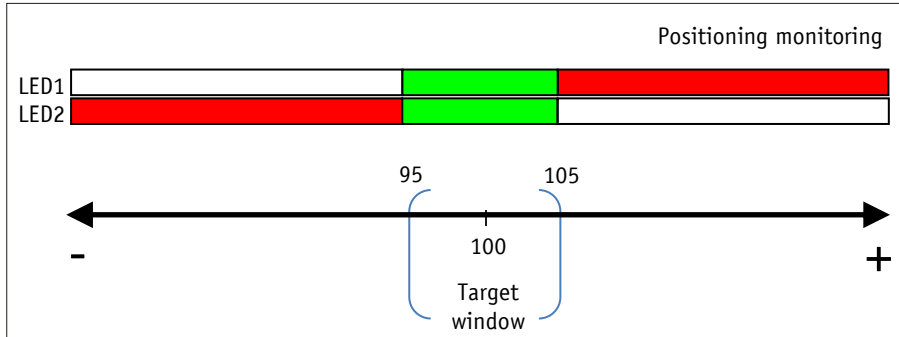

Fig. 3: Positioning monitoring with TargetWindow

Directional arrows:

To assist in positioning, direction arrows are displayed in the display as long as the current actual value is outside the valid target window. The arrow direction indicates in which direction the shaft must be moved to reach the target window.

LED display:

With factory setting, the LED glows green as long as the actual value is within the programmed window. When leaving target window, the LED glows red. The shaft must be rotated in the direction of the glowing LED in order to arrive at the target value. The red glowing LED1 (left): counter-clockwise (ccw) rotation required. Red glowing LED2 (right): clockwise (cw) rotation required.

With factory settings, the LED display (see chapter 4.4) has the following meaning:

Operating state	LED	Meaning
There is no valid target value or no operating voltage.	Both LEDs inactive	No position monitoring active.
There is a valid target value.	Both LEDs green	The actual value is within the programmed target window.
	LED1 red	The actual value is outside the programmed target window. The axis must be rotated counterclockwise to reach the target window.
	LED2 red	The actual value is outside the programmed target window. The axis must be rotated clockwise to reach the target window.

Table 3: LED display

3.1.1.2 Loop positioning

NOTICE Target window is also applied to the loop length.

NOTICE The behavior of the clearance compensation is independent of the set counting direction of the display. The loop type must be changed to change the clearance compensation.

If the position indicator is operated on a spindle or an additional gear, the spindle or external gear backlash can be compensated by means of loop positioning. Therefore, movement towards the target value is always in the same direction. This direction of approach can be defined.

Example:

Each target position should be approached with a clockwise rotation (CW) of the shaft.

- Case 1 ⇒ the new position is greater than actual value:
The target position is approached directly clockwise (CW).
- Case 2 ⇒ the new position is smaller than actual value:
The directional arrows of the position indicator indicate that the loop length is to be moved counterclockwise (CCW) beyond the target position. Then the target value is approached clockwise.

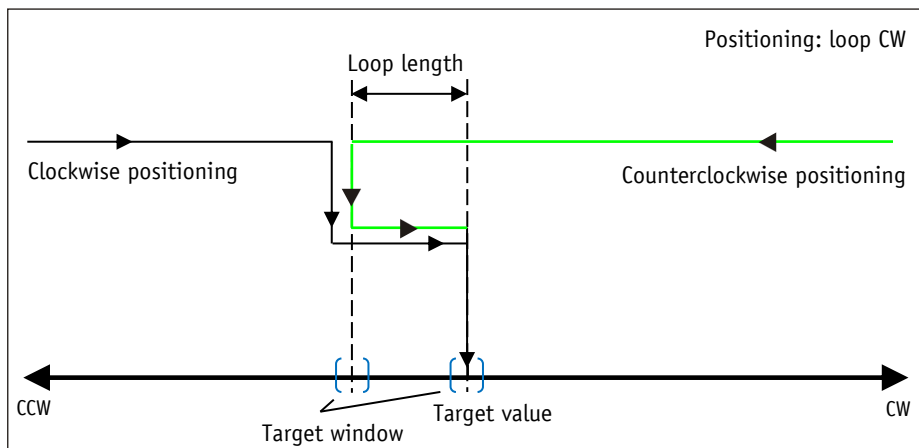

Fig. 4: Positioning loop CW

3.1.1.3 ControlWord in Absolute Position operating mode

The ControlWord differs in function depending on operating mode.

The designation of the individual bits of the ControlWord as well as their meaning:

Bit	Meaning	Value = 0	Value = 1
0	bc00_CalibrationExecute	-	Trigger calibration (edge controlled, positive)
1	bc01_Reserved	ever 0	-
2	bc02_Reserved	ever 0	-

Bit	Meaning		Value = 0	Value = 1
3	bc03_DisplayRange		Normal display area	Extended display area
4	bc04_GuardingBit		is mirrored in StatusWord	is mirrored in StatusWord
5	bc05_ErrorAck		-	Acknowledge error
6	bc06_Reserved		ever 0	-
7	bc07_Reserved		ever 0	-
8	bc08_Reserved		ever 0	-
9	bc09_TargetValueActive		-	Activate target value
10	bc10_Reserved		ever 0	-
11	bc11_Led1Green	Release via LED parameters required	Deactivate LED	Activate LED
12	bc12_Led1Red		Deactivate LED	Activate LED
13	bc13_Led2Green		Deactivate LED	Activate LED
14	bc14_Led2Red		Deactivate LED	Activate LED
15	bc15_LedBlinking		Deactivate LED	Activate LED

Table 4: ControlWord in Absolute Position operating mode

3.1.1.4 StatusWord in Absolute Position operating mode

The Status Word shows the current status of the AP05.

The designation of the individual bits of the StatusWord as well as their meaning:

Bit	Meaning	Value= 0	Value= 1
0	bs00_DirIndicationCW	Target value can be reached counterclockwise or in negative direction	Target value can be reached clockwise or in positive direction
1	bs01_DirIndicationCCW	Target value can be reached clockwise or in positive direction	Target value can be reached counterclockwise or in negative direction
2	bs02_CalibrationExecuted	No calibration is currently being carried out	A calibration is currently being carried out
3	bs03_Reserved	ever0	-
4	bs04_GuardingBit	mirrored from ControlWord	mirrored from ControlWord
5	bs05_TargetWindowReached	Target window is not reached	Target window is reached
6	bs06_Deviation	Deviation Actual value \leq target value	Deviation Actual value $>$ target value
7	bs07_GeneralError	No error	There is an error
8	bs08_Reserved	ever0	-
9	bs09_IncMeasurement	Increment measurement is deactivated	Increment measurement is activated
10	bs10_TargetValueState	Target value is not activated	Target value is activated

Bit	Meaning	Value= 0	Value= 1
11	bs11_BatteryState	Battery Charging state is OK	Battery Charging state is critical
12	bs12_SpeedError	There is no SpeedError	There is a SpeedError
13	bs13_KeyConfiguration	Button is not pressed	Button is pressed
14	bs14_KeyCalibration	Button is not pressed	Button is pressed
15	bs15_KeyIncremental	Button is not pressed	Button is pressed

Table 5: StatusWord in Absolute Position operating mode

3.1.2 Alpha-numeric display operating mode

Two 5-digit target values can be displayed in this operating mode. The target values are acknowledged by pressing the  button (see chapter 2.3).

Alpha-numeric display:

Both lines are freely writable. The content of the display line can be transmitted via the [DisplayData](#) parameter, and the content of the display line can be transmitted via the [TargetValue](#) parameter. In [ControlWord](#), the values must be switched to valid (see e. g., [bc09_TargetValueActive](#)) and the bits for data identification must be set correctly (see e. g., [bc07_TargetValueTypeSelect](#)). The data identifier is used to distinguish whether the data is interpreted and displayed as a number or as an alphanumeric character (ASCII) (see chapter 4.1.1, 4.1.3 and 4.1.5).

LCD display:

If there is no valid target value, the 1st display line is displayed blank. "---" appears in the 2nd display line.

A valid target value is displayed flashing until its receipt is acknowledged. If neither target value has been acknowledged, both values are acknowledged jointly by pressing the  key. Acknowledgment can also take place via the corresponding control bit via the interface.

LED display:

Status LED1 and LED2:

With factory settings, the LED display (LED1, LED2) works according to the following table:

Operating state	State	Meaning
There is no valid target value.	Both LEDs off	
There is a valid target value.	LED1 red	Display data not acknowledged.
	LED1 green	Display data acknowledged.
	LED2 red	Target value not acknowledged.
	LED2 green	Target value acknowledged.

Table 6: Status LED display in the alpha-numeric display operating mode

3.1.2.1 ControlWord: Alpha-numeric display

The ControlWord differs in function depending on operating mode.

The designation of the individual bits of the ControlWord as well as their meaning:

Bit	Meaning	Value = 0	Value = 1
0	bc00_Reserved	ever 0	-
1	bc01_Reserved	ever 0	-
2	bc02_DisplayDataActive (display line 1)	-	Activate upper line display
3	bc03_DisplayRange	Normal display area	Extended display area
4	bc04_GuardingBit	is mirrored in StatusWord	is mirrored in StatusWord
5	bc05_ErrorAck	-	Acknowledge error
6	bc06_TargetValueAckMode (display line 2)	Manually acknowledge target value	Acknowledge target value
7	bc07_TargetValueTypeSelect (display line 2)	Interpret target value as a number	Interpret target value as ASCII character
8	bc08_DisplayDataTypeSelect (display line 1)	Interpret display data as a number	Interpret display data as ASCII character
9	bc09_TargetValueActive (display line 2)	-	Activate bottom line display
10	bc10_DisplayDataAckMode (display line 1)	Manually acknowledge target value	Acknowledge target value
11	bc11_Led1Green	Release via LED parameters required	Deactivate LED
12	bc12_Led1Red		Activate LED
13	bc13_Led2Green		Deactivate LED
14	bc14_Led2Red		Activate LED
15	bc15_LedBlinking		Deactivate LED
			Activate LED

Table 7: ControlWord alpha-numeric display operating mode

3.1.2.2 StatusWord: Alpha-numeric display

The Status Word shows the current status of the AP05.



The designation of the individual bits of the StatusWord as well as their meaning:

Bit	Meaning	Value= 0	Value= 1
0	bs00_Reserved	ever0	-
1	bs01_Reserved	ever0	-
2	bs02_DisplayDataActive (display line 1)	DisplayData is not activated	DisplayData is activated
3	bs03_TargetValueAck (display line 2)	Target value not acknowledged	Target value acknowledged
4	bs04_GuardingBit	mirrored from ControlWord	mirrored from ControlWord

Bit	Meaning	Value= 0	Value= 1
5	bs05_DisplayDataAck (display line 1)	DisplayData not acknowledged	DisplayData acknowledged
6	bs06_Reserved	ever0	-
7	bs07_GeneralError	No error	An error exists
8	bs08_DisplayDataType (display line 1)	DisplayData are interpreted as a number	DisplayData are interpreted as an ASCII character
9	bs09_TargetValueType (display line 2)	Target value is interpreted as a number	Target value is interpreted as an ASCII character
10	bs10_TargetValueState (display line 2)	Target value is not activated	Target value is activated
11	bs11_BatteryState	Battery Charging state is OK	Battery Charging state is critical
12	bs12_SpeedError	There is no SpeedError	There is a SpeedError
13	bs13_KeyConfiguration	Button is not pressed	Button is pressed
14	bs14_KeyCalibration	Button is not pressed	Button is pressed
15	bs15_KeyIncremental	Button is not pressed	Button is pressed

Table 8: StatusWord alpha-numeric display operating mode

3.2 Battery buffering

Without an external power supply, encoder changes are recorded with battery support. Depending on the duration of battery operation (including storage) and the frequency of adjustments without an external power supply, the battery life is approximately 8 years. Battery voltage is checked at intervals of approx. 10 min. If battery voltage drops below a specified value, the battery symbol  will blink on the display. If the battery voltage continues to drop,  will be displayed permanently. The battery should be replaced within approx. three months after the first appearance of the battery symbol. For battery replacement it is mandatory to follow the instructions of the installation instructions. Replacement can also take place at the SIKO distribution partners or in the SIKO main plant.

Behavior of the StatusWord:

The charge status of the battery is signified in the StatusWord. In the case of a critical charging voltage, bs11_BatteryState is set, and in the case of an empty or non-existing battery, a fault is additionally signaled with bs07_GeneralError.

3.3 Parameterization of the position indicator

The position indicator can be fully parameterized via the IO-Link interface. All parameters can also be set manually with the help of the keyboard.

3.3.1 Manual parameterization



3.3.1.1 Starting parameterization

The time until menu release is displayed when the  button is pressed. Parameterization starts if it is actuated for the duration of the enable time (see chapter 2.3 and 4.5.1).

3.3.1.2 Value input

NOTICE

When you enter values via the keys, the display range is limited to -199999 ... 999999. If values beyond this range are entered via the interface, "FULL" will be displayed when the parameter is called up.



Enter values via the  key and the  key.
Confirm values entered by pressing the  key.

 - decimal place selection key

 - value input key

3.3.1.3 Value selection

For some parameters you can select values from a list. Direct value input is not possible there.

Pressing the  key, the value can be selected from the list. By pressing the  key, the selection is confirmed.

3.3.1.4 Overview of the operating menu

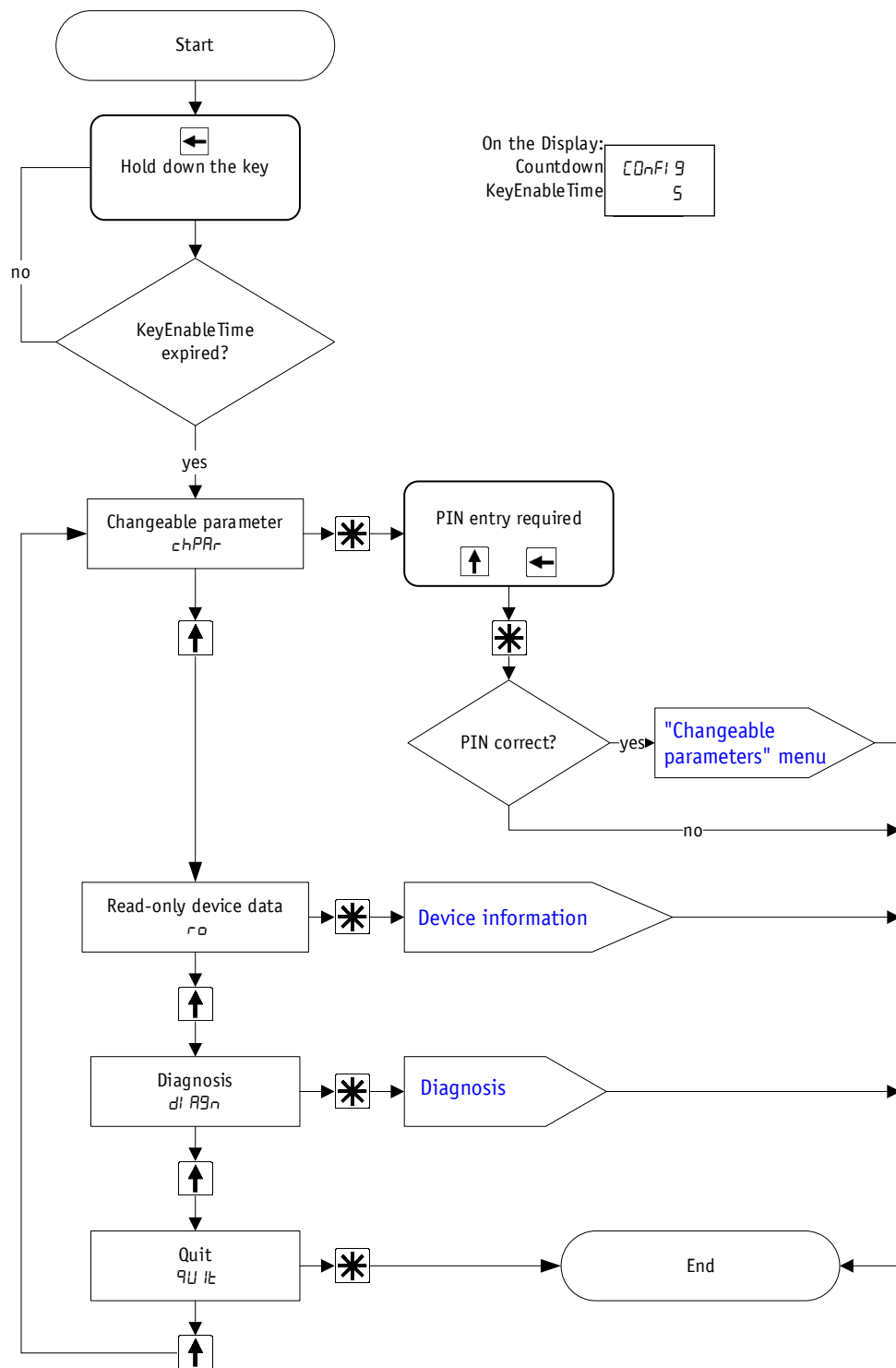

Fig. 5: Menu selection

3.3.1.5 "Changeable parameters" menu

The "Changeable parameters" menu is structured as follows:

Description	Display	Page
Positioning	POSIT	17
Visualization	VISI0	17
LED function	LED	18
Device options	OPTI0	18

Table 9: "Changeable parameters" menu structure

3.3.1.6 Positioning

The following parameters can be set in the "Positioning" menu:

Description	Display	Chapter
Resolution	RESOL	4.2.1
DecimalPlaces	dP	4.2.2
DisplayDivisor	ddi U	4.2.3
CountingDirection	count	4.2.4
CalibrationValue	CALIB	4.2.5
Calibration selection	CALIB YES no	3.4
TargetWindow	TARGI	4.2.6
LoopType	LOOP	4.2.7
LoopLength	LOOPL	4.2.8

Table 10: "Positioning" menu

3.3.1.7 Visualization

The following parameters can be set in the "Visualization" menu:

Description	Display	Chapter
DisplayOrientation	di SPL	4.3.1

Table 11: "Visualization" menu

3.3.1.8 LED function

The following parameters can be set in the "LED function" menu:

Description	Display	Chapter
Led1GreenMode	Grn 1	4.4.2
Led2GreenMode	Grn 2	4.4.3
Led1RedMode	rEd 1	4.4.4
Led2RedMode	rEd 2	4.4.5
ActiveLedsFlashing	FLASH	4.4.6

Table 12: "LED function" menu

3.3.1.9 Device options

The following parameters can be set in the "Additional device options" menu:

Description	Display	Chapter
KeyEnableTime	dELAY	4.5.1
KeyCalibration	CALEn	4.5.2
KeyIncremental	IncEn	4.5.3
OperatingMode	OPtYP	4.5.4
PinChange	Pin	4.5.5
LoadDefault	LOADP	4.5.6
CODE	COdE	4.5.7

Table 13: "Additional device options" menu

3.3.2 Parameterization via interface

The position indicator can be completely parameterized in the IO-Link interface (see chapter [5.2](#)).

3.4 Calibration

NOTICE	Calibration is only possible if the chain dimension is not active and the actual value is not 0.
---------------	--

Two steps are required for executing calibration:

- Write calibration value: Parameter CalibrationValue (see chapter [4.2.5](#)).
- Execute calibration (using operating keys, see chapter [2.3](#) and [3.3.1](#) or SystemCommand see chapter [5.3](#) or ControlWord see chapter [5.1.1.1](#)).

During calibration using the control buttons, a countdown of 5 seconds is started and displayed. Calibration is completed after the countdown.

During calibration, the calibration value is used to calculate the actual value. The following applies at this time:

Actual value = $\text{ActualValue} = 0 + \text{CalibrationValue}$

Since the measuring system is an absolute system, calibration is necessary only once with commissioning.

3.5 Additional functions

3.5.1 Device information

The following values can be read in the "Read Only" menu:

Description	Display	Chapter
BatteryVoltage	U B A t t	
DeviceTemperature	t c	
Actual CalibrationValue	CAL i b	4.2.5
CustomizedOperatingTime	O t c	
TotalOperatingTime	O t t	
FirmwareRevision	S O F t	5.2.1
HardwareRevision	H A R d	
SerialNumber	S E r n o	

Table 14: "Device data" menu

3.5.2 Diagnosis

The AP05 features various diagnostic options, which can be selected from the "Diagnosis" submenu. The following diagnostic options are differentiated:

Description	Display
Reading the error memories	E r r o r
Presentation	P r e s e n t

Table 15: "Diagnosis" menu

3.5.2.1 Reading the error memories

Two different error histories can be output here.

The "AP05" list contains errors found by the device such as "Low battery voltage" or "Velocity exceeded".

With errors occurring, the error number and overall quantity are output on the upper line. The type of error appears in the lower line, with error number 1 containing the latest error. The oldest error is output with the highest error number. "n**O**E**r**r" appears if no errors have been detected so far.

All error memories and error counters are deleted when the factory settings are restored (see chapter 3.5.3).

3.5.2.2 Presentation

In presentation mode, specific parameters and a fixed set point (850) are set and validated. So, the mode of operation of the device can be presented without the need of specifying a set point via an interface. As soon as the device is restarted or process data are exchanged with an IO-Link master, the presentation is finished.

3.5.3 Restore factory settings

There are various options for restoring the factory settings of the device:

Access	Coding		Factory settings are restored
Manual	CODE (see chapter 4.5.7)	011100	all parameters
	Load Default (see chapter 4.5.6)	ALL	all parameters
Interface	SystemCommands (see chapter 5.3)	130 (82h)	all parameters

Table 16: Access to factory settings

3.5.4 Operation hours counter

Various operating hours counters are in operation in the AP05.

3.5.4.1 General operating hours counter

Detects the time during which the device is sufficiently supplied via the connection line and is therefore in operation. Operating mode and state are irrelevant. This counter cannot be deleted or reset.

General characteristics

EEPROM	yes
Unit	Hours
Value range	0 ... 87600 (10 years)
Memory accuracy	10 min

IO-Link

Data type	-		
Access	-		
Index	-	-	-
Data Storage	-		

Display

Menu	<code>ro \DE t\</code>
Delete	-

3.5.4.2 Customer-specific operating hours counter

Detects the time during which the device is sufficiently supplied via the connection line and is therefore in operation. Operating mode and state are irrelevant. This counter can be deleted or set to 0 by the user.

Resolution: 1h, memory accuracy 10 min, display in the ReadOnly menu, can be deleted via "CODE 50000" and reset to factory settings.

EEPROM	yes
Unit	Hours
Value range	0 ... 87600 (10 years)
Memory accuracy	10 min

IO-Link

Data type	-		
Access	-		
Index	-	-	-
Data Storage	-		

Display

Menu	<code>ro \DE t\</code>
Delete	<code>chPAR \OPTI 0\ CODE 50000</code>

3.6 Warnings / Errors

3.6.1 Warnings

Warnings have no influence on the recording of the actual value.

Warnings are deleted after removing the cause.

The cause of the error can be determined based on the error code (see chapter 5.5).

Possible warnings:

- Battery voltage for absolute position detection is below limit ⇒ immediately exchange battery!
This warning is displayed with a blinking battery symbol. Warning messages are output via the interface via an IO-Link event and the StatusWord (see chapter 3.5.1, chapter 5.1.1.2 and chapter 5.5).



Display	Bit assignment in the StatusWord	Error
 flashing	bs11_BatteryState	Low battery voltage (critical) PositionValue is still valid!

Table 17: Warnings

3.6.2 Errors

NOTICE	Calibration may also be required Depending on the error type.
---------------	---

Error states are signaled via display (written in red or battery symbol) and interface. The cause of the fault can be determined using the event or error code (see chapter 5.5 and 5.6). To return to normal operation, the cause must be removed (see Table 18). Error signaling can then be acknowledged or deleted with the  - Taste (see chapter 2.3) key.

(For signaling see chapter 2.1.)

Display	Bit assignment in the StatusWord	Error
 permanent	bs11_BatteryState + bs07_GeneralError	Battery undervoltage (dead)
<i>SPEED</i>	bs12_SpeedError + bs07_GeneralError	Travel speed exceeded

Table 18: Error messages in the display

3.6.2.1 Error memory

All occurring error messages are entered in the error memory in the sequence in which they are recorded. When the error memory is full, the last 10 error messages are displayed. Error memory is deleted when the factory settings are restored.

The stored errors can be output in the diagnostic function (see chapter 3.5.2.1) via the LCD display. The display has the following meaning:

In the 1st line shows the current error and the total number of stored errors.

2nd line:

Display	Error
<i>bAtLo</i>	Battery dead
<i>SPEED</i>	Permissible travel speed exceeded
<i>SEnbd</i>	Sensor error, magnetic field faulty
<i>noSEn</i>	Sensor error, reading head faulty
<i>SEnSr</i>	Sensor error, SIN COS monitoring
<i>SEnI C</i>	Sensor error, internal error
<i>StorE</i>	Data memory faulty

3.6.2.2 Error counter

There is an associated error counter for each error type. The error counters are reset when the factory settings are restored. The number of error types and the respective number of errors can be output via the IO-Link interface (see chapter 4.6).

3.6.3 Corrective actions

Display	Error	Possible effect	Corrective actions
□ permanent	Battery empty	Actual value not reliable	Battery change
			If applicable, calibration required after error correction and acknowledgment.
SPEED	Permissible speed exceeded (see installation instruction)	Actual value not reliable	Traversing speed
			Check EMC measures
			Calibration
All other		actual values not reliable	Check EMC measures
			Restart device, restore factory settings, parameterize again.
			Calibration may be required
			Device testing at SIKO

Table 19: Corrective actions

3.7 Adjustment run (already carried out at the factory for AP05)

The AP05 position indicator is fully functional at delivery. For a complete description of the product, the adjustment process is described here.

When you enter the CODE 00100 or via the corresponding IO-Link SystemCommand, the adjustment process is started (see chapter 3.3.1.9 and 5.3).

Display: 1st line "ADJUST"

2nd line "100" this value can vary by ± 1 .

Now the shaft must be rotated clockwise by a few millimeters (speed $\ll 1$ rpm).

The value changes in the positive direction up to "103" in the lower line.

If this value is exceeded in the end, the adjustment process has been completed. The AP05 is back in normal operation and shows the corresponding display. If values above "103" are displayed during the adjustment, the travel speed must be reduced during the adjustment.

It is not unusual for the position value initially not be displayed after the adjustment run; "FULL" is displayed instead of the value. The display must then be calibrated (see chapter 3.4).

4 Parameter

All parameters stored in the EEPROM can be reset to factory default settings if necessary (see chapter [3.5.2](#)).

Chapter	Starting with page
Process data	24
Positioning	26
Visualization	31
LEDs	31
Device options	34

4.1 Process data

4.1.1 ControlWord

General characteristics

EEPROM	no
Unit	-
Value range	See chapter 5.1
Default	0

IO-Link

Data type	UnsignedInteger16		
Access	wo		
Index	-	Sub-index	-
Data Storage	no		

4.1.2 StatusWord

General characteristics

EEPROM	no
Unit	-
Value range	See chapter 5.1
Default	0

IO-Link

Data type	UnsignedInteger16		
Access	ro		
Index	70	Sub-index	0
Data Storage	no		

4.1.3 TargetValue

General characteristics

EEPROM	no
Unit	-

IO-Link

Data type	SignedInteger32		
Access	rw		
Index	69	Sub-index	0
Data Storage	no		
Value range	-2147483648 ... 2147483647 (+/- 7FFFFFFh)		
Default	0		

Display

Value range	-19999 ... 99999
-------------	------------------

4.1.4 ActualValue

General characteristics

EEPROM	no
Unit	-

IO-Link

Data type	SignedInteger32		
Access	ro		
Index	68	Sub-index	0
Data Storage	no		
Value range	-2147483648 ... 2147483647		
Default	0		

Display

Value range	-19999 ... 99999
-------------	------------------

4.1.5 DisplayData

General characteristics

EEPROM	no
Unit	-
Value range	0 ... FFh, FFh, FFh, FFh, FFh
Default	-

IO-Link

Data type	OctetString5		
Access	rw		
Index	95	Sub-index	0
Data Storage	no		

4.1.6 TargetValueLeft

General characteristics

EEPROM	no
Unit	-
Value range	2 characters
Default	-

IO-Link

Data type	OctetString2		
Access	wo		
Index	-	Sub-index	-
Data Storage	no		

4.2 Positioning

4.2.1 Resolution

General characteristics

EEPROM	yes
Unit	-
Default	720

IO-Link

Data type	UnsignedInteger32		
Access	rw		
Index	72	Sub-index	0
Data Storage	yes		
Value range	1 ... 2147483647 (1h ... 7FFFFFFh)		

Display

Menu	<code>chPAr \POS1 \rESOL</code>
Value range	1 ... 99999

4.2.2 DecimalPlaces

General characteristics

EEPROM	yes
Unit	-
Value range	0 ... 4
Default	0

IO-Link

Data type	UnsignedInteger8		
Access	rw		
Index	73	Sub-index	0
Data Storage	yes		

Display

Menu	<code>chPAr \POS1 \dP</code>
------	------------------------------

Parameter selection

Value	Display	Description
0	<code>0</code>	0
1	<code>0.1</code>	1 decimal place
2	<code>0.12</code>	2 decimal places
3	<code>0.123</code>	3 decimal places
4	<code>0.1234</code>	4 decimal places

4.2.3 DisplayDivisor

General characteristics

EEPROM	yes
Unit	-
Value range	0 ... 3
Default	0

IO-Link

Data type	UnsignedInteger8		
Access	rw		
Index	74	Sub-index	0
Data Storage	yes		

Display

Menu	<code>chPAR \ POSI \ ddi U</code>
------	-----------------------------------

Parameter selection

Value	Display	Description
0	1	Division by 1
1	10	Division by 10
2	100	Division by 100
3	1000	Division by 1000

4.2.4 CountingDirection

General characteristics

EEPROM	yes
Unit	-
Value range	0 ... 1
Default	0

IO-Link

Data type	UnsignedInteger8 / Bool		
Access	rw		
Index	76	Sub-index	0
Data Storage	yes		

Display

Menu	<code>chPAR \ POSI \ Cntdi r</code>
------	-------------------------------------

Parameter selection

Value	Display	Description
0	CR	Sense of rotation clockwise Increasing actual values with clockwise rotation
1	CCR	Sense of rotation counter clockwise Increasing actual values with counterclockwise rotation

4.2.5 CalibrationValue

General characteristics

EEPROM	yes
Unit	-
Value range	-19999 ... 99999
Default	0

IO-Link

Data type	SignedInteger32		
Access	rw		
Index	77	Sub-index	0
Data Storage	yes		

Display

Menu	CHPAR \ POSI \ CALI b
------	-----------------------

4.2.6 TargetWindow

General characteristics

EEPROM	yes
Unit	User units
Value range	0 ... 9999
Default	5

IO-Link

Data type	UnsignedInteger16		
Access	rw		
Index	78	Sub-index	0
Data Storage	yes		

Display

Menu	CHPAR \ POSI \ TARG I
------	-----------------------

4.2.7 LoopType

General characteristics

EEPROM	yes
Unit	-
Value range	0 ... 2
Default	0

IO-Link

Data type	UnsignedInteger8		
Access	rw		
Index	79	Sub-index	0
Data Storage	yes		

Display

Menu	<code>chPAR \ POSI \ LOOP</code>
------	----------------------------------

Parameter selection

Value	Display	Description
0	<code>direct</code>	The target value is approached directly from the current position.
1	<code>POS</code>	To compensate for the spindle play, the target value is always approached in the positive direction.
2	<code>NEG</code>	To compensate for the spindle play, the target value is always approached in the negative direction.

4.2.8 LoopLength

General characteristics

EEPROM	yes
Unit	-
Value range	0 ... 9999
Default	0

IO-Link

Data type	UnsignedInteger16		
Access	rw		
Index	80	Sub-index	0
Data Storage	yes		

Display

Menu	<code>chPAR \ POSI \ LOOPL</code>
------	-----------------------------------

4.3 Visualization

4.3.1 DisplayOrientation

General characteristics

EEPROM	yes
Unit	-
Value range	0 ... 1
Default	0

IO-Link

Data type	UnsignedInteger8/Bool		
Access	rw		
Index	83	Sub-index	0
Data Storage	yes		

Display

Menu	<code>chPPr \ POSI \ dl SPL</code>
------	------------------------------------

Parameter selection

Value	Display	Description
0	<code>0</code>	Orientation 0°
1	<code>180</code>	Orientation 180°

4.4 LEDs

4.4.1 LEDMode

General characteristics

EEPROM	yes
Unit	-
Value range	0 ... see sub-indexes
Default	15

IO-Link

Data type	UnsignedInteger8		
Access	rw		
Index	86	Sub-index	0
Data Storage	yes		

4.4.2 Led1GreenMode

General characteristics

EEPROM	yes
Unit	-
Value range	0 ... 1
Default	1

IO-Link

Data type	Bool		
Access	rw via LEDMode: Index 86; Sub-index 0; Bit0		
Index	86	Sub-index	1
Data Storage	yes		

Display

Menu	<code>chPAR \LEd5 \Grn 1</code>
------	---------------------------------

Parameter selection

Value	Display	Description
0	<code>OFF</code>	Depending on the ControlBit
1	<code>On</code>	Depending on the device status (see chapter 3.1)

4.4.3 Led2GreenMode

General characteristics

EEPROM	yes
Unit	-
Value range	0 ... 1
Default	1

IO-Link

Data type	Bool		
Access	rw via LEDMode: Index 86; Sub-index 0; Bit1		
Index	86	Sub-index	2
Data Storage	yes		

Display

Menu	<code>chPAR \LEd5 \Grn 2</code>
------	---------------------------------

Parameter selection

Value	Display	Description
0	<code>OFF</code>	Depending on the ControlBit
1	<code>On</code>	Depending on the device status (see chapter 3.1)

4.4.4 Led1RedMode

General characteristics

EEPROM	yes
Unit	-
Value range	0 ... 1
Default	1

IO-Link

Data type	Bool		
Access	rw via LEDMode: Index 86; Sub-index 0; Bit2		
Index	86	Sub-index	3
Data Storage	yes		

Display

Menu	<code>chPAR \LEd5 \rEd 1</code>
------	---------------------------------

Parameter selection

Value	Display	Description
0	<code>OFF</code>	Depending on the ControlBit
1	<code>On</code>	Depending on the device status (see chapter 3.1)

4.4.5 Led2RedMode

General characteristics

EEPROM	yes
Unit	-
Value range	0 ... 1
Default	1

IO-Link

Data type	Bool		
Access	rw via LEDMode: Index 86; Sub-index 0; Bit3		
Index	86	Sub-index	4
Data Storage	yes		

Display

Menu	<code>chPAR \LEd5 \rEd 2</code>
------	---------------------------------

Parameter selection

Value	Display	Description
0	<code>OFF</code>	Depending on the ControlBit
1	<code>On</code>	Depending on the device status (see chapter 3.1)

4.4.6 ActiveLedsFlashing

General characteristics

EEPROM	yes
Unit	-
Value range	0 ... 1
Default	1

IO-Link

Data type	Bool		
Access	rw via LEDMode: Index 86; Sub-index 0; Bit4		
Index	86	Sub-index	5
Data Storage	yes		

Display

Menu	<code>chPAR \LED5 \FLASH</code>
------	---------------------------------

Parameter selection

Value	Display	Description
0	<code>OFF</code>	Depending on the ControlBit (see bc15_LedBlinking)
1	<code>On</code>	Depending on the device status (see chapter 3.1)

4.5 Device options

4.5.1 KeyEnableTime

General characteristics

EEPROM	yes
Unit	s

IO-Link

Data type	-		
Access	No access		
Index	-	Sub-index	-
Data Storage	-		

Display

Menu	<code>chPAR \OPTIO \DELAY</code>
Value range	1 ... 60
Default	5

4.5.2 KeyCalibration

General characteristics

EEPROM	yes
Unit	-
Value range	0 ... 1
Default	1

IO-Link

Data type	UnsignedInteger8 / Bool		
Access	rw		
Index	88	Sub-index	0
Data Storage	yes		

Display

Menu	chPAR \ OPTI 0 \ CAL En
------	-------------------------

Parameter selection

Value	Display	Description
0	OFF	Functions disabled via key
1	ON	Functions enabled via key

4.5.3 KeyIncremental

General characteristics

EEPROM	yes
Unit	-
Value range	0 ... 1
Default	1

IO-Link

Data type	UnsignedInteger8 / Bool		
Access	rw		
Index	89	Sub-index	0
Data Storage	yes		

Display

Menu	chPAR \ OPTI 0 \ IN En
------	------------------------

Parameter selection

Value	Display	Description
0	OFF	Functions disabled via key
1	On	Functions enabled via key

4.5.4 OperatingMode

General characteristics

EEPROM	yes
Unit	-
Value range	0 ... 1
Default	0

IO-Link

Data type	UnsignedInteger8		
Access	rw		
Index	92	Sub-index	0
Data Storage	yes		

Display

Menu	<code>chPAR \OPTI 0 \OPTYP</code>
------	-----------------------------------

Parameter selection

Value	Display	Description
0	<code>ABS</code>	Absolute position
1	<code>di SPL</code>	Alpha-numeric display

4.5.5 PinChange

PIN required to change parameters via buttons and display.

General characteristics

EEPROM	yes
Unit	-
Value range	0 ... 99999
Default	0

IO-Link

Data type	UnsignedInteger32		
Access	rw		
Index	67	Sub-index	0
Data Storage	yes		

Display

Menu	<code>chPAR \OPTI 0 \PIN</code>
------	---------------------------------

4.5.6 LoadDefault

General characteristics

EEPROM	yes
Unit	-

Display

Menu	<code>chPAR \OPTI 0 \LOADP</code>
------	-----------------------------------

Parameter selection

Value	Display	Description
0	<code>n0</code>	No function
1	<code>ALL</code>	Reset all parameters to factory settings

4.5.7 CODE

General characteristics

EEPROM	no
Unit	-

Display

Menu	<code>chPAR \OPTI 0 \COdE</code>
------	----------------------------------

Parameter selection

Value	SystemCommand	Description
0	-	No function
00100	160	Start adjustment
10101	-	Start Presentation mode
11100	130	Reset all parameters to factory settings
50000	-	Reset customer-specific operating hours counter

4.6 Error counter

General characteristics

EEPROM	yes
Unit	-
Value range	7
Default	7

IO-Link

Data type	UnsignedInteger8		
Access	ro		
Index	186	Sub-index	0
Data Storage	no		

4.6.1 Event counter for the error "Battery dead"

General characteristics

EEPROM	yes
Unit	-
Value range	0 ... 255
Default	0

IO-Link

Data type	UnsignedInteger8		
Access	ro		
Index	186	Sub-index	1
Data Storage	no		

Parameter selection

Value	Description
0 ... 255	Number of newly detected errors of this type that have occurred

4.6.2 Event counter for the error "Permissible travel speed exceeded"

General characteristics

EEPROM	yes
Unit	-
Value range	0 ... 255
Default	0

IO-Link

Data type	UnsignedInteger8		
Access	ro		
Index	186	Sub-index	2
Data Storage	no		

Parameter selection

Value	Description
0 ... 255	Number of newly detected errors of this type that have occurred

4.6.3 Event counter for the error "Sensor error, magnetic field faulty"

General characteristics

EEPROM	yes
Unit	-
Value range	0 ... 255
Default	0

IO-Link

Data type	UnsignedInteger8		
Access	ro		
Index	186	Sub-index	3
Data Storage	no		

Parameter selection

Value	Description
0 ... 255	Number of newly detected errors of this type that have occurred

4.6.4 Event counter for the error "Sensor error, reader head faulty"

General characteristics

EEPROM	yes
Unit	-
Value range	0 ... 255
Default	0

IO-Link

Data type	UnsignedInteger8		
Access	ro		
Index	186	Sub-index	4
Data Storage	no		

Parameter selection

Value	Description
0 ... 255	Number of newly detected errors of this type that have occurred

4.6.5 Event counter for the error "Sensor error, SIN COS Monitoring"

General characteristics

EEPROM	yes
Unit	-
Value range	0 ... 255
Default	0

IO-Link

Data type	UnsignedInteger8		
Access	ro		
Index	186	Sub-index	5
Data Storage	no		

Parameter selection

Value	Description
0 ... 255	Number of newly detected errors of this type that have occurred

4.6.6 Event counter for the error "Sensor error, internal error3"

General characteristics

EEPROM	yes
Unit	-
Value range	0 ... 255
Default	0

IO-Link

Data type	UnsignedInteger8		
Access	ro		
Index	186	Sub-index	6
Data Storage	no		

Parameter selection

Value	Description
0 ... 255	Number of newly detected errors of this type that have occurred

4.6.7 Event counter for the error "Sensor error, internal error4"

General characteristics

EEPROM	yes
Unit	-
Value range	0 ... 255
Default	0

IO-Link

Data type	UnsignedInteger8		
Access	ro		
Index	186	Sub-index	7
Data Storage	no		

Parameter selection

Value	Description
0 ... 255	Number of newly detected errors of this type that have occurred

5 IO-Link

The device description is available for download as IODD at www.siko-global.com and in the IODD finder of the IO-Link Community.

IO-Link Version	V1.1
SIO-Mode	No
Port	Class A
COM-Mode	COM2 (38.4 kbits/s)
Min Cycle Time	9.2 ms
Process Data In	8 Byte
Process Data Out	8 Byte
Data Storage	Yes
Block parameters	Yes

Table 20: General Interface Information

5.1 Process data input / output

All process data are displayed within 8 bytes and have different significance depending on the operating mode.

Transmission sequence:



Byte	0	1	2	3	4	5	6	7
Sub-index	18 ... 11	10 ... 3	2		1			
Bit Offset	63 ... 56	55 ... 48	47 ... 40	39 ... 32	31 ... 24	23 ... 16	15 ... 8	7 ... 0

Table 21: Assignment of transfer sequence, sub-index and bit offset

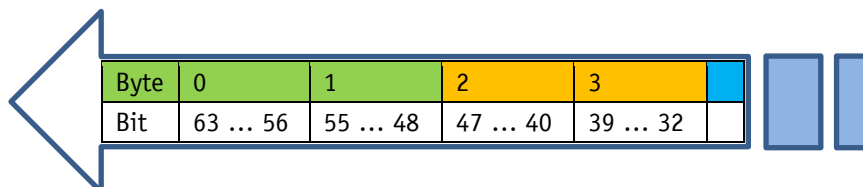

Fig. 6: Transmission sequence

Structure of Process Data				
Port	Name	Data Type	Address	
1	PDI_AbsoluteMode - bs08_Reserved	Bool	%I 1.0	
1	PDI_AbsoluteMode - bs09_IncrementalMeasurement	Bool	%I 1.1	
1	PDI_AbsoluteMode - bs10_TargetValueState	Bool	%I 1.2	
1	PDI_AbsoluteMode - bs11_BatteryState	Bool	%I 1.3	
1	PDI_AbsoluteMode - bs12_SpeedError	Bool	%I 1.4	
1	PDI_AbsoluteMode - bs13_KeyConfiguration	Bool	%I 1.5	
1	PDI_AbsoluteMode - bs14_KeyCalibration	Bool	%I 1.6	
1	PDI_AbsoluteMode - bs15_KeyIncremental	Bool	%I 1.7	
1	PDI_AbsoluteMode - bs00_IndicatorCW	Bool	%I 2.0	
1	PDI_AbsoluteMode - bs01_IndicatorCCW	Bool	%I 2.1	
1	PDI_AbsoluteMode - bs02_CalibrationExecuted	Bool	%I 2.2	
1	PDI_AbsoluteMode - bs03_Reserved	Bool	%I 2.3	
1	PDI_AbsoluteMode - bs04_GuardingBit	Bool	%I 2.4	
1	PDI_AbsoluteMode - bs05_TargetWindowReached	Bool	%I 2.5	
1	PDI_AbsoluteMode - bs06_Deviation	Bool	%I 2.6	
1	PDI_AbsoluteMode - bs07_GeneralError	Bool	%I 2.7	
1	PDI_AbsoluteMode - Reserved	Word	%IW 3	
1	PDI_AbsoluteMode - PositionValue	DInt	%ID 5	
1	PDI_AbsoluteMode - bs08_Reserved	Bool	%I 1.0	

Fig. 7: Example representation in IO-Link master

5.1.1 Process data in Absolute position operating mode

Sub-index	Significance (Absolute Position operating mode)		Bit offset	Octet	Length
	In (to master)	Out (from master)			
1	PositionValue	TargetValue	0	4 ... 7	32
2	Reserviert	Reserviert	32	2 ... 3	16
3 ... 18	StatusWord	ControlWord	48	0 ... 1	16

Table 22: Process data definition

5.1.1.1 Process data output (master ⇒ device)

Sub-index	Name	Bit offset	Bit length	Data type	Comment
1	TargetValue	0	32	Signed-Integer	Absolute target value
2	Reserved	32	16	-	Used in DisplayMode
3	bc00_CalibrationExecute	48	1	Bool	If true calibration becomes executed
4	bc01_Reserved	49	1	Bool	
5	bc02_Reserved	50	1	Bool	Used in DisplayMode
6	bc03_DisplayRange	51	1	Bool	If true display range is extended
7	bc04_GuardingBit	52	1	Bool	Communication guarding

Sub-index	Name	Bit offset	Bit length	Data type	Comment
8	bc05_ErrorAck	53	1	Bool	If true the actual error is acknowledged
9	bc06_Reserved	54	1	Bool	Used in DisplayMode
10	bc07_Reserved	55	1	Bool	Used in DisplayMode
11	bc08_Reserved	56	1	Bool	Used in DisplayMode
12	bc09_TargetValueActive	57	1	Bool	If true TargetValue is active
13	bc10_Reserved	58	1	Bool	
14	bc11_Led1Green	59	1	Bool	If true LED is on. Function controlled via Parameter LEDMode
15	bc12_Led1Red	60	1	Bool	see bc11
16	bc13_Led2Green	61	1	Bool	see bc11
17	bc14_Led2Red	62	1	Bool	see bc11
18	bc15_LedBlinking	63	1	Bool	If true LEDs are blinking when on

Table 23: Process data output in Absolute position operating mode

5.1.1.2 Process data input (device ⇒ master)

Sub-index	Name	Bit offset	Bit length	Data type	Comment
1	PositionValue	0	32	Signed-Integer	Absolute position value
2	Reserved	32	16	-	
3	bs00_DirIndicationCW	48	1	Bool	True if indicator cw is on
4	bs01_DirIndicationCCW	49	1	Bool	True if indicator ccw is on
5	bs02_CalibrationExecuted	50	1	Bool	True if calibration was executed by command via interface
6	bs03_Reserved	51	1	Bool	Used in DisplayMode
7	bs04_GuardingBit	52	1	Bool	Communication guarding
8	bs05_TargetWindowReached	53	1	Bool	True if target window is reached
9	bs06_Deviation	54	1	Bool	Deviation from actual value to target
10	bs07_GeneralError	55	1	Bool	True if error occurred
11	bs08_Reserved	56	1	Bool	Used in DisplayMode
12	bs09_IncMeasurement	57	1	Bool	True if incremental measurement is active
13	bs10_TargetValueState	58	1	Bool	True if target value is active

Sub-index	Name	Bit offset	Bit length	Data type	Comment
14	bs11_BatteryState	59	1	Bool	True if battery state is critical or low
15	bs12_SpeedError	60	1	Bool	True if max speed was exceeded
16	bs13_KeyConfiguration	61	1	Bool	True if key is actuated
17	bs14_KeyCalibration	62	1	Bool	True if key is actuated
18	bs15_KeyIncremental	63	1	Bool	True if key is actuated

Table 24: Process data input in Absolute position operating mode

5.1.2 Process data in Alphanumeric display operating mode

Sub-index	Significance (Alphanumeric display operating mode)		Bit offset	Octet	Length
	In (to master)	Out (from master)			
1	ActualValue	TargetValue	0	4 ... 7	32
2	Reserviert	TargetValueLeft	32	2 ... 3	16
3 ... 18	StatusWord	ControlWord	48	0 ... 1	16

Table 25: Process data definition

5.1.2.1 Process data output (master ⇒ device)

Sub-index	Name	Bit offset	Bit length	Data type	Comment
1	TargetValue	0	32	Signed-Integer	Displayed value in bottom row (4 figures right)
2	TargetValueLeft	32	16	Unsigned Integer	Displayed value in bottom row (2 figures left)
3	bc00_Reserved	48	1	Bool	Used in AbsoluteMode
4	bc01_Reserved	49	1	Bool	If true DisplayData is active
5	bc02_DisplayDataActive	50	1	Bool	
6	bc03_DisplayRange	51	1	Bool	If true display range is extended
7	bc04_GuardingBit	52	1	Bool	Communication guarding
8	bc05_ErrorAck	53	1	Bool	If true the actual error is acknowledged
9	bc06_TargetValueAckMode	54	1	Bool	If true TargetValue becomes acknowledged
10	bc07_TargetValueTypeSelect	55	1	Bool	Format of TargetValue
11	bc08_DisplayDataTypeSelect	56	1	Bool	Format of DisplayData

Sub-index	Name	Bit offset	Bit length	Data type	Comment
12	bc09_TargetValueActive	57	1	Bool	If true TargetValue is active
13	bc10_DisplayDataAckMode	58	1	Bool	If true DisplayData becomes acknowledged
14	bc11_Led1Green	59	1	Bool	If true LED is on. Function controlled via Parameter LEDMode
15	bc12_Led1Red	60	1	Bool	see bc11
16	bc13_Led2Green	61	1	Bool	see bc11
17	bc14_Led2Red	62	1	Bool	see bc11
18	bc15_LedBlinking	63	1	Bool	If true LEDs are blinking when on

Table 26: Process data output in Alphanumeric display operating mode

5.1.2.2 Process data input (device ⇒ master)

Sub-index	Name	Bit offset	Bit length	Data type	Comment
1	PositionValue	0	32	Signed-Integer	Absolute position value
2	Reserved	32	16	-	
3	bs00_Reserved	48	1	Bool	Used in AbsoluteMode
4	bs01_Reserved	49	1	Bool	Used in AbsoluteMode
5	bs02_DisplayDataActive	50	1	Bool	True if DisplayData is active
6	bs03_TargetValueAck	51	1	Bool	True if TargetValue is acknowledged
7	bs04_GuardingBit	52	1	Bool	Communication guarding
8	bs05_DisplayDataAck	53	1	Bool	True if DisplayData is acknowledged
9	bs06_Reserved	54	1	Bool	Used in AbsoluteMode
10	bs07_GeneralError	55	1	Bool	True if error occurred
11	bs08_DisplayDataType	56	1	Bool	Format of DisplayData
12	bs09_TargetValueType	57	1	Bool	Format of TargetValue
13	bs10_TargetValueState	58	1	Bool	True if TargetValue is active
14	bs11_BatteryState	59	1	Bool	True if battery state is critical or low
15	bs12_SpeedError	60	1	Bool	True if speed limit is violated
16	bs13_KeyConfiguration	61	1	Bool	True if key is actuated
17	bs14_KeyCalibration	62	1	Bool	True if key is actuated

Sub-index	Name	Bit offset	Bit length	Data type	Comment
18	bs15_KeyIncremental	63	1	Bool	True if key is actuated

Table 27: Process data input in Alphanumeric display operating mode

5.2 Directory of objects

5.2.1 IO-Link specific objects

Index (hex)	Name	Type	Length	Access	Default	Comment
0 (00h)	DirectParameter1	Record	16 Byte	rw		See IO-Link Interface Spec.
1 (01h)	DirectParameter2	Record	16 Byte	rw		See IO-Link Interface Spec.
2 (02h)	SystemCommands			wo		See IO-Link Interface Spec. and 5.3
3 (03h)	DataStorageIndex	Record	72 Byte	ro		See IO-Link Interface Spec.
12 (0Ch)	DeviceAccessLocks	Record	2 Byte	wr		See IO-Link Interface Spec. and 5.4
13 (0Dh)	ProfileCharacteristic	Record	2 Byte	ro		See IO-Link Interface Spec.
14 (0Eh)	PDInputDescriptor	Unsigned Integer16	3 Byte	ro		See IO-Link Interface Spec.
15 (0Fh)	PDOOutputDescriptor	Unsigned Integer16	3 Byte	ro		See IO-Link Interface Spec.
16 (10h)	VendorName	String	9 Byte	ro	SIKO GmbH	
17 (11h)	VendorText	String	19 Byte	ro	www.siko-global.com	
18 (12h)	ProduktName	String	6 Byte	ro	_AP05_	
19 (13h)	ProduktID	String	1 Byte	ro	1	Connection EX
					2	Connection E12X
20 (14h)	ProduktText	String	37 Byte	ro	Absolute position indicator rotative	
21 (15h)	SerialNumber	String	7 Byte	ro	xxxxxxx	
22 (16h)	HardwareRevision	String	13 Byte	ro		
23 (17h)	FirmwareRevision	String	9 Byte	ro	FW-_V101_	
24 (18h)	ApplicationSpecific Tag	String	32 Byte	rw	***	See IO-Link Interface Spec.

Index (hex)	Name	Type	Length	Access	Default	Comment
36 (24h)	DeviceStatus	Uint	1 Byte	ro		See IO-Link Interface Spec.

Table 28: IO-Link specific indexes

5.3 SystemCommands

Index (hex)	Name	Access	Value	Name	Comment
2 (02h)	SystemCommands	wo	1	ParamUploadStart	IO-Link Spec.
			2	ParamUploadEnd	
			3	ParamDownloadStart	
			4	ParamDownloadEnd	
			5	ParamDownloadStore	
			6	ParamBreak	
			128	Device Reset	
			130	Restore factory settings	
					160
		161	Enable bootloader	Bootloading not via IO-Link	
		252	Execute calibration	See chapter 3.4	

Table 29: SystemCommands

5.4 DeviceAccessLocks

Index (hex)	Name	Access	Supported Access Locks	Comment
12 (0Ch)	DeviceAccessLocks	rw	Data Storage	IO-Link Spec.
			Local Parameterization	IO-Link Spec.

Table 30: DeviceAccessLocks

5.5 EventCodes

See also chapter 3.6.2.

Value	Name	Type	Comment
6145 (1801h)	Speed error	Error	Travel speed exceeded
6146 (1802h)	Battery empty	Error	Battery undervoltage (dead)
6158 (180Eh)	Internal error 3	Error	Sensor error, internal error3
6159 (180Fh)	Internal error 4	Error	Sensor error, internal error4

Value	Name	Type	Comment
20498 (5012h)	Battery low	Warning	Charging state "critical"
25376 (6320h)	Parameter error	Error	Data memory faulty, IO-Link Spec.

Table 31: EventCodes

5.6 ErrorCodes

Value 1 st Byte	Value 2 nd Byte	Name	Comment
80	xx	Error Code	IO-Link Spec. V1.1.2 Annex D
	00	Device application error, no details	
	11	Index not available	
	12	Subindex not available	
	20	Service temporarily not available	
	21	Service temporarily not available, local control	
	22	Service temporarily not available, device control	
	23	Write access denied	
	30	Parameter value out of range	
	31	Parameter value above limit	
	32	Parameter value below limit	
	33	Parameter length overrun	
	34	Parameter length underrun	
	35	Function not available	
	36	Function temporarily not available	
	40	Invalid parameter set	
	41	Inconsistent parameter set	
	82	Application not ready	
81	xx	Vendor specific error code	

Table 32: Error codes

6 Block diagram

Fig. 8: Block diagram



SIKO GmbH

Weihermattenweg 2
79256 Buchenbach

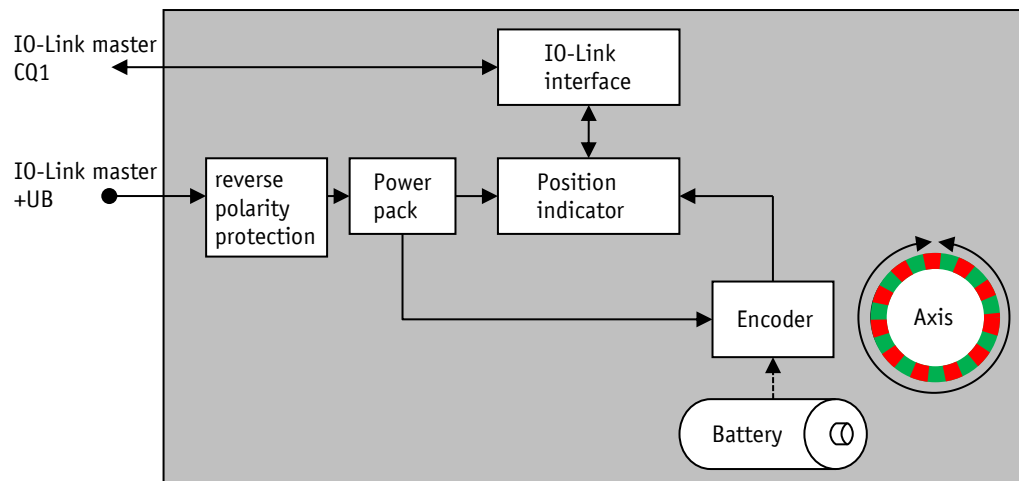
Phone

+ 49 7661 394-0

Fax

+ 49 7661 394-388

E-Mail

info@siko-global.com

Internet

www.siko-global.com

Service

support@siko-global.com